

RADIO LINX



RadioLinx Wireless Modems

Table of Contents

Product Overview	5
Summary of Function and Use	5
Regulatory Approvals	6
FCC Part 15 & Industry Canada Rules	6
COMPLIANCE STATEMENT	6
CSA C22.2 213-M13987 & cUL Standard 1604 Listing	7
European CE Certification	9
Antenna Spacing Requirements - User Safety	10
Getting Started	11
System Overview	11
The Setup / Diagnostic Software	12
Functional Conventions	13
Radio Networks	15
Radio Network Defined	15
Network Types	16
Network Types	16
Protocol Transparent Network	17
Modbus RTU & Modbus ASCII	19
RadioLinx OEM Protocol Network	21
DNP Protocol	22
Dialup Modem Emulation Network	23
Ethernet	24
Network Installation Plan	25
Installation Overview	25
Plan the Physical Installation	26
Sources of Interference	27
Hardware Installation	28
Antennas	28
Antenna Selection	28
Antenna Electrical Characteristics Overview	28
Antenna Pattern	28
Antenna Gain	28
Antenna Polarity	29
Antenna Types	30
Antenna Types Overview	30
Whip Antennas	30
Collinear Array Antenna	31
Yagi Array Antenna	32
Parabolic Reflector Antenna	33
Approved Antennas	34
Antenna Spacing Requirements	35
Max Antenna Gain / Output Power	35
Antenna Installation	36
Antenna Installation Overview	36
Connecting Antennas	36
Master Antenna	36
Repeater Antennas - Single or Dual	37
Remote Antennas - Antenna Diversity	38
Antenna Location, Spacing, and Mounting	39
Ethernet Radio	40
Cable Specifications: Cross-Over or Straight-Thru	40

RadioLinx Setup/Diagnostic Software	41
Serial Port Settings	41
Viewing the Serial Port Settings	41
Setting the Serial Port.....	42
Serial Port Factory Defaults Illustrated.....	43
Ethernet Port Settings.....	45
Ethernet Start	45
Ethernet Addressing Overview.....	46
Setting The IP Address of the Host Computer	47
Setting the Ethernet Port	50
Network Configuration	51
Select Radio Color.....	51
Define Network Name, Type, Channel.....	54
Invalid Encryption Key.....	56
Password Invalid	56
Password Confirm	57
Password Mismatch	57
Graphical Layout Screen.....	59
Adding Remote Radios to a Network	60
Adding Repeaters to a Network	61
Graphically Define the RF Link.....	63
Auto Layout of Network Icons	64
Rename Radios.....	65
Change a Radio's Type	67
Delete a Radio.....	68
Save the Network's Definition.....	70
Printer Settings	72
Print the Network's Configuration	74
Radio Configuration	75
General Radio Configuration	75
Radio Configuration - Protocol Transparent.....	77
Radio Configuration - Modbus & DNP Protocol	79
Radio Configuration - Ethernet.....	83
Save the Radio's Configuration	85
When to Re-Configure Radios	86
Existing Network Maintenance.....	87
Modify Network Settings.....	87
Assigning Device IDs Network Wide	89
Modify Radio Settings.....	91
Change a Network's Properties.....	92
Miscellaneous Options.....	94
Zoom View of Graphical Layout	94
Zoom In.....	94
Zoom Out.....	96
Super Zoom	97
Zoom To Fit	99
Upgrade Software - Download Code.....	100
Diagnostics.....	102
Diagnostics Overview	102
View Operating Network.....	102
Viewing Signal Strength	104
Broken Links in a Radio Network	106
Query a Radio Directly	107
Query a Radio Remotely	110
Test the Network Installation Plan.....	113
Troubleshooting.....	114
Troubleshooting Overview	114

Automatic Serial Port Check	114
Cannot Configure a Radio	114
Radios do not communicate	116
Contact the Manufacturer	119
Reference Information	120
Serial Port Basics	120
Glossary	122

Product Overview

Summary of Function and Use

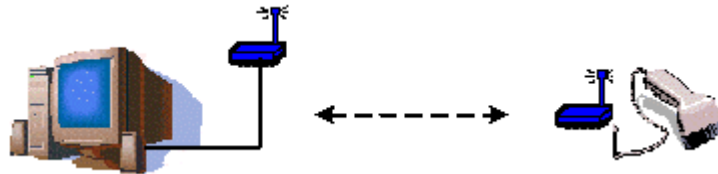

RadioLinx wireless modems and switches provide a wireless replacement for serial or Ethernet cables. Any two devices that could otherwise function together with a physical serial/ethernet cable between them can be incorporated into a wireless network. A wireless radio link can be used in any situation where a Master device and its Remote device are located such that a serial/ethernet cable connection between them is impractical or impossible.

The RadioLinx wireless modems and switches transmit using the "frequency hopping spread spectrum" communication technique:

- **Frequency hopping:** A radio which continuously changes its operating frequency several times per second following a pre-determined sequence of frequencies is defined as "frequency hopping". The transmitting and receiving radios are programmed to follow the same frequency hopping sequence.
- **Spread spectrum:** Spread spectrum refers to spreading a narrow-band signal over a much broader frequency band than required.

The RadioLinx design takes advantage of the following characteristics inherent to the spread spectrum technique:

- **increased immunity to interference.** RadioLinx wireless modems and switches are designed to detect specific radio frequencies. An "interferer" is defined as an unwanted signal that has been transmitted at the same frequency that the radio was designed to detect. There are many man-made and natural sources of electromagnetic interference. Due to the frequency hopping spread spectrum technique, the RadioLinx wireless modem and switches operate more reliably than a radio using conventional technology.
- **multiple users** can share the same frequency band at the same time. For example, cell phone use depends on spread spectrum signal transmission.

Regulatory Approvals

FCC Part 15 & Industry Canada Rules

The statements contained in this "Regulatory Approvals" section are required. If the Prosoft Technology, RadioLinx wireless modem and switches are used as a component of any device, these statements must be a component of that device's product documentation.

COMPLIANCE STATEMENT

The Prosoft Technology, RadioLinx devices comply with Part 15 of the FCC Rules as well as Industry Canada Rules. Operation is subject to the following two conditions:

- this device may not cause harmful interference, and,
- this device must accept any interference received, including interference that may cause undesired operation.

NOTE:

The Prosoft Technology, RadioLinx module is labeled with an FCC ID number and a Canadian Certification Number. If this label is not visible when installed in an end-device, the outside of the device **MUST** also display a label referring to the enclosed RadioLinx. Use wording on the label similar to the following:

"Transmitter Module FCC ID: OQ7OS2400, Canada 36561031989A"

OR

"This device contains Transmitter Module FCC ID: OQ7OS2400, Canada 36561031989A."

WARNING

Changes or modifications to this radio module not expressly approved by its manufacturer, ProSoft Technology, may void the user's authority to operate the equipment.

CSA C22.2 213-M13987 & cUL Standard 1604 Listing

In accordance with Canadian Standard CSA C22.2 213-M1987, the RL-2400S and RL-2400E ONLY have been cUL Listed for operation under the Class I, Division 2, Groups A, B, C and D or Non-Hazardous Locations Only in accordance with cUL Standard 1604. The following statements pertain to the cUL warning to be in compliance with cUL standard 1604.

THIS EQUIPMENT IS SUITABLE FOR USE IN CLASS I, DIVISION 2, GROUPS A, B, C AND D OR NON-HAZARDOUS LOCATIONS ONLY.

WARNING

EXPLOSION HAZARD!

SUBSTITUTION OF COMPONENTS MAY IMPAIR SUITABILITY FOR CLASS I, DIVISION 2.

WARNING

EXPLOSION HAZARD!

DO NOT DISCONNECT EQUIPMENT UNLESS POWER HAS BEEN SWITCHED OFF OR THE AREA IS KNOWN TO BE NON-HAZARDOUS.

The following is the label that is applied to the RL-2400S radio modem ONLY to indicate the unit is listed under the cUL standard 1604.



Class 1 Division 2
Groups A, B, C & D
Max. Ambient: 70°C

10-24 Volts DC
10 Watts
Temp. Code: T4A

NOTE: The Temp. Code (Temperature Code) refers to the temperature of the rating of the RL-2400S. T4A means this unit measured less than or equal to 120 degrees Celsius.

The following is the label that is applied to the RL-2400E modem *ONLY* to indicate the unit is listed under the cUL standard 1604.



Class 1 Division 2	10-24 Volts DC
Groups A, B, C & D	10 Watts
Max. Ambient: 70°C	Temp. Code: T4A

NOTE: The Temp. Code (Temperature Code) refers to the temperature of the rating of the RL-2400E. T4A means this unit measured less than or equal to 120 degrees Celsius.

European CE Certification

The RL-2400S modems have been approved for operation under the RTT&E directive passing the following tests:

ETS300-826	EMC
ETS300-328	Functionality
EN60950	Safety

The following is the appropriate label that is applied to the RadioLinx product line to indicate the unit is approved to operate with CE certification:

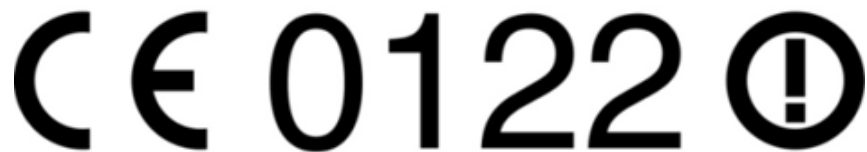

The following is the appropriate label that is applied to the RadioLinx product line shipping package to indicate the unit is approved to operate with CE certification:

AUS	B	DK	FI N
£	D	GR	IR E
I	LUX	NL	P
E	S	UK	

Note: -member states in the EU with restrictive use for this device are crossed out !

-This device is also authorized for use in all EFTA member states (CH, ICE, LI, NOR)



Important Notice:

This device is a 2.4 GHz low power RF device intended for office and home use in all EU and EFTA member states except in France where restrictive use

applies.

Antenna Spacing Requirements - User Safety

It is important to keep the radio's antenna a safe distance from the user. In order to meet the requirements of FCC part 2.1091 for radio frequency radiation exposure, this module must be used in such a way as to guarantee at least 20cm (or more for high gain antennas- see antenna chart) between the antenna and the body. The FCC requires a minimum distance of $1\text{mW} \cdot \text{cm}^2$ squared power density from the user (or 20cm, whichever is the greater distance).

If a specific application requires proximity of less than 20cm, the application must be approved through the FCC for compliance to part 2.1093.

The installer of this radio equipment must ensure that the antenna is located or pointed such that it does not emit RF field in excess of Health Canada limits for the general population; consult Safety Code 6, obtainable from Health Canada.

To reduce potential radio interference to other users, the antenna type and its gain should be so chosen that the equivalent isotropically radiated power (EIRP) is not more than that required for successful communication.

Getting Started

System Overview



These are the main steps used to configure a new RadioLinx wireless radio network:

- Plan the network (including physical installation and hardware installation)
- Identify the appropriate network type
 - Protocol Transparent Point-to-Point
 - Protocol Transparent Broadcast
 - Modbus RTU
 - Modbus ASCII
 - DNP
 - RadioLinx OEM Protocol
 - Dialup Modem Emulation
 - Ethernet
- **Identify** and set the Configuration PC's serial port
- Configure the network
- Configure the radios
- Install the antennas and radios - test the network's installation.
- Use software Diagnostics, if necessary, to view a graphical representation of the operating network, and **query** or **display** the operating parameters of individual radios,
- Troubleshoot network problems, if necessary, or contact the manufacturer

The Setup / Diagnostic Software

The RadioLinx Setup Application provides a user interface for the configuration and maintenance of a radio network. It graphically reflects the **physical** layout of the component radios.

The Setup Application provides a means to:

- **configure** new networks and radios:
 - assign roles (Master, Remote or Repeater) to the radios.
 - define data paths
 - set the radio's operation parameters (baud rate, parity, IP Address etc.)
- **edit** existing networks or radios:
 - add or delete Remote or Repeater radios
 - re-assign roles to the radios.
 - define operation parameters
- **diagnose** functionality of existing networks.
 - display the status of each REMOTE or REPEATER radio (when a MASTER radio is cabled to the PC)

NOTE:

Prosoft Technology, recommends that the RadioLinx Setup Application be installed on **only one computer** and that the network configuration be done **only from that one computer**. When a **network is designed**, configuration settings are stored in a database in the RadioLinx Setup Application. **When networks are modified**, the RadioLinx Setup Application depends upon the retrieval of the network's configuration history. Network modification and maintenance is easier if the RadioLinx Application Software is installed on only one computer. All subsequent network-related configurations are done using that one computer.

The computer where the RadioLinx Setup Application has been installed will be referred to as the Configuration PC throughout these Help files.

Functional Conventions

The **Ok**, **Cancel**, **Close**, and **Exit** functions are available from many of the RadioLinX Setup/Diagnostic Application screens. These functions cause the same action from any screen, providing a consistent function throughout the application:

- **Ok** to confirm/enter any changes made and return to the application's main screen.
- **Cancel** to discard any changes and return to the application's main screen.
- **Close** the current screen and return to the application's main screen:

Main Menu

- ▶ **Menu Bar Radio icon (far left of the Menu Bar)**
- ▶ **Close**

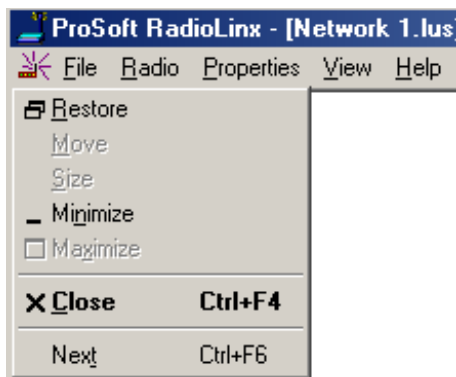

OR

(Any of the RadioLinX's Setup/Diagnostic Application screens):

- ▶ **File**
- ▶ **Close**

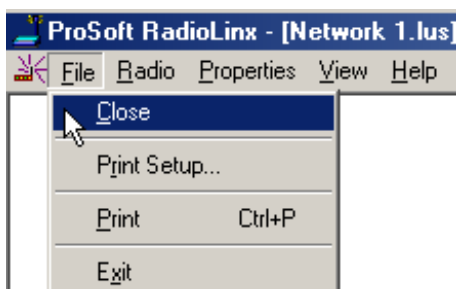

- **Exit** the application completely, select:

(Any of the RadioLinx's Setup/Diagnostic Application screens):

- ▶ **File**
- ▶ **Exit**

From the **Main Screen**:

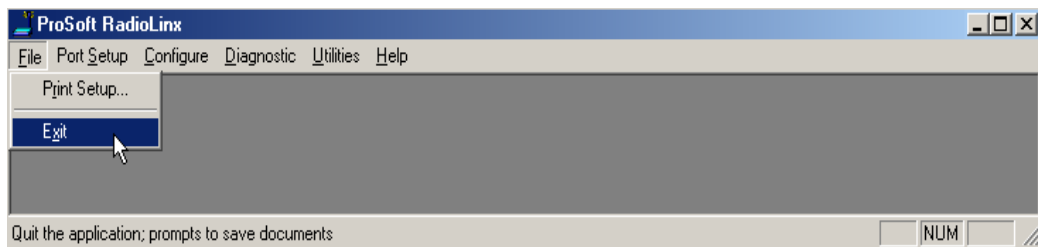

From either the **Configuration** or the **Diagnostics** screens:

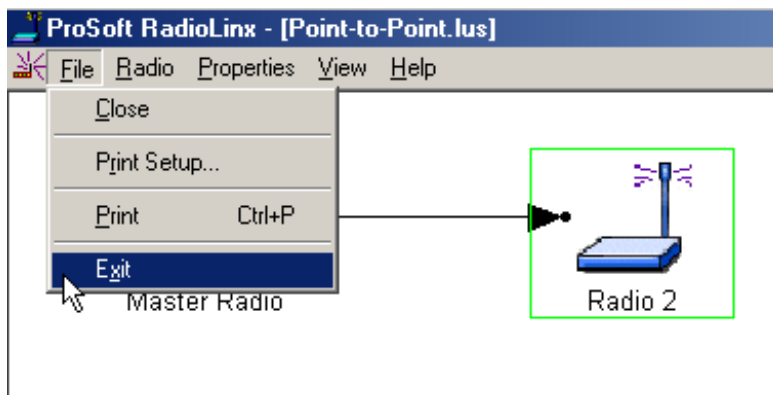

Radio Networks

Radio Network Defined

A radio network provides wireless replacements for serial or Ethernet cables. Any two devices which could otherwise function together with a physical serial cable between them can be incorporated into a wireless network and continue to function normally. A basic network consists of a Master radio cabled to one device and a Remote radio cabled to another device.

As examples, Master device - Remote device pairs could be:

- computer - printer
- computer - scanner
- scanner - printer
- Modbus controller - industrial tool

A radio link can be used in any situation where a Master device and its Remote device are located such that a **serial or Ethernet cable connection** between them is **impractical** or **impossible**. The radios can communicate up to 15 miles depending upon site selection (terrain, antenna type, environmental noise, etc.) and other sources of interference.

An example of a basic radio network is illustrated below. In this example, the Master device is a **computer** and its Remote device is a **hand-held scanner**.

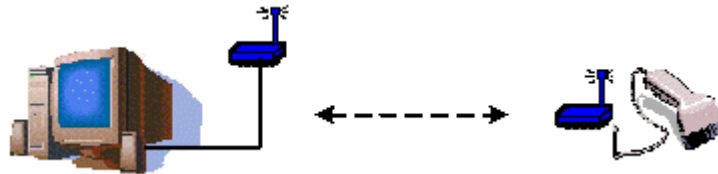

Network Types

Network Types

There are seven network types:

- **Protocol Transparent Point-to-Point**
- **Protocol Transparent Broadcast**
- **Modbus RTU**
- **Modbus ASCII**
- **DNP**
- **RadioLinx OEM Protocol**
- **Dialup Modem Emulation**
- **Ethernet**

NOTE:

There is only one Master radio for each network.

Protocol Transparent Network

Protocol Transparent networks configure the RadioLinx radios to pass data independent of the protocol in the data being sent. A Protocol Transparent network can be created in one of two configurations, **Point-to-Point** and **Point-Multipoint Broadcast**.

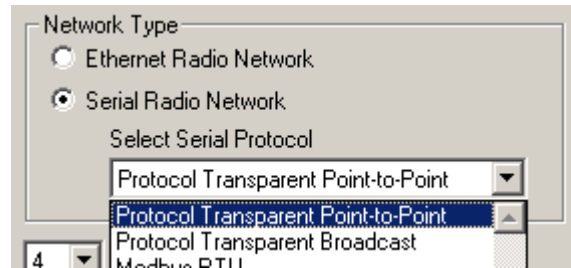

- **Point-to-Point** configuration transfers data between two radios (points) in the network. In the network shown below, the Master Radio and Radio 2 transfer data between each other. Radio 3 only acts as a bridge to get the data between them.

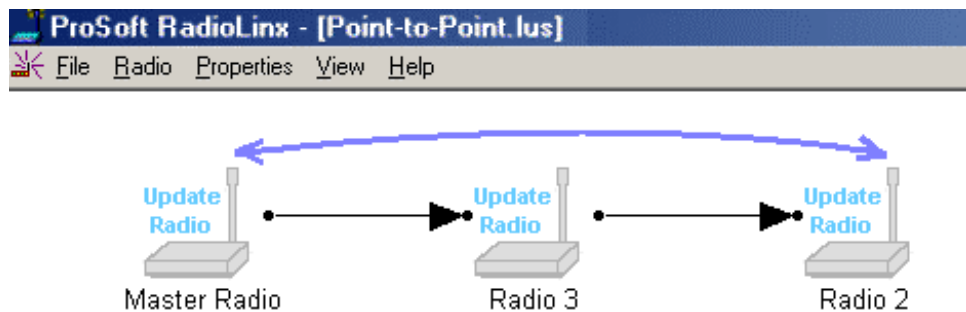

- **Broadcast** configuration creates the network to broadcast data from the Master radio to the other radios in the network. All of the other radios return their data to the Master radio.

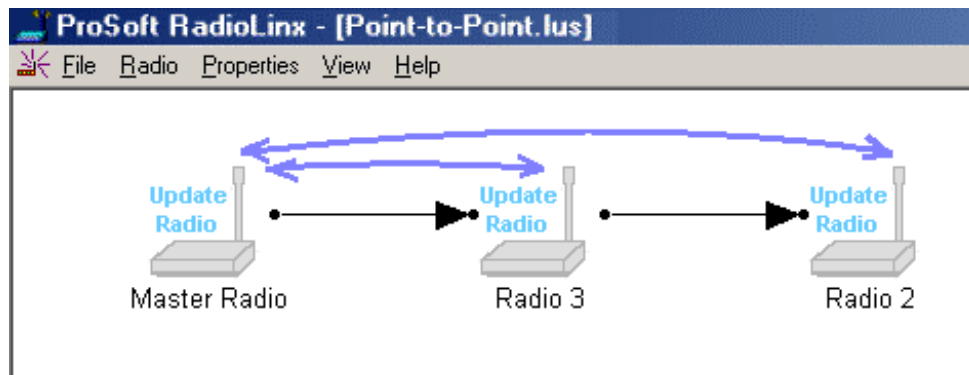

After the network has been created, the settings in the radios can be modified to allow data from one radio to be passed to any other or all other radios in the network. The figure below shows the possible settings for Radio 2.

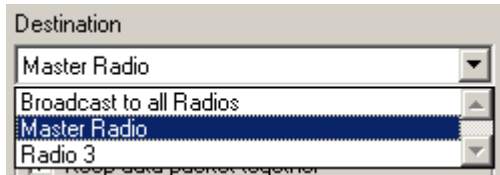

For example, peer-to-peer communication can be established in a Protocol Transparent network by setting the destination in each of the radios to 'Broadcast to all Radios'.

Several networks can operate at the same location, however, each network **must use a different network channel**.

NOTE:

Each point-to-point network operates independently of each other - there can be **no intercommunication** between point-to-point networks.

Modbus RTU & Modbus ASCII

A **Modbus** network is a network with a single Master radio and multiple Remote radios. The RadioLinx Point-Multipoint Modbus networks can only be used with devices that are designed to use the Modbus RTU (Remote Terminal Unit) or ASCII communication modes. Each device has its own Modbus address in a Modbus network and each radio's address must be correlated with the Modbus address of the device cabled to it during the network configuration process. In a Point-Multipoint (Modbus) network, the **destination** must be determined and the **address information** must be resolved before the transmission can proceed.

Devices cabled to radios communicate using the Modbus standard protocol. The Master radio sends data to a Remote radio based on the Modbus address of the Modbus device. Data is only sent to the single Remote device if it has the right address. Each Remote radio sends its data only to the Master radio. The Master and Remote radios acknowledge that data was received correctly.

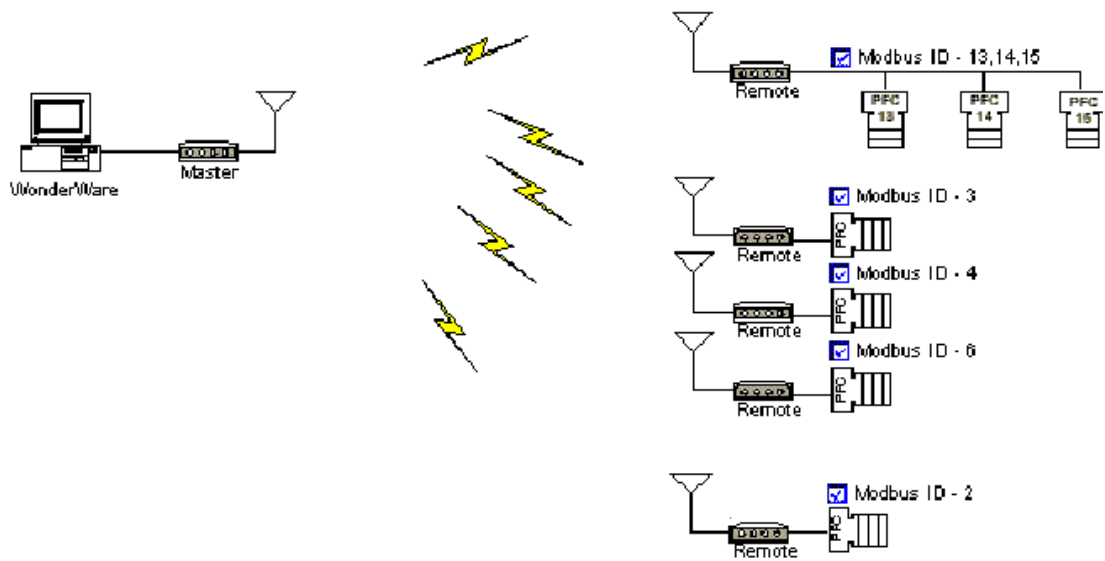

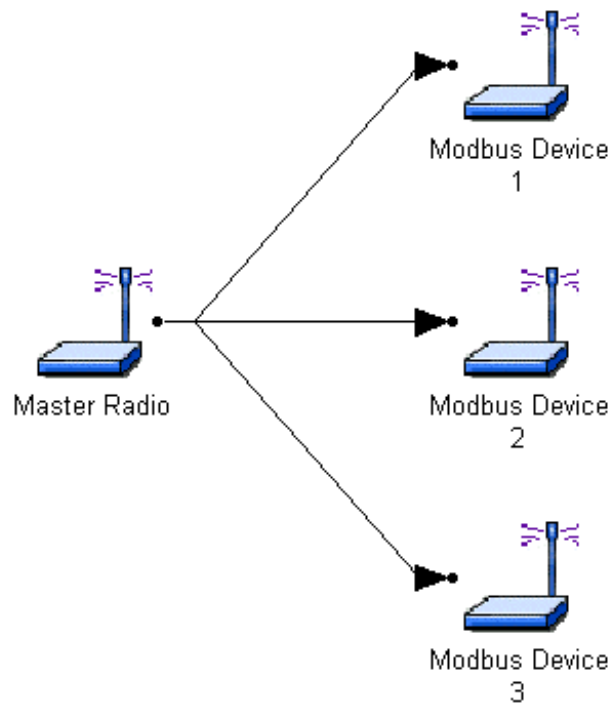

RadioLinx OEM Protocol Network

The RadioLinx OEM Protocol Network type configures radios in the network to communicate via the RadioLinx OEM Protocol.

The RadioLinx OEM Protocol is typically used by manufacturers that integrate the RadioLinx wireless modems or switches into their products. Any manufacturer can add wireless capability to their product by simply integrating the compact radio into their device.

This Protocol, defined by ProSoft Technology, provides a data format that will allow any device to perform peer-to-peer communications over the radio network.

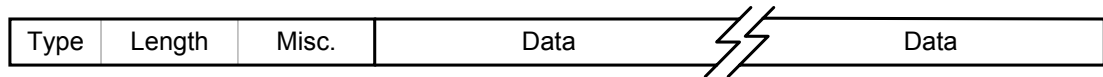

By adhering to the OEM protocol devices can communicate with other devices as well as perform diagnostics of the radio network.



DNP Protocol



DNP is a protocol for communication between industrial devices, often used in utilities such as power distribution.

The DNP radio network type configures the radios to support communications between DNP devices over the radio network. The software configures each radio with a table of the DNP's device IDs and the radios they are attached to. This allows the radios to direct DNP packets through the network to the correct destination.

Although the structure of the radio network consists of a Master radio and connecting Repeaters and Remotes, the radios can all communicate with each other, allowing peer-to-peer communication among the DNP devices.

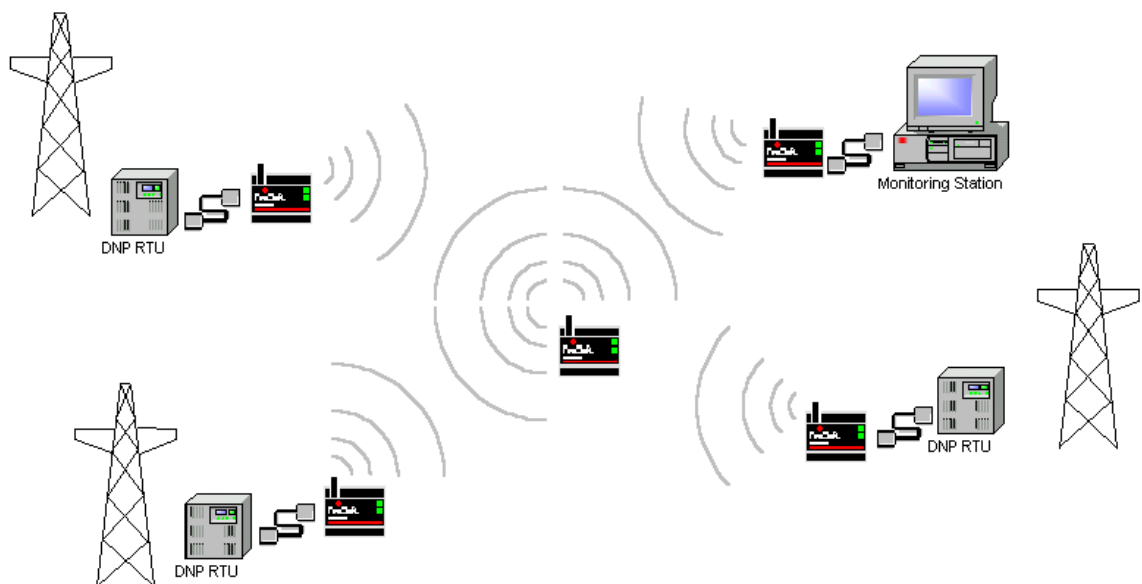

Dialup Modem Emulation Network

The Dialup Modem Emulation Network Type configures the radios in the network to emulate telephone dial-up modems. Devices that would normally communicate with a host computer through a leased-line modem can now communicate through the radio network, avoiding the cost of leased lines.

The device "dials" another radio in the network using the standard Hayes modem AT command set. The radio indicates to the device that a connection has been made. The device can then begin transferring data as if it were communicating over a modem.

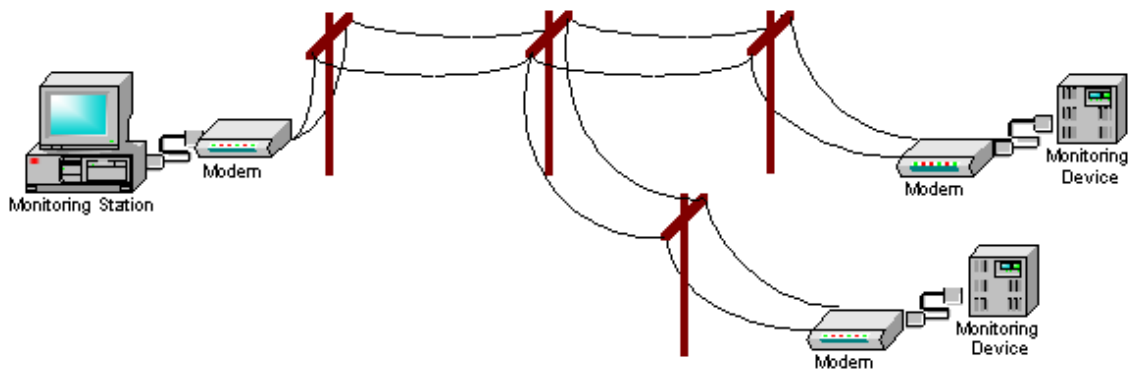

SCADA System using leased-line modems for communication



SCADA System using RadioLinx radio network for communication

Ethernet

RadioLinx wireless Ethernet switches provide a wireless replacement for an Ethernet network connection. Any two Ethernet devices that could otherwise function together with a physical cable between them can be incorporated into a wireless network.

An Ethernet wireless network allows two or more computers to communicate and share data stored on each computer without having the traditional Ethernet cabling between them. As an example, one Master radio is connected to an Ethernet device and a Remote radio is connected to another Ethernet device. (The Master and Remote radios may or may not communicate through Repeater radios.) The devices that can be connected include Ethernet hubs and switches.

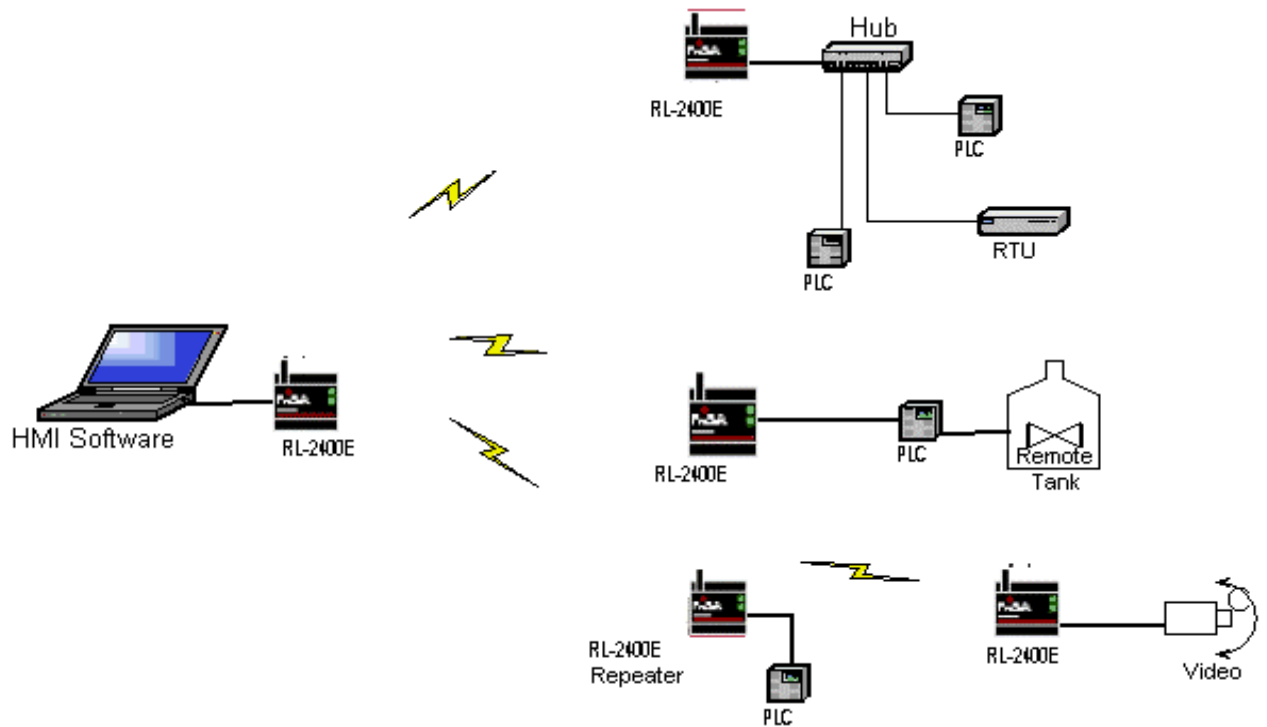

Network Installation Plan

Installation Overview

Create an installation plan that includes the following elements:

- **Physical Installation**
 - Plan the physical installation
 - Account for sources of interference
- **Hardware Installation**
 - Antennas
 - Antenna Electrical Characteristics
 - Antenna Types
 - Approved Antennas
 - Antenna Spacing Requirements – User Safety
 - Antenna Installation
- **Radios**
 - Radio Power Requirements
- **Communication Hardware**
 - Cable Specifications for Ethernet connection

Plan the Physical Installation

A network's performance is impacted by attributes specific to the installation site. Take the following into consideration, where possible, to maximize network installation:

- protect radios from direct exposure to weather
- provide an adequate and stable power source to the radios
- design the network to use less than 2048 radios (per network)
- place radios within the specified 15 miles of each other
- add repeater to extend distance or where line of sight is limited
- radios or antennas CANNOT be placed within 20 cm of where people will be

Though radio frequency communication is reliable, sometimes its performance can be impacted by intangibles. A good network installation plan includes **time** and **resources** for performance testing and installation changes.

Test the installation plan before the network installation is complete.

Sources of Interference

RadioLinx wireless modems and switches operate more reliably than a radio using conventional technology due to the frequency hopping spread spectrum technique. While RadioLinx radios are less susceptible to interference due to this technique, interference (radio "noise") may still occur. Radios are designed to detect specific radio frequencies. An "interferer" is an unwanted signal that has been transmitted at the same frequency that the radio was designed to detect.

There are many man-made and natural sources of electromagnetic interference (lightning, power lines, switching power supplies, fluorescent lighting, microwave ovens, cordless phones, etc.). To decrease the effects of interference on network function:

- use a directional (high gain) antenna at the Remote radio locations, if possible
- verify that each network operating in close proximity to each other has BEEN ASSIGNED TO A DIFFERENT CHANNEL
- install networks in rural areas (if at all possible) where they will likely encounter less man-made noise than in urban or suburban areas
- enable encryption
- change a radio's network output power (see the Radio Settings - Transmit Power sections in the Radio Configuration screens for each type of network):
 - **increase** power to "drown out" competing noise
 - **decrease** power of the radios on the network if they are interfering with another network in the vicinity

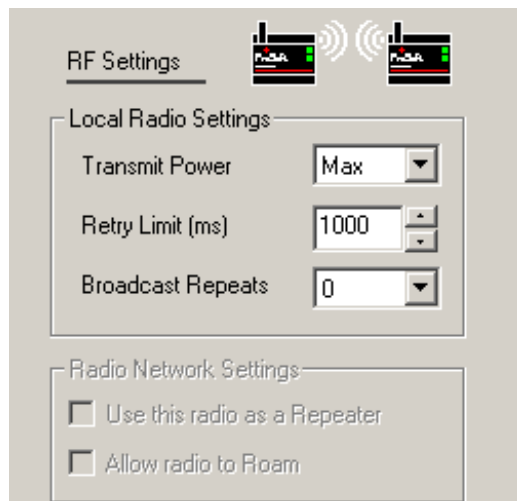

Transmit Power drop-down button for all networks

Hardware Installation

Antennas

Antenna Selection

Antenna Electrical Characteristics Overview

There are three important electrical characteristics to consider when selecting antennas:

- **Antenna Pattern**
- **Antenna Gain**
- **Antenna Polarity**

Antenna Pattern

Information between two radios is transferred via electromagnetic energy radiated by one antenna and received by the second. More power is radiated in certain directions away from an antenna than others. A plot of **the intensity of this radiated power** versus **the direction from the antenna** is called **the antenna pattern**. Each antenna should be mounted so that the direction of strong radiation intensity points towards the other antenna or antennas to which it is to establish communication ("link").

Complete antenna patterns are three-dimensional. A two-dimensional slice of the pattern is often shown; this is useful because often all the antennas of interest are located horizontally from one another along the ground rather than above or below each other.

A slice taken in a horizontal plane through the center (or looking down on the pattern) is called the **azimuth pattern**. Looking from the side, a vertical plane slice is seen; this is called the **elevation pattern**.

An antenna pattern that has equal or nearly equal intensity in all directions is **omni-directional**. In two dimensions, an omni-directional pattern is a **circle**. An antenna is considered omni-directional if one of its two-dimensional patterns is omni-directional. (In three dimensions, an omni-directional pattern would be a sphere, but no antenna has an omni-directional pattern in three dimensions.)

Beam width is an angular measurement of how strongly the power is concentrated in a particular direction. Beam width is a three-dimensional quantity but can be broken into two-dimensional slices just like the antenna pattern. The beam width of an omni-directional pattern is 360° since the power is equal in all directions.

Antenna Gain

Antenna gain is a measure of how strongly an antenna radiates in its direction of maximum radiation intensity compared to how strong the radiation would be if the same power were applied to an antenna that radiated all of its power equally in all directions. Using the antenna pattern, the gain is the distance to the furthest point on the pattern from the origin. For an omni-directional pattern, the gain is 1, or equivalently 0dB. The higher the antenna gain, the narrower the beam width, and vice versa.

The amount of power which is received by the receiving antenna is proportional to the transmitter power multiplied by the transmit antenna gain, multiplied by the receive antenna gain. Therefore, the antenna gains and transmit power can be traded off. For example, doubling one antenna gain has the same effect as doubling the transmitter power. Doubling **both** antenna gains has the same effect as quadrupling the transmit power.

Antenna Polarity

Antenna polarization refers to the direction that the electromagnetic field lines point as energy radiates away from the antenna. In general, the polarization is **elliptical**. The simplest and most common form of this elliptical polarization is simply a straight line, or **linear polarization**. Of the transmitted power that reaches the receiving antenna, only the portion that has the same polarization as the receiving antenna polarization is actually received. For example, if the transmit antenna polarization is linear pointed in the vertical direction (vertical polarization, for short), and the receive antenna also has vertical polarization, the maximum amount of power possible will be received. On the other hand, if the transmit antenna has vertical polarization and the receive antenna has horizontal polarization, theoretically, **no** power should be received. If the two antennas have linear polarizations orientated at 45° to each other, half of the possible maximum power will be received.

Antenna Types

Antenna Types Overview

The following antennas are approved for use with RadioLinx wireless modems and switches:

- **whip antenna**
- **collinear antenna**
- **yagi array antenna**
- **parabolic reflector antenna**

Whip Antennas

Use one of the types of whip antennas approved for use with the RadioLinx wireless modems and switches.

$1/2\lambda$ Straight Whip or $1/2\lambda$ Articulating Whip (2dBi)

- Most commonly used antenna
- Length approximately 5 inches
- Likely to be connected to a remote radio (connected directly to the radio enclosure)
- Does not require a ground plane

The function of articulating antennas is the same as non-articulating antennas. An articulating antenna bends at the connection (as shown).



$1/4\lambda$ Whip Antenna (2dBi)

- Shorter than the $1/2\lambda$ whip (2.5")
- Requires a ground plane mounted below the antenna and over the top surface of the radio
- Needs to remain vertical (does not radiate well out the top of antenna)
- Works well for belt-mounted remote radios

Refer to the Antenna Types overview section for other types of approved antennas.

Collinear Array Antenna

A collinear array antenna is typically composed of several linear antennas (like the $\frac{1}{2}$ wave whip) stacked on top of each other. The more stacked elements it has, the longer it is, and the more gain it has. It is fed in on one end.

The antenna pattern is torroidal; its azimuthal beam width is 360° (omni-directional); its vertical beam width depends on the number of elements/length (where more elements equals narrower beam width).

The antenna gain depends on the number of elements/length (where more elements produces higher gain). Typical gain is 5-10dBi.

The antenna polarity is Linear (parallel to the length of the antenna).



Refer to the Antenna Types overview section for other types of approved antennas.

Yagi Array Antenna

A yagi antenna is composed of an array of linear elements, each parallel to one another and attached perpendicular to and along the length of a metal boom. The feed is attached to only one of the elements. Elements on one side of the fed element are longer and act as reflectors; elements on the other side are shorter and act as directors. This causes the antenna to radiate in a beam out of the end with the shorter elements. The pattern depends on the overall geometry, including the number of elements, element spacing, element length, etc. Sometimes the antenna is enclosed in a protective tube hiding the actual antenna geometry.

The antenna pattern is a beam pointed along the boom toward the end with the shorter elements. The beam width varies with antenna geometry but generally is proportional to the length (where longer length produces a narrower beam).

The antenna gain varies with antenna geometry but generally is proportional to the length (where longer length produces higher gain). Typical values are 6 to 15dBi.

The antenna polarity is Linear (parallel to the elements, perpendicular to the boom).



Refer to the Antenna Types overview section for other types of approved antennas.

Parabolic Reflector Antenna

A parabolic reflector antenna consists of a parabolic shaped dish and a feed antenna located in front of the dish. Power is radiated from the feed antenna toward the reflector. Due to the parabolic shape, the reflector concentrates the radiation into a narrow pattern (resulting in a high gain beam).

The antenna pattern is a beam pointed away from the concave side of the dish (beam width varies with the size of the reflector and the antenna construction).

The antenna gain varies with the size of the reflector and the antenna construction. Typical values are 15 to 30dBi.

The antenna polarity depends on the feed antenna polarization.



Refer to the Antenna Types overview section for other types of approved antennas.

Approved Antennas

Only antennas specifically approved by the U.S. Federal Communications Commission (FCC) and Industry Canada for use with the RadioLinx wireless modems and switches are allowed. At the time of this printing, the antennas listed below were the **only antennas approved for use with RadioLinx wireless modems and switches**. Contact ProSoft Technology. for approval of other antennas.

Antennas with 12dB gain and below are acceptable for Point-to-Point, Point-Multipoint and Ethernet networks. Antennas with over 12dB gain can **only** be used for Point-to-Point networks; they **cannot** be used for Point-Multipoint or Ethernet networks.

Point-to-Point and Point-Multipoint Networks

Type	Pattern	Gain	Polarization	Connector	Size (cm)	Minimum Distance from Body
½ Wave	Omni, Broadside	2dB	Linear	SMA-rp	7H x 1.5Ø	20cm (8in)
½ Wave, articulating	Omni, Broadside	2dB	Linear	SMA-rp	10H x 1.0Ø	20cm (8in)
Collinear Array	Omni, Broadside	5dB	Linear	SMA-rp	19H x 1.0Ø	20cm (8in)
Collinear Array	Omni, Broadside	8dB	Linear	N-rp	43H x 1.6Ø	20cm (8in)

Point-to-Point networks only

Type	Pattern	Gain	Polarization	Connector	Size (cm)	Minimum Distance from Body
Yagi	Beam, Endfire	15dB	Linear	N-rp	81L x 9.0Ø	20cm (8in)
Parabolic	Beam, Broadside	24dB	Linear	N-rp	71H x 86W x 29D	50cm (20in)

Antenna Spacing Requirements

Max Antenna Gain / Output Power

NOTE:

FCC rules limit the antenna gain to 12dBi for point-multipoint networks using the RadioLinx wireless modems and switches. All of the antennas approved for operation may be used for Point-to-Point applications as they fall within the 24dB limit, however, antennas with gain greater than 12dBi noted in the Approved Antennas table cannot be used for Point-Multipoint networks (broadcast, Modbus or Ethernet). The calculations listed below illustrate these limitations.

The FCC transmitter power limit for this type of radio is 30dBm (or 1 watt). In addition, safety considerations limit the output of this module to 250mW. To meet the FCC requirements for emissions, the following restrictions on antenna gain **must** be observed when establishing a radio network:

Point-to-Point network:

max power 250mW / max antenna gain 24dBi

- The transmitter power reference for a Point-to-Point network is 30dBm (1 watt) of output power with an antenna gain of 6dBi. For each 1dB decrease in output power below this reference point, the antenna gain can increase by 3dB.
- With the RadioLinx radio module's maximum output power of 250mW, the maximum allowable antenna gain is 24dBi in a Point-to-Point application.

$$6\text{dBi} + (30\text{dBm} - 24\text{dBm}) * 3 = 24\text{dBi}$$

Point-Multipoint and Ethernet networks (Broadcast, Modbus and Ethernet):

max power 250mW / max antenna gain 12dBi

- The transmitter power reference for a Point-Multipoint (Broadcast) network is 30dBm (1 watt) of output power with a maximum antenna gain of 6dBi.
- For each 1dB decrease of output power below this reference point, the antenna gain can increase by 1dB.

RadioLinx modules have a maximum output power of 250mW or 24dBm. Therefore, the maximum allowable antenna gain at full output power is 12dBi in a Point-Multipoint (Broadcast) application.

$$(30\text{dBm} - 24\text{dBm}) * 1 = 12\text{dBi}$$

Antenna Installation

Antenna Installation Overview

Read the information in the following sections when installing antennas for maximized antenna performance:

- **connecting antennas**
- **antenna diversity**
- **antenna location, spacing, and mounting**

Connecting Antennas

Each wireless modem or switch must have an antenna connected to the primary antenna port (port A); without an antenna for each radio, the network will not function. Remote and Repeater radios may have a second antenna attached to port B.

All antennas for wireless modems or switches communicating directly with each other should be mounted so they have the same antenna polarity.

Small antennas with a reverse polarity sma connector can be mounted directly on the radio. Simply screw the antenna onto the antenna port connector until snug.

Larger antennas and antennas that don't have a reverse gender SMA connector must be mounted separately and connected to the radio using a coaxial antenna cable. Since the antenna cable attenuates the RF signal, **use an antenna cable length no longer than necessary to ensure optimum performance.**

For more information when connecting antennas to each type of radio go to:

- Master Antenna
- Remote Antennas – Antenna Diversity
- Repeater Antennas – Single or Dual

NOTE:

It is illegal to use any antenna that is not on the ProSoft Technology approved antennas list. Contact the manufacturer with any questions or browse the antenna FAQ at the company website.

Refer to the Antenna Installation Overview section for more installation topics.

Master Antenna

The Master radio used a single antenna connected to port A.

Repeater Antennas - Single or Dual

Since a Repeater is often used to lengthen the distance a network can cover, it is often desired to use 2 directional antennas pointed in opposite directions to maximize that distance. However, it may be advantageous for some customers to use a single antenna (for lower cost when maximum distance is not the primary objective). A Repeater radio can be configured to use either,

- the same (single) antenna while transmitting forward and reverse
- dual antennas while transmitting forward and reverse

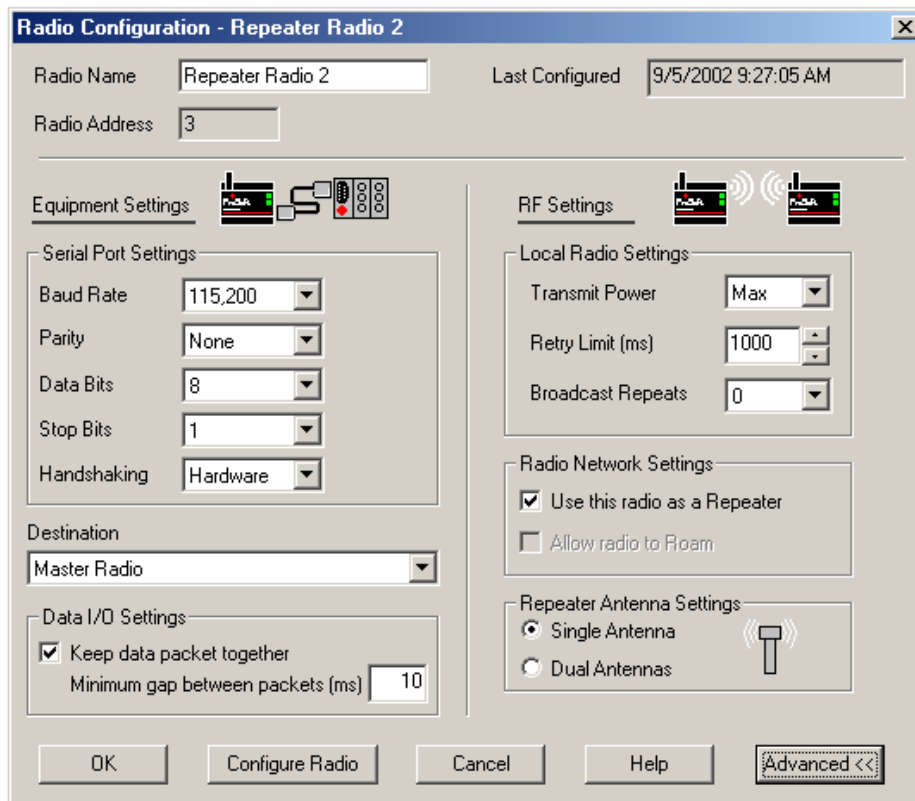
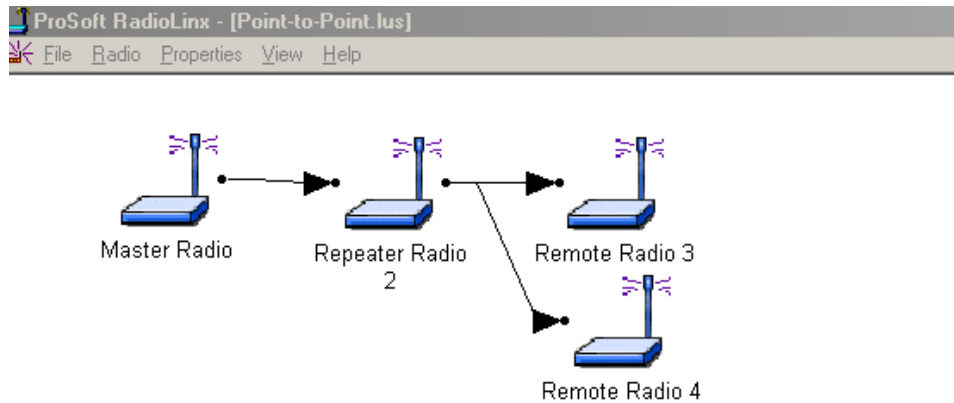

If using a single antenna, connect it to port A.

If using dual antennas, connect the forward antenna (away from the Master) to port A and the reverse antenna (toward the Master) to port B.

NOTE:

Make sure that directional antennas are able to "view" the other radios they need to communicate with.

Remote Antennas - Antenna Diversity

On Remote radios, antenna port B can be used to connect a second antenna to increase throughput when the radio is near the edge of its range or if there are many obstructions (such as inside a building). At first, only the primary antenna is used until a communications link is established with the master radio. After linking, the remote radios measure the signal strength at each antenna port for each frequency hop and select the port with the stronger signal at that frequency. Port A will always be used if no antenna is connected to port B. This technique is commonly referred to as **antenna diversity**. If one antenna happens to be at a location where there is a strong fade, it is unlikely that the second antenna at a different location will simultaneously be at a strong fade. Even several inches between the two antennas can be enough for this to help.

NOTE:

Antenna diversity does not work on the Master radio. It is primarily for the Remote radios. A Repeater radio will also use antenna diversity when communicating in the reverse direction if an antenna is connected to port B. – see Repeater Antennas and Connecting Antennas

Refer to the Antenna Installation Overview section for more installation topics.

Antenna Location, Spacing, and Mounting

Consider the following regarding antenna location, spacing, and mounting:

- when placing antennas, ensure a clear line-of-sight between the Master radio's antenna and all of the Remote radio antennas when placing the antennas if at all possible
- if the site base contains obstructing terrain or structures, mount the antenna on a tower or rooftop to provide a line-of-sight path. The line-of-sight consideration becomes more important as the transmission path becomes longer. It is **most** important as the transmission path approaches the limiting 15-mile distance specification.
- mount the antennas as high off the ground as practical (*the higher an antenna is above the ground, the greater its range*)
- mount the antennas away from massive structures (*radio signals bounce off metal walls, etc., compromising a clear signal*)
- mount the antennas in such a way as to minimize the amount of nearby metal structures in the antenna pattern
- mount the antennas and install radios away from sources of RF interference
- use the shortest antenna cable length possible (*signals lose power over cabled distance*)
- choose antennas appropriate for the network's intended function

Space antennas in multiple channel networks (more than one master radio) at least one meter apart so they don't overload each other. If antennas *must* be near each other:

- mount **omni-directional** antennas **directly above each other**
- position **directional** antennas so they don't point at nearby antennas
 - place antennas **side-by-side** if they point in the **same direction**
 - place antennas **back-to-back** if they point in **opposite directions**

Antenna network / polarity considerations:

- If antennas are on the same network, mount them so they have the same polarity
- If the antennas are on separate networks, mount them with a different antenna polarity (for example, one vertical and the other horizontal).

Refer to the Antenna Installation Overview section for more installation topics.

Ethernet Radio

Cable Specifications: Cross-Over or Straight-Thru

The recommended cable is category 5 or better. A category 5 cable consists of 4 twisted pairs of wire that are color-coded and can not be swapped. The Ethernet radio's switch uses two pair. One pair uses pins 1 and 2 and the second pair uses pins 3 and 6.

A Straight-Thru cable is used when connecting the wireless Ethernet switch to an Ethernet hub or a 10/100 Base T Ethernet switch.

A Cross-Over cable is used when connecting the Ethernet radio directly to any device that is NOT a switch or a hub (direct connection to a PC, PLC or printer).

Crossover Cable	
RJ-45 PIN	RJ-45 PIN
Connector 1	Connector 2
1 White/Orange	1 White/Green
2 Orange/White	2 Green/White
3 White/Green	3 White/Orange
4 Blue/White	4 Blue/White
5 White/Blue	5 White/Blue
6 Green/White	6 Orange/White
7 White/Brown	7 White/Brown
8 Brown/White	8 Brown/White

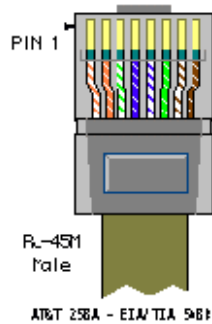

Straight Through Cable	
RJ-45 PIN	RJ-45 PIN
Connector 1	Connector 2
1 White/Orange	1 White/Orange
2 Orange/White	2 Orange/White
3 White/Green	3 White/Green
4 Blue/White	4 Blue/White
5 White/Blue	5 White/Blue
6 Green/White	6 Green/White
7 White/Brown	7 White/Brown
8 Brown/White	8 Brown/White

Note: The standard connector view shown is color-coded for a straight thru cable

RadioLinx Setup/Diagnostic Software

Serial Port Settings

Viewing the Serial Port Settings

Before radio communication can begin, the Configuration PC's serial port **must be identified** and its parameters **must be set**.

To view the current settings, from the main menu of the RadioLinx Setup Application's **Main Menu**, select:

- ▶ **Port Setup**
- ▶ **Serial Port Configure**

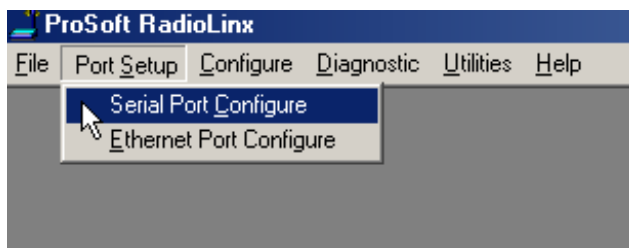

The displayed dialog box has three tabs. The serial port settings are displayed with the first of the tabbed dialog boxes, **Port**. See Setting the Serial Port to understand how to customize these settings.

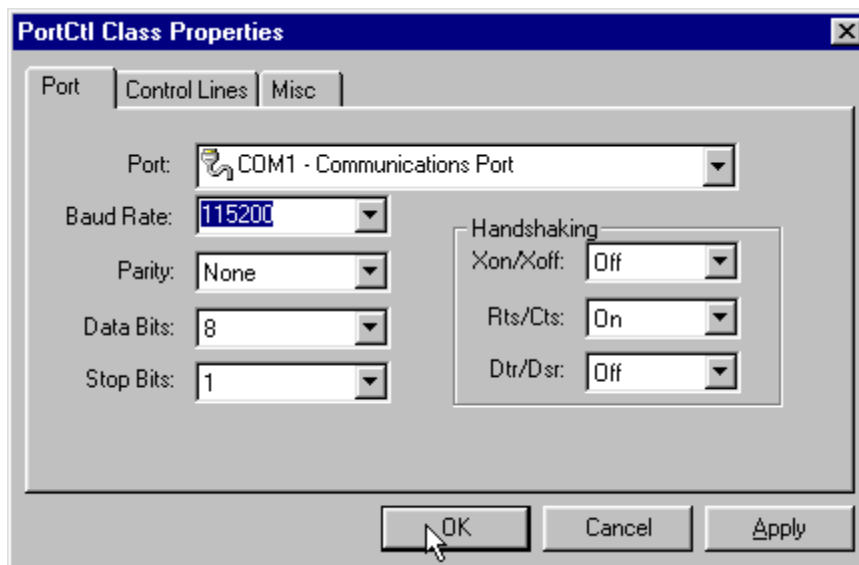

Setting the Serial Port

These are the factory-set serial port parameters for the Configuration PC:

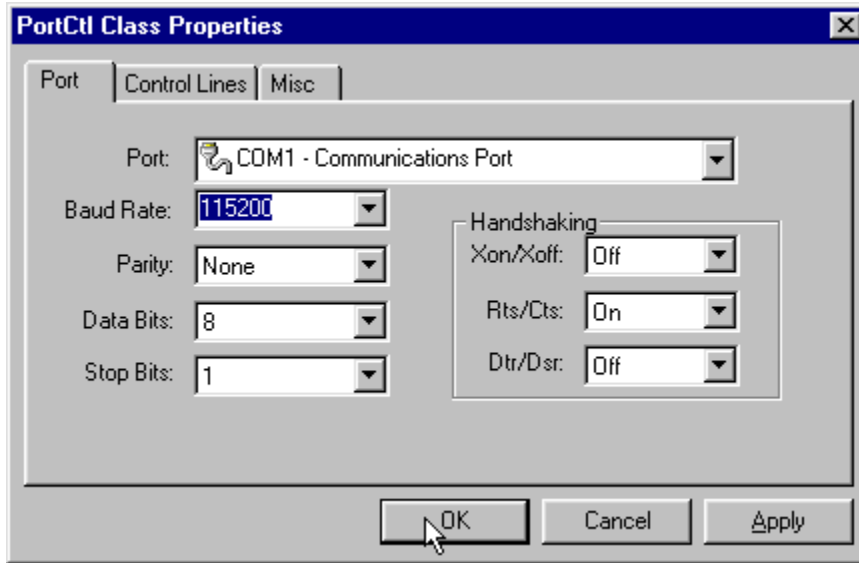

Generally, these default settings should not be changed:

- Baud rate: 115200 (default)
- Parity: None (default)
- Data Bits: 8 (default)
- Stop Bits: 1 (default)

Do NOT change the "Handshaking" settings:

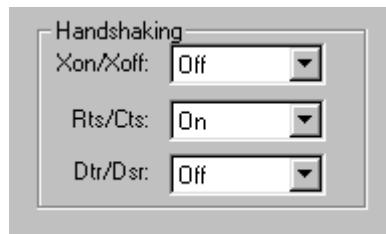

Select the COM port to be used from the drop-down list. The COM port refers to the hardware connectors that allow the computer to COMMunicate with other devices (like a printer or an RadioLinx wireless modem or switch) through cables. COM ports are usually located in the back of the computer.

The RadioLinx Setup Application automatically determines and displays the serial ports.

NOTE:

Detect the identity of each COM port:

- **look** for a COM port label near the serial port connector on the back of the PC
- **consult** the computer's documentation
- **check (and/or adjust)** the PC's BIOS settings
- **experiment**, trial-and-error

In general, the factory-set defaults will not have to be changed.

Click **Ok** to accept the current settings.

See Serial Port Factory Default Settings for an illustration of the factory-default serial port settings.

Serial Port Factory Defaults Illustrated

From any of the three associated dialog boxes, select:

- the **Ok** button to confirm/enter any changes made and return to the application's main screen.
- the **Cancel** button to discard any changes and return to the application's main screen.

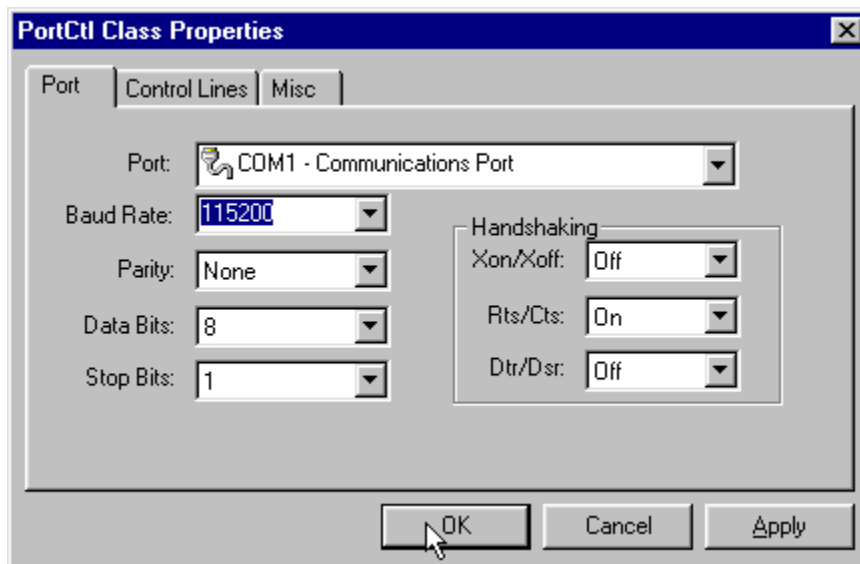

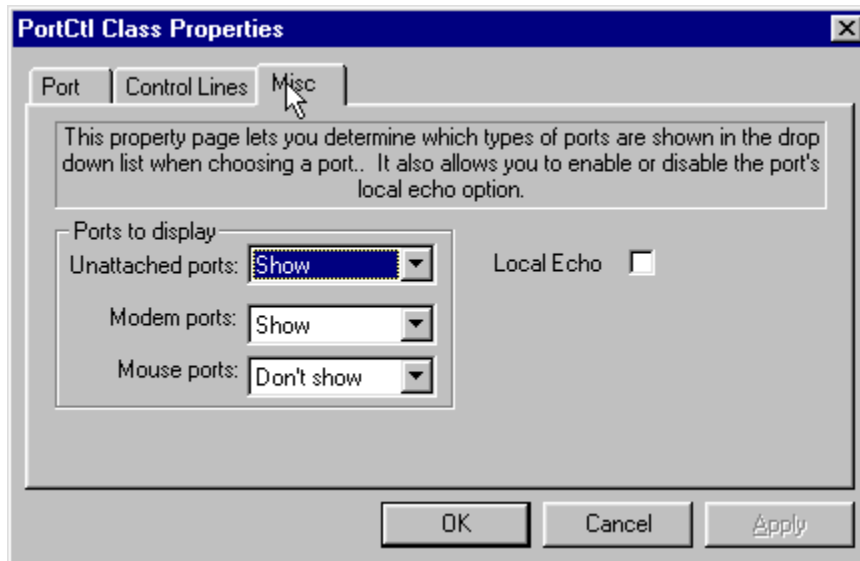
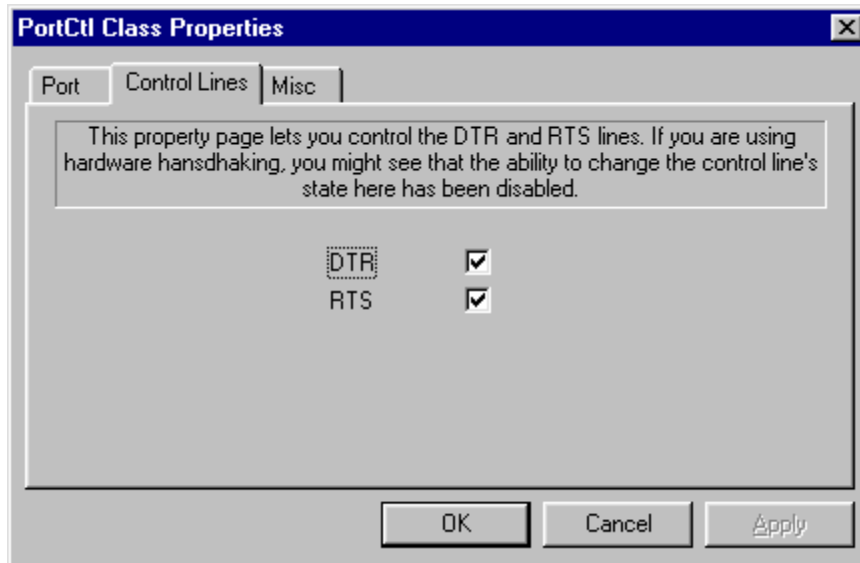

Ethernet Port Settings

Ethernet Start

The RadioLinx software is used to configure the radios, but can perform that function only if it "knows" how the network is organized and how all of its components are set to operate. The installation of any new RadioLinx network therefore requires that you introduce the hardware to the software

The configuration of a new network in the RadioLinx software requires these steps:

1. **Identify and characterize the Configuration PC's serial port to use the software**

The Configuration PC communicates with each radio via a serial port (also called a *COM* port). Many PCs contain more than one serial port, and there is some variation in the ways different serial ports function. The Configuration PC's serial port must therefore be identified and configured in the RadioLinx software when the network is installed.

The Serial port will be used to configure the Ethernet radio and to do Diagnostics on that specific radio.

2. **Choose a default color for the network's radio icons, as you want them to appear in the software's graphical representation of the network.**

When you define a new network, the software will create a single Remote radio, and its icon will be set to the color you specify as the network default. You can later change the default color for additional Remote. A radio's icon color cannot be changed after the radio has been defined as part of a network.

3. **Define the new network, as a whole, to the RadioLinx software.**

To define a new network you simply choose a name for the overall network, and define its type and channel. The original network definition configures a simple two-element network consisting of the Master radio and a single Remote radio. If you are installing two radios in your Ethernet network, skip ahead to step 5. If you are install more than two radios, you must also...

4. **Add other radios to the overall network definition in the software.**

5. **Save the network definition.**

After the network as a whole is defined in software, each of its individual radios must be configured in software, one radio at a time.

6. **Configure each individual radio in the network.**

Configure all Remote/Repeater radios first, and then (last) configure the Master radio.

7. **When the network and all of its radios have been configured in the software, physically label each radio, to eliminate any future confusion about which hardware radios correspond with which radio configurations in the software. Each label should identify:**

- ◆ The radio's "name" (the icon label in the software's graphical layout screen), and whether it is a Master or Remote radio (if the name doesn't indicate this).
- ◆ IP Address
- ◆ Subnet Mask
- ◆ MAC ID
- ◆ Network Channel

Continue the installation by physically installing the radios and antennas.

Ethernet Addressing Overview

Setting The IP Address of the Host Computer



If unfamiliar with changing IP Addresses, contact your Network Administrator.

The IP address of the host computer that runs the setup software, needs to be changed only if you are going to select an IP address for the radios that reside on a different sub network (a network with a different network ID) than the sub network currently configured.

For example, if the setup computer has an IP address of 207.4.1.3 in the TCP/IP client network configuration and you want to program the IP address for the radio to 192.168.15.1, then you will have to set up the host computer with an IP address on the same network (e.g. 192.168.15.10). This will allow you to use the setup software to perform radio network diagnostics. (See section 4.1 on performing network diagnostics).

IP addresses are in the following format: www.xxx.yyy.zzz - called 'dot format'

Classes of IP addresses are determined by value of the first 'octet' (the 'www').

The classes are as follows:

Class	First Octet Value	Network Identifier	Device Identifier	Subnet Mask
A	1-126	'w.' values	'x.y.z' values	'255.0.0.0'
B	128-191	'w.x' values	'x.y' values	'255.255.0.0'
C	192-223	'w.x.y' values	'x' values	'255.255.255.0'

The Subnet Mask is used to distinguish the Network ID and the Device ID.

For Example:

An IP address of 192.168.15.4 is on the Network 192.168.15; and the Device ID is 4.

An IP address of 10.120.22.75 is on the Network 10 and the Device ID is 120.22.75.

Setting The IP Address of the Host Computer

Setting the IP Address (note: screen shots are from windows me)

 *If unfamiliar with changing IP Addresses, contact your Network Administrator.*

Go to Windows 'Control Panel' and select 'Network'.

Select the TCP/IP protocol for the Ethernet Adapter.

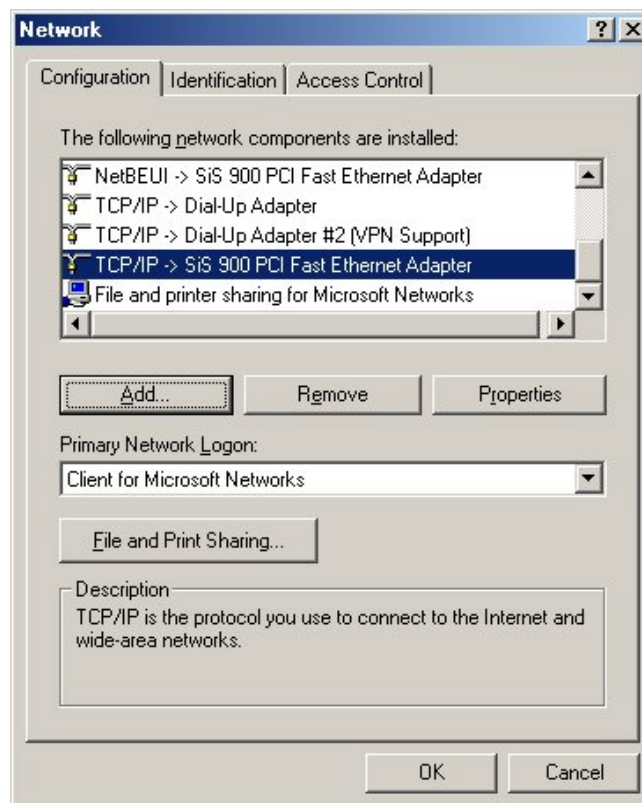

Select 'Properties' and click on 'Specify an IP Address'

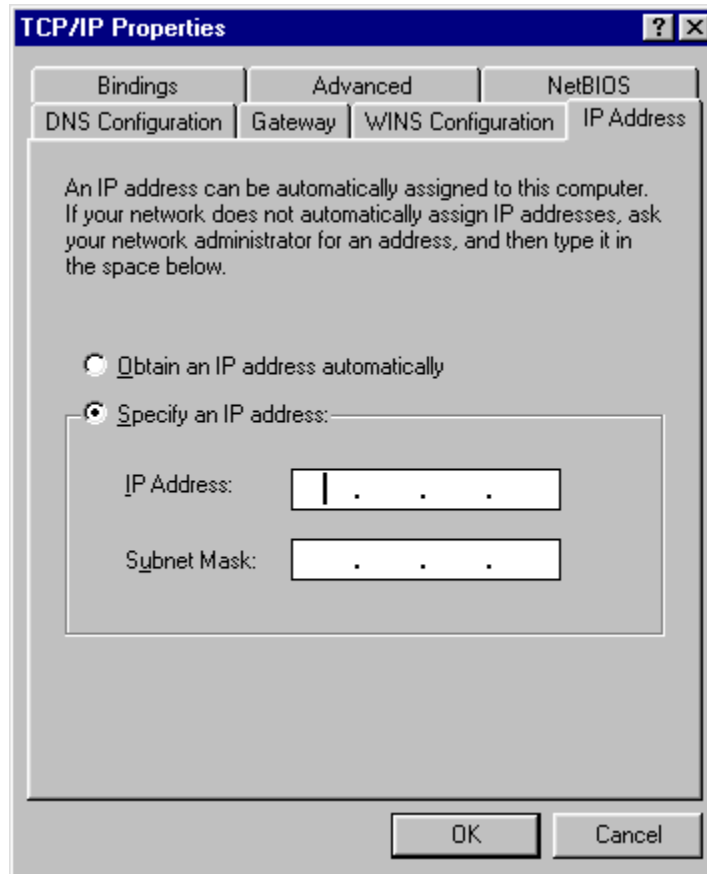

Enter the TCP/IP address for the host computer. This address should have the IP address of the network radios except for the un-masked region.

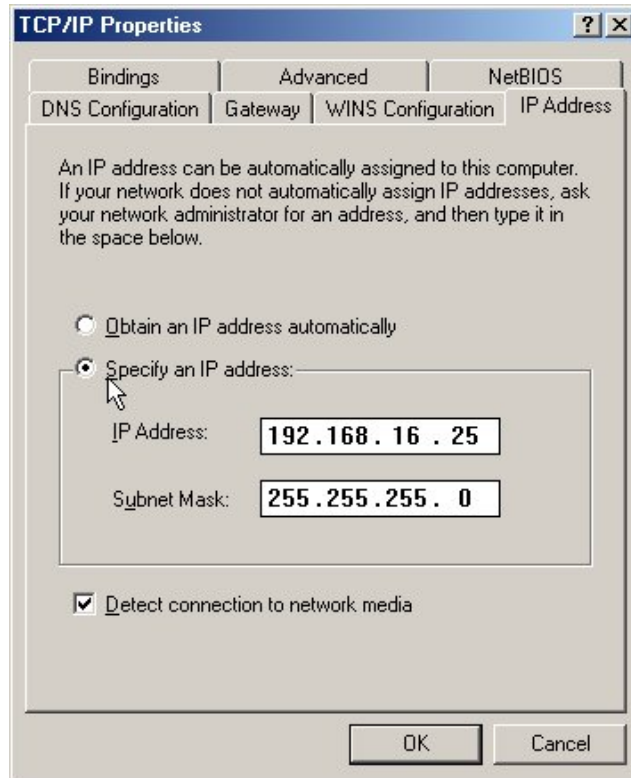

Enter a subnet mask that corresponds to the class of network desired. As an example, for a Class C sub network (256 device ID's per sub network) enter a subnet mask of 255.255.255.0.

Click 'OK' and restart the host computer to activate the settings.

Setting the Ethernet Port

To set the Configuration PC's IP setting, from the main menu of the RadioLinx Setup Application's **Main Menu**, select:

- ▶ **Port Setup**
- ▶ **Ethernet Port Configure**

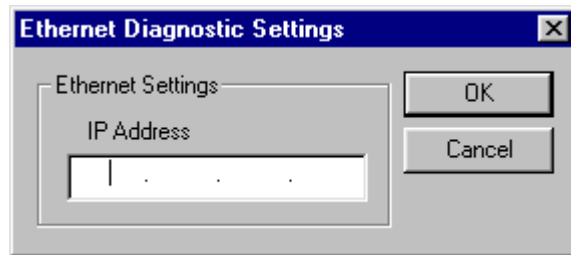

Enter the IP Address of the radio that is connected to the Configuration PC.

NOTE: This setting is for Diagnostics of an Ethernet Network only.

Network Configuration

Select Radio Color

While the color of radio icons does not affect a network's function, some applications may be more clearly represented with color-coded radios. Radio color can be set for the **entire network** or for **individual radios**.

NOTE:

If radio colors other than the default color are to be assigned, they must be assigned first, **before** the overall network or individual radios are configured. This is the only time a **global** network color may be picked, before the network is first configured. **Unique** colors for **individual** radios may be selected when individual radios are later added to existing Point-Multipoint networks of either variety.

To set color for the entire network, select the following from the RadioLinx Setup/Diagnostic Application **Main Menu**:

- ▶ **Utilities**
- ▶ **Set Radio Color**

The **Radio Color** dialog box appears (as shown here):

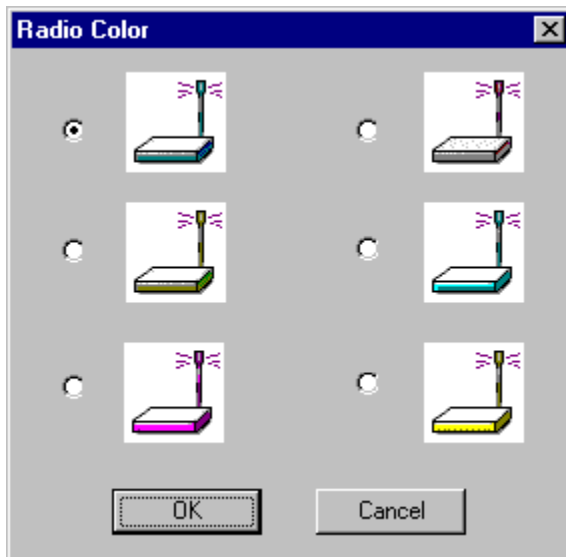

Select the radio color to be initially used by the entire network (**individual** radios with **unique** colors may be added later to existing Point-Multipoint networks of either variety) and select **Ok** or press **<Enter>**. With this action, the dialog box goes away and the focus is returned to the **Main Menu**.

Then, from the Main Menu:

- ▶ **Configure**
- ▶ **New Network**

The New Network dialog box appears as shown below:

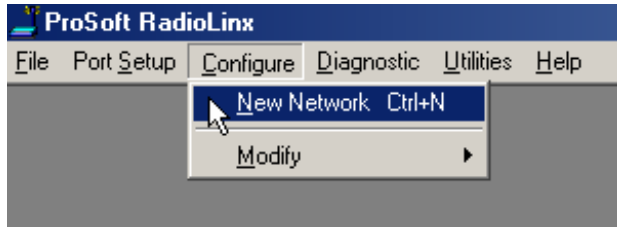

To set a different color for the entire network, select the following from the RadioLinx Setup/Diagnostic Application **Configure Menu**:

- ▶ **Radio**
- ▶ **Set Radio Color**
- ▶ **Radio**
- ▶ **Add**

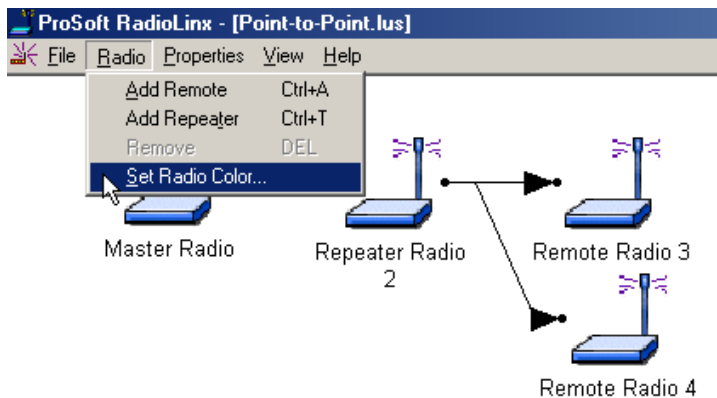

Click **Set Radio Color** to bring up the **Radio Color** selection box:

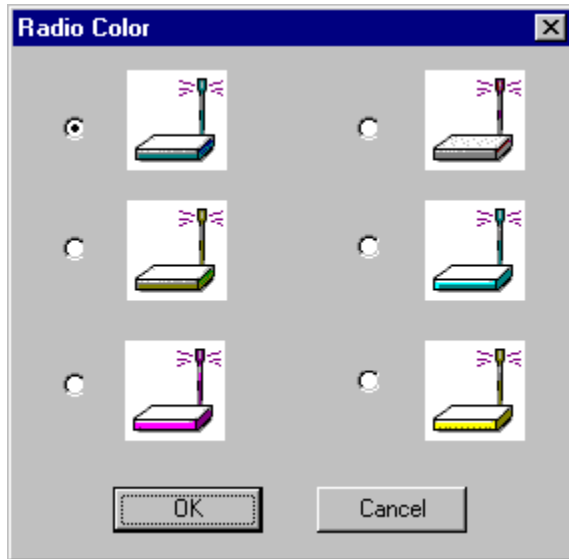

NOTE: When radios are first added to a network they appear grayed out. Once configured the radios will be the same color chosen.

Define Network Name, Type, Channel

From the main menu of the RadioLinX Setup Application, select:

- ▶ **Configure**
- ▶ **New Network**

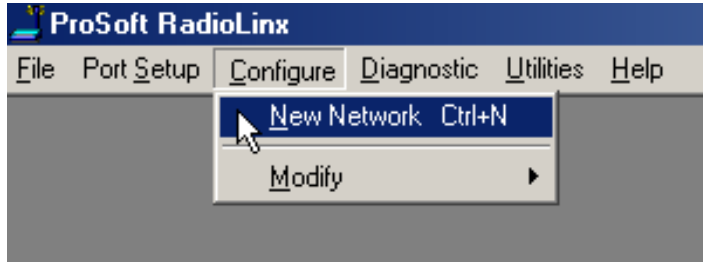

A Network Properties dialog box is displayed where the basic parameters of the new network are defined:

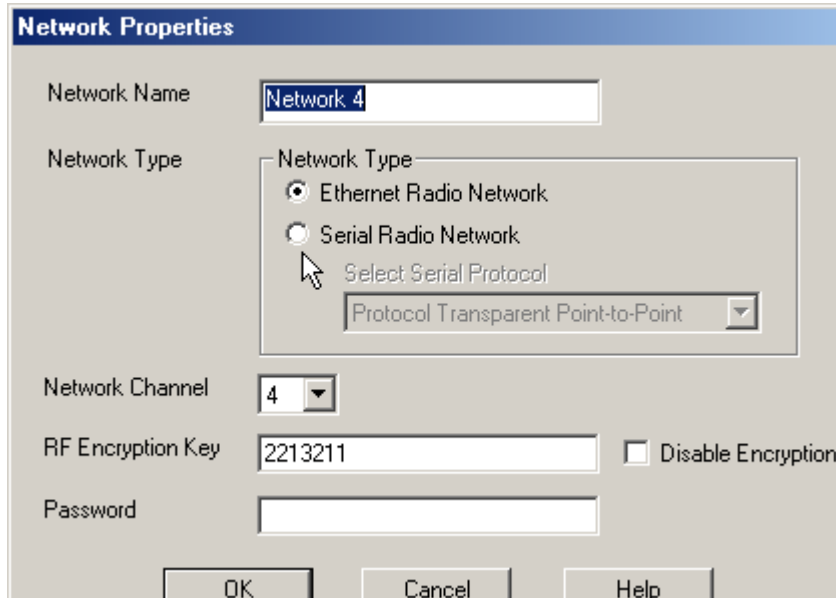

- **Network Name:** Use up to 20 alphanumeric characters. The RadioLinX Setup Application will use this assigned name in all subsequent references to this network. The network name cannot easily be changed. The recommended procedure is to choose a name at the time of network definition which will be recognized by those responsible for future network maintenance
- **Network Type:** From the drop-down list, select one of the following:
 - Protocol Transparent - Point-to-Point
 - Protocol Transparent - Broadcast
 - Modbus RTU
 - Modbus ASCII
 - DNP
 - RadioLinX OEM Protocol

- Dialup Modem Emulation
- Ethernet

See Network Types in this Help system for an illustration of the available network types.

- **Network Channel:** From the drop-down list, select a channel for the network. Network channel selection is used to allow the operation of up to 32 different networks in the same location. There may be a total of up to 2047 radios per network (including the master radio and its remote radios). The following network channel requirements **must** be met for full network functionality:
 - The Master Radio and Remote Radio (or Radios) of each network must be assigned to the **same network channel**.
 - Networks in close proximity must be assigned to **different channels**.

Network channel selection is used to allow the operation of several networks in the same location. If the same network channel is selected for two networks that are close to each other, the networks will interfere with each other, and may not communicate at all.

The RL-2400E can support 32 channels.

- **RF Encryption Key** The value entered in this field is translated into a 40-bit key used by the radios when encrypting packets sent over the air. The value entered must be between 5 and 7 characters. The allowable values are the alphanumeric characters 'a' through 'z' and '0' through '9'. The values are **case insensitive**.

All radios in a network must be programmed with the same encryption settings.

- **Disable RF Encryption Check Box:** When this box is checked, radios will be programmed to not encrypt packets sent over the air. ProSoft Technology recommends that encryption is not disabled. In addition to providing security from intentional attempts to access your network, encryption prevents inadvertent access between two networks using the same channel number in the same geographical area.

Note: Encryption parameters may be modified subsequently. To access **Network Properties** after a network has been initially defined, select **Modify** followed by the *Network Name* on the **Configure** menu on the **Main** screen. Once in the **Network Configuration** view, select **Network** on the **Properties** Menu.

- **Configuration File Password:** The value entered into this field is used to restrict access to Network Configuration through the RadioLinx Setup and Diagnostics Software. Password protection of the configuration file prevents unwanted access to any configuration settings including the encryption key used.

The value entered must be between 5 and 7 characters. The allowable values are the alphanumeric characters 'a' through 'z' and '0' through '9'. The values are **case insensitive**.

Once this value has been entered and confirmed in a subsequent screen, Network Configuration can be accessed only when the correct password is provided. **If it is forgotten, a new Network will have to be defined.** If no password protection is desired, leave the field blank.

Ok: to confirm/enter the selected network configuration and proceed to the graphical layout screen.

Cancel: to close the Network Properties dialog box and discard any changes made to the network properties.

Once the OK button has been clicked, the software will perform checks on the validity of the RF encryption key (if not disabled) and the password (if not left blank).

Invalid Encryption Key

If the encryption key is not valid, the following dialog box will appear.



The key must be between 5 and 7 characters. The allowable values are the alphanumeric characters 'a' through 'z' and '0' through '9'. The values are **case insensitive**.

Password Invalid

If the password is not valid, the following dialog box will appear.



The password must be between 5 and 7 characters. The allowable values are the alphanumeric characters 'a' through 'z' and '0' through '9'. The values are **case insensitive**.

If no password protection is desired, leave the field blank.

Password Confirm

If the password is valid and not blank, the following dialog box will appear to confirm the password.



This dialog box is used to confirm the password that is used to access Network Configuration through the RadioLinx Setup and Diagnostics Software. Make sure to remember the password used. Once it is entered, configuration cannot be accessed without it. If it is forgotten, a new Network will have to be defined.

If no password protection is desired, press Cancel to return to the Network Configuration dialog box and remove the password there.

Password Mismatch

The Password Mismatch dialog box appears when the value entered in the Confirm Password field is not the same as the value entered in the Configuration File Password field of the Network Properties.



Click "OK", which will return you to the Network Properties dialog box. Then re-enter the password and try again.

NOTE:

Maintenance of the network should be considered when the network is graphically configured. When the network is graphically defined, it should be arranged so that its function can be easily determined by someone other than the designer. By convention, the Master radio is the left-most icon with the Remote radio(s) lined up to the right. This is for clarity as well as assisting performance of visual maintenance on the network icons.

Graphical Layout Screen

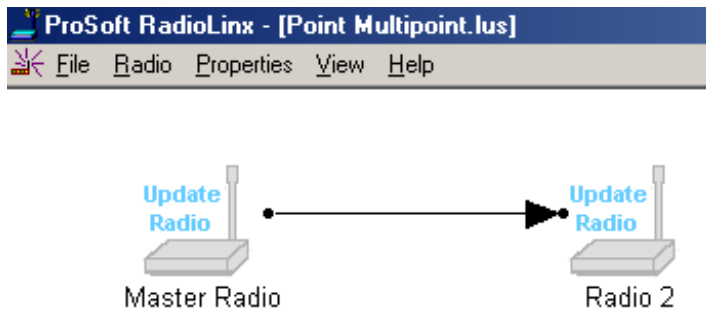

A graphical illustration of a basic two-radio network and its communication path (RF link) is displayed when the settings of the Network Properties dialog box are accepted. Each radio icon has a radio name displayed underneath it to identify the radio. The radios will appear grayed out and labeled update radio until they are configured. (This is the default.)

Add additional Repeaters with Add Repeater Radio function or Remote radios with the Add Remote Radio function.

NOTE: Any Remote Radio can be changed to a Repeater Radio and any Repeater Radio can be changed to a Remote Radio.

Adding Remote Radios to a Network

The radios can be displayed in different colors or simply use the standard default color. The color of a radio does not affect the function of the network, *however*, there may be an application that can be more clearly represented with color-coded radios. When defining a color, the color **must be defined before the radio is added**.

From the RadioLinx **Configure** menu, select:

- ▶ **Radio**
- ▶ **Add**

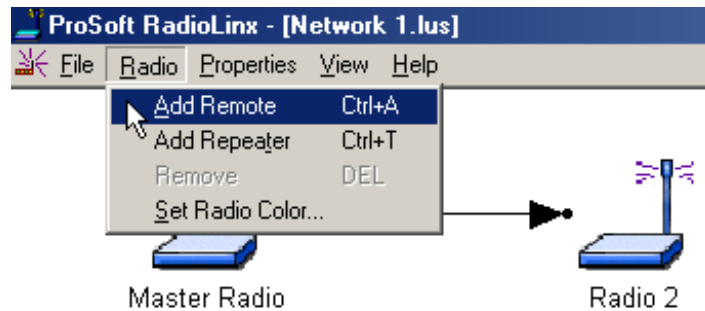

The new radio icon image appears and is superimposed over part of the Master Radio icon.

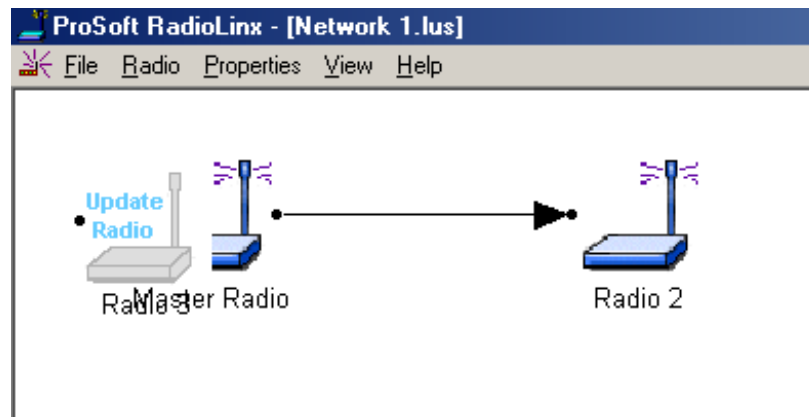

Move the additional Remote radio icon.

NOTE:

See When to Re-Configure Radios to ensure all radios will be updated.

Adding Repeaters to a Network

The following screen shot shows where to find **Add Repeater** to the Network. After selecting the add repeater function from the menu, a repeater icon will appear on the Graphical User Interface (GUI).

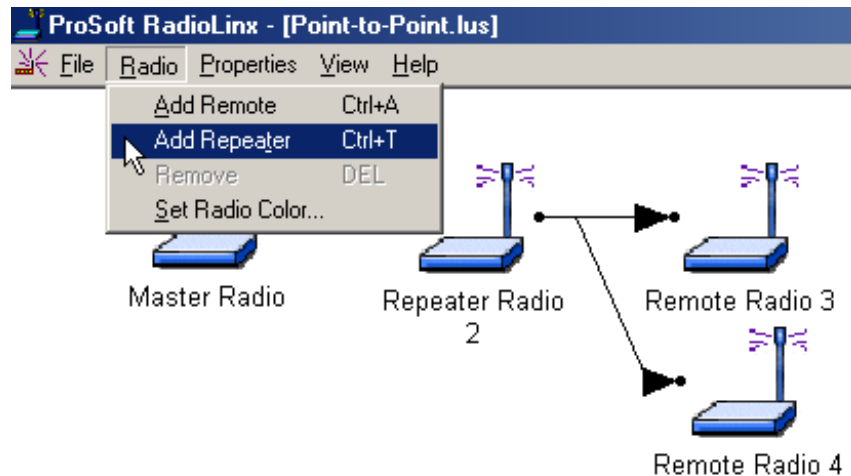

NOTE:

SEE WHEN TO RE-CONFIGURE RADIOS TO ENSURE THAT ALL RADIOS ARE UPDATED.

The repeater radio will have a link point (black dot) on both the right and left side of each repeater radio. The remote radio has only one link point located on the left side of the radio. As with all new radios, it will show the radio needs to be updated.

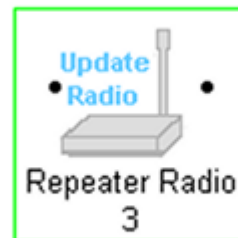

Initially, a new network will start out with a Master radio and a Remote radio connected by the RF link. To add a Repeater, the RF link between the Master and Remote will need to be deleted. Once the Repeater is in place and RF links are connected, the Repeater's setting can be adjusted.

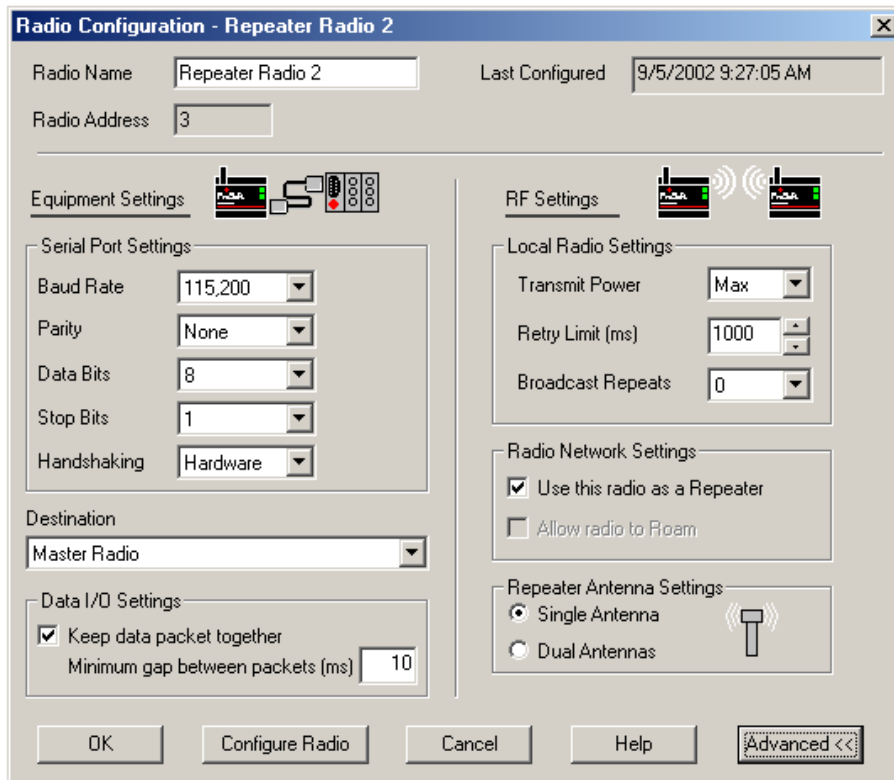
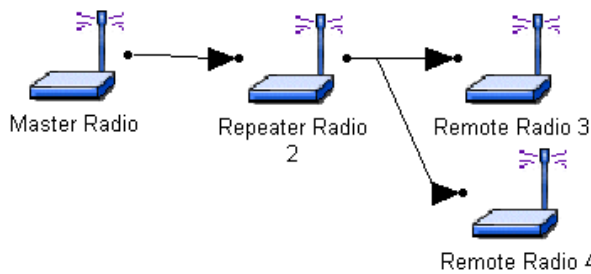

An additional setting for Repeaters is the selection of antenna(s) for the Radio Network Settings. The Radio Network Settings is used for selecting the number of antennas needed for communicating with the entire network.

The **Single Antenna** setting on the repeater can be used when an antenna is attached to antenna (B) for communicating back toward the Master radio (Reverse) and antenna (A) for communicating toward the Remote radios (Forward) that are in the path of the Repeater. Antenna Diversity is always "ON" when the Repeater is communicating in the reverse direction.

The **Dual Antennas** setting can be used if the Repeater uses the **same** antenna to communicate with the other radios in the network. When the Shared Antennas button is selected the antenna would be attached to antenna (A). The Antenna Diversity feature could also be used in the Shared Antennas mode by connecting a secondary antenna to antenna (B).

Graphically Define the RF Link

Radio communication links between radios must be defined. The RadioLinx Setup/Diagnostic Application uses lines between radios to graphically define the RF communication links in a network.

Use the left mouse button to select the Master radio's link point (the black dot to the right of the Master radio icon).

NOTE:

Select the Master radio's link point (only) and not the Master radio icon itself. If the Master radio is selected (surrounded by a colored box), left-click anywhere else on the screen to de-select the Master radio icon.

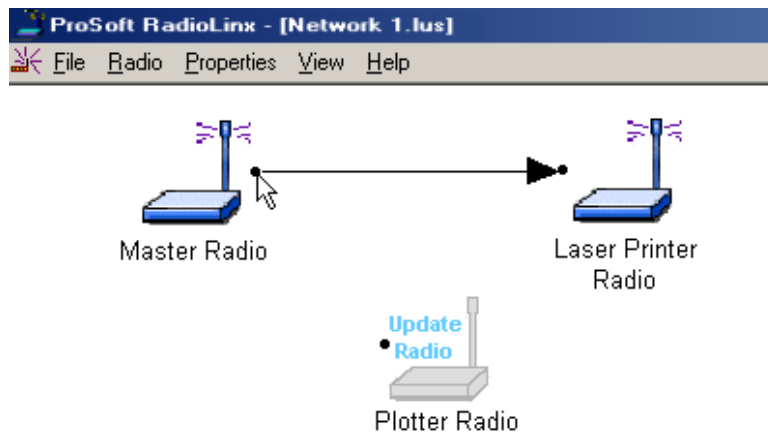

Hold left mouse button down and drag the RF link to the Remote radio's link point (located to the left of the Remote radio). As the mouse is being dragged, a line will appear between the Master and Remote radios. **This is the graphical representation of the RF communication link.** Once the mouse button is released an arrowhead will appear at the end of the graphical link line at the Remote radio's link point.

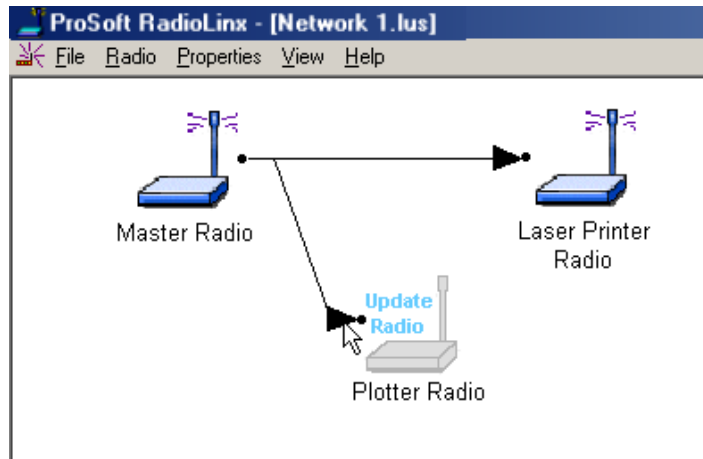

Auto Layout of Network Icons

Radios may be moved manually or aligned automatically. If the graphical representation of the network is disorganized, use the **AUTO LAYOUT** function to automatically redraw the network in a hierarchical structure based on the connections between the master radio and the remote radios. This structure is based on the order on that the radios were added to the network in the diagnostic window.

Before:

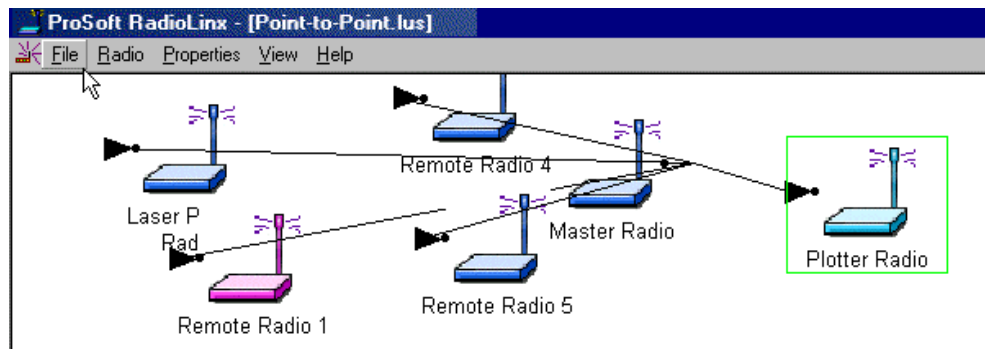

After:

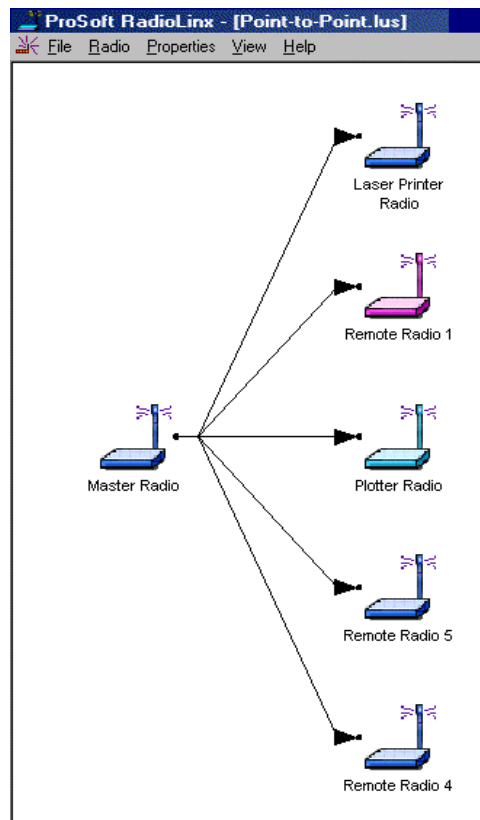

Default radio names can be changed.

Rename Radios

To rename an existing radio, access the **Radio Configuration** dialog box. From the RadioLinX Setup/Diagnostic Application's **Main Menu**, select:

- ▶ **Configure**
- ▶ **Modify** (the network by name)

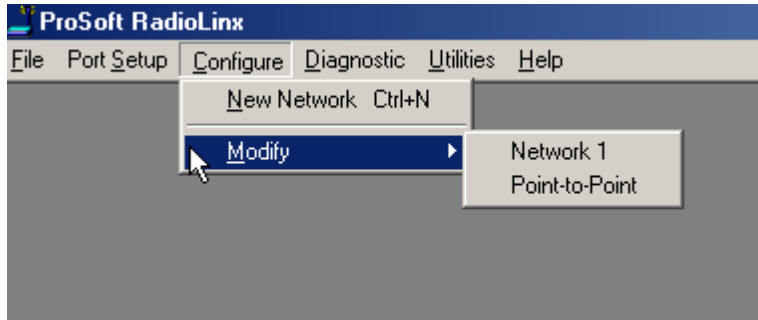

The **Graphical Layout Screen** is displayed. There are two different methods to access the Radio Configuration dialog box;

- **double-click** the radio's icon,
- OR**
- **highlight** the radio's icon by selecting it with a single left-click of the mouse and then choose the following menu items:
 - ▶ **Properties**
 - ▶ **Radio**

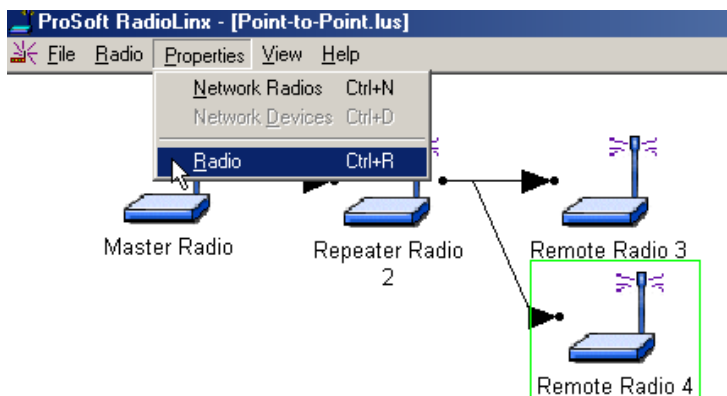

Type the Radio's new name into the **Radio Name** field. Click **Ok** or press <Enter>. (To learn more about the **Radio Configuration** dialog box and its specific settings, go to the modify radio settings section.)

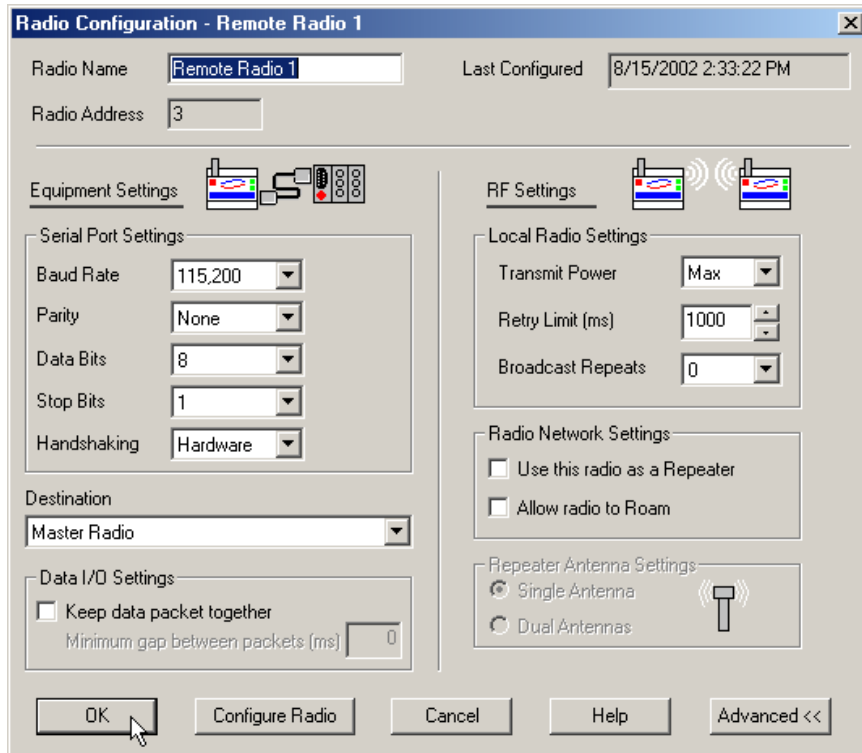

Change a Radio's Type

When radios are first added to a network, they are added as a Remote Radio or a Repeater Radio. However, it is easy to change the radio type after a radio has been added to the network. To change the radio's type, open its configuration dialog by double-clicking on the icon. In the Radio Network Settings is a check box 'Use this radio as a Repeater'.

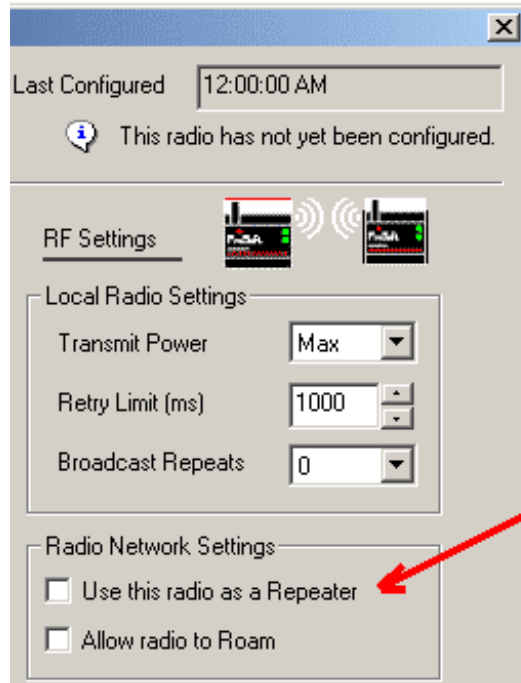

If this box is checked, the radio will be act as a Repeater. If it is unchecked it will not.

The figure below illustrates a two radio network.

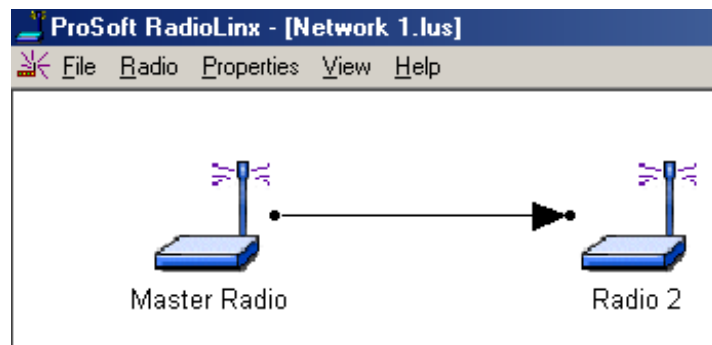

If you wish to expand the network, the second radio can be reconfigured as a repeater. Then additional radios can be added to expand the network. This is shown below after Radio 2 was changed to a Repeater and Radio 3 was added.

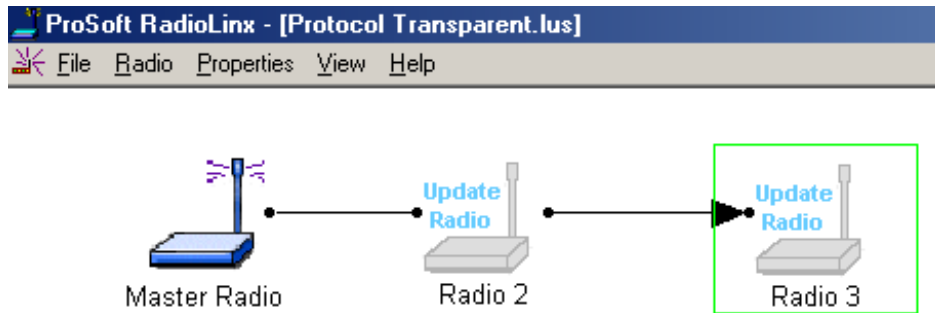

NOTE:

The Repeater and Remote radio type does NOT affect how the radio communicates with devices connected to it. A radio's type only affects whether other radios can be linked to it.

Delete a Radio

From the network's **Graphical Layout Screen:**

Select the icon for the radio to be deleted

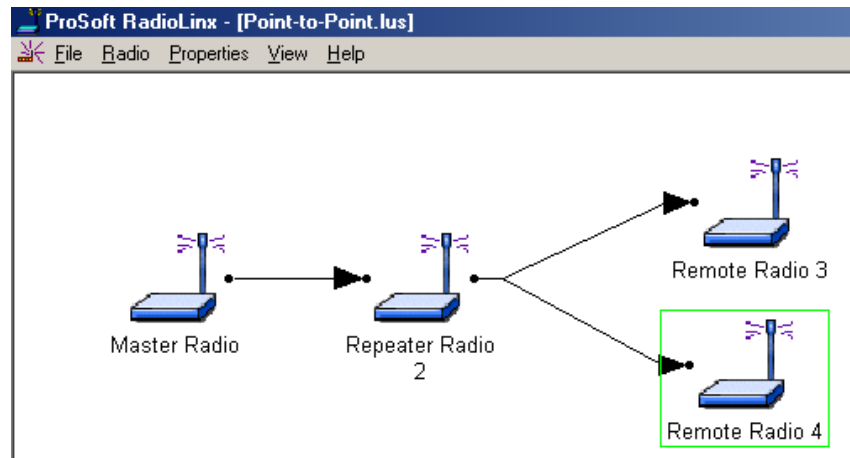

Click the following:

- ▶ **Radio**
- ▶ **Remove**

OR

Press the keyboard delete key:

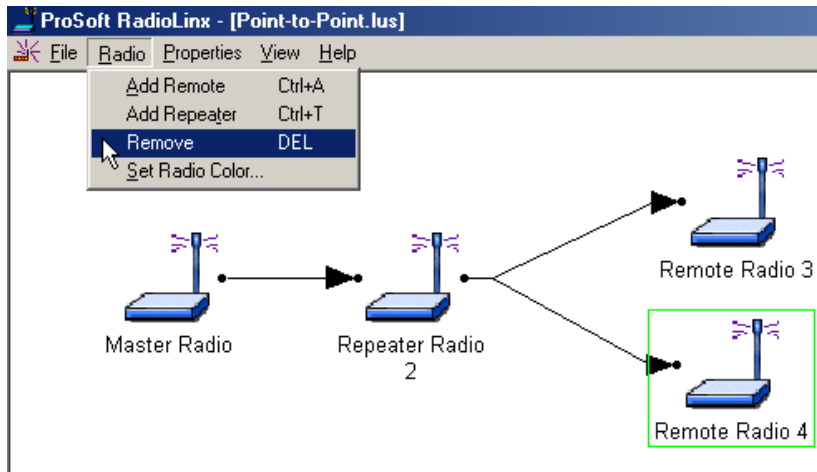

NOTE:

The Master radio **cannot be deleted**.

Save the Network's Definition

Save the Network's definition if:

- a new network has been defined
- changes have been made to the network's definition

From the **Graphical Layout Screen**, select:

- ▶ **File**
- ▶ **Close (or Exit)**

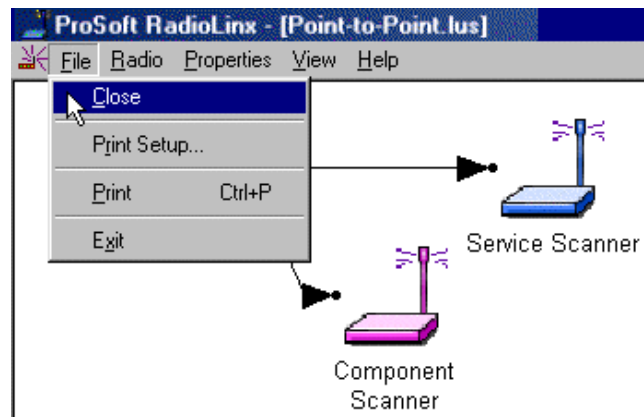

The standard Windows **Save As** dialog box will be displayed; the network name can be accepted as it is or it can be edited here.

NOTE:

THIS IS THE LAST TIME THAT THE NETWORK'S NAME CAN BE CHANGED.

Select:

- ▶ **Save**

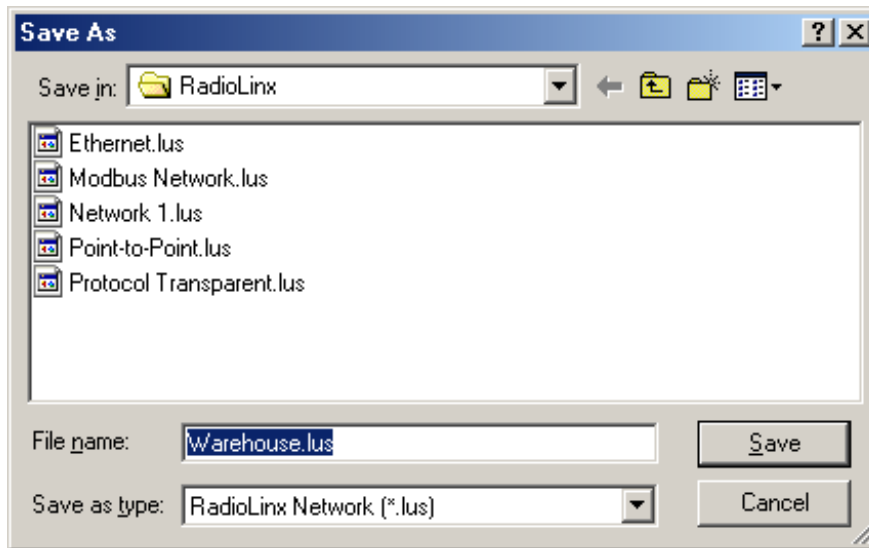

NOTE:

DO NOT change the default directory. The RadioLinx Setup/Diagnostic Application uses the default directory to maintain network-related data.

The Network's Definition can be printed.

Printer Settings

The **Print Setup** dialog box (see next) can be accessed from three different screens; **Main**, **Configure**, and the Network **Diagnostic** screen.

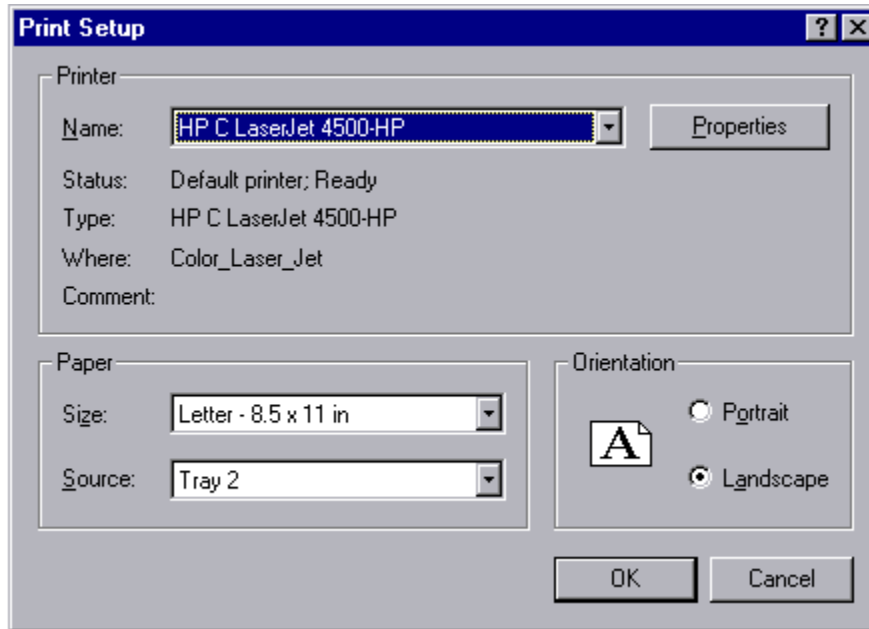

- **Main**

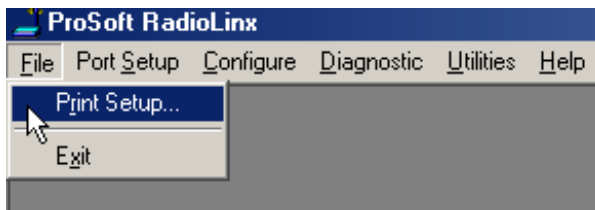

- **Configure (Modify Network only; not from New Network)**

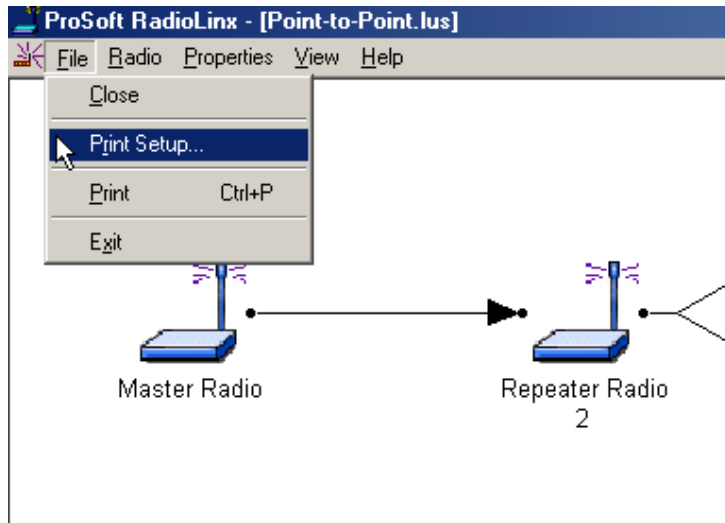

- **Diagnostic (Network only; not from the Radio screen)**

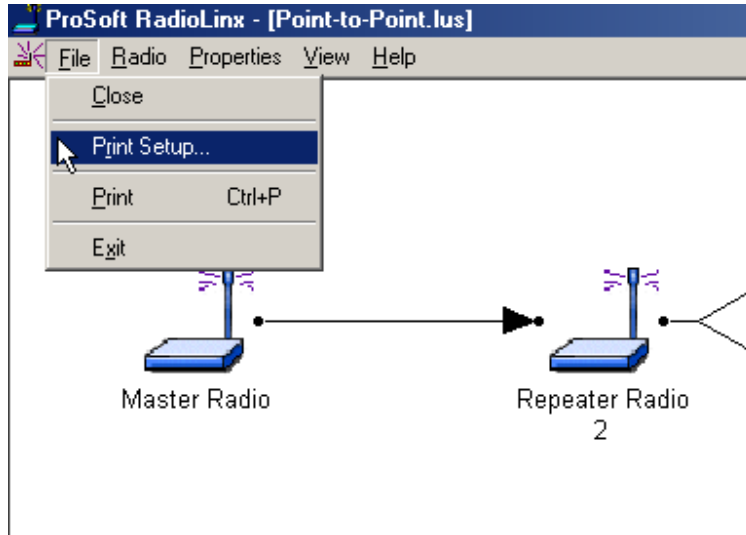

Print the Network's Configuration

Two different network configuration reports can be printed:

- **Print** from the **Configure** screen
- **Print** from the **Diagnostics** screen

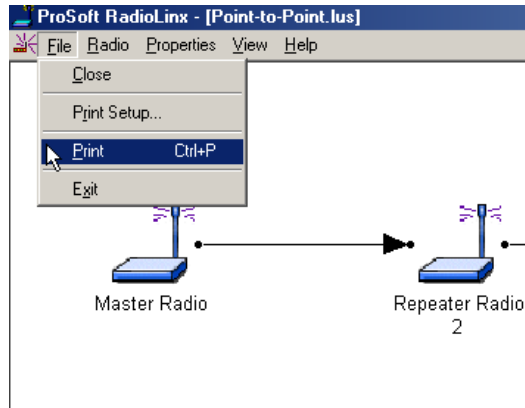

From the **Configure** screen:

- ▶ **File**
- ▶ **Print**

Prints a **text list of network parameters** that have been stored in the RadioLinX Setup/Diagnostic Application's internal database stored on the Configuration PC. (This list is especially useful for troubleshooting.)

Serial Network Configuration:

Name	Address	Power	Baud Rate	Parity	Databits	StopBits	Retry Limit
Master Radio	1	1mW	115200	N	8	1	64
Scanner Radio	2	1mW	115200	N	8	1	64

Ethernet Network Configuration:

Name	Address	Power	IP	Subnet	Retry Limit	Antenna
Master Radio	1	Low	192.168.16.98	255.255.255.0	64	Single
Remote Radio 1	2	Low	192.168.16.99	255.255.255.0	64	Single

From the **Diagnostic** screen:

- ▶ **File**
- ▶ **Print**

Prints a graphic representation of the network's current operating status (a visual "snapshot in time").

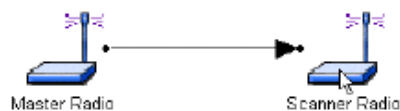

Radio Configuration

General Radio Configuration

Configure the radios themselves once the network is designed. Radios are configured **ONE AT A TIME USING THE CONFIGURATION PC**.

Use the specified cable and connect the radio to the Configuration PC's COM port as specified in the PC's serial port dialog box.

Access the **Radio Configuration** dialog box to set network-specific parameters for each individual radio. Starting from the RadioLinX **Main Menu**, select:

- ▶ **Configure**
- ▶ **Modify** (the network by name)

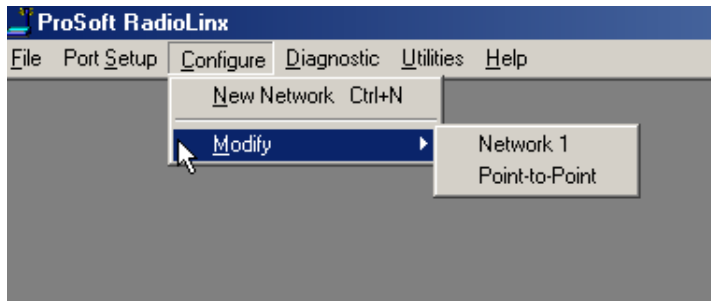

The **Graphical Layout Screen** is displayed. There are two different methods of bringing the dialog box up from the screen:

- double-click the **icon of the radio to be configured**,
- OR**
- highlight the **icon of the radio to be configured** by selecting it with a single left-click of the mouse and then choose the following menu items:

- ▶ **Properties**
- ▶ **Radio**

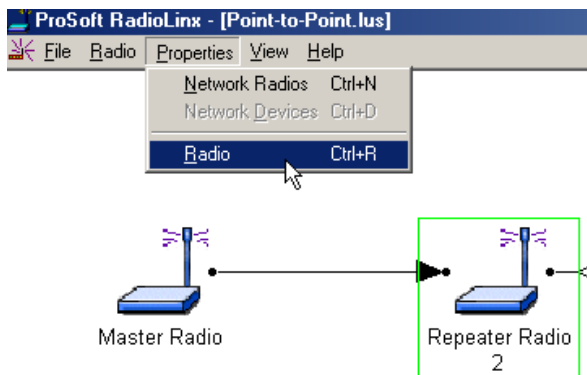

The **Radio Configuration** dialog box is displayed – the image of the dialog box is different depending on which of the network type the radio is incorporated into.

Continue to configure the radios depending on their network type:

- **Protocol Transparent Point-to-Point**
- **Protocol Transparent Broadcast**
- **Modbus RTU**
- **Modbus ASCII**
- **DNP**
- **RadioLinx OEM Protocol**
- **Dialup Modem Emulation**
- **Ethernet**

Radio Configuration - Protocol Transparent

The **Radio Configuration** dialog box (as shown) appears after selecting a radio's icon to view its properties.

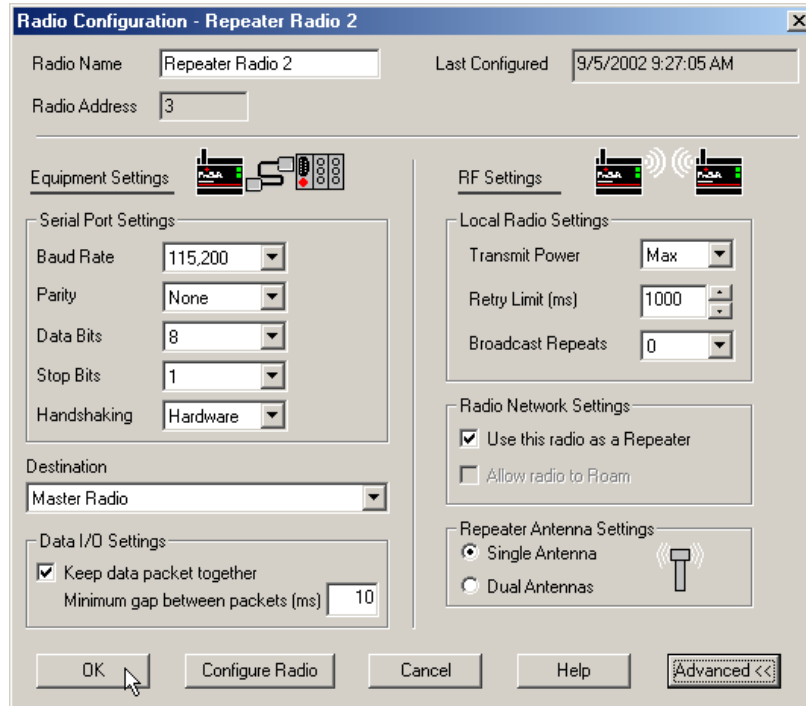

This configuration dialog box is used to configure radios for the following networks,

- Protocol Transparent Network
- RadioLinx OEM Protocol Network
- Dialup Modem Emulation Network

These network types are similar in that the radios are not configured with the IDs of the devices connected to them.

The following fields make up the **Radio Configuration** dialog box:

- **Radio Name:** The name of the radio entered in this field will appear as a label under the radio's icon on the Graphical Layout Screen. The name can be any combination of up to 100 alphanumeric characters and spaces.
- **Last Configured:** The date and time reported here indicates:
 - the last time that the configuration parameters were modified and saved
 - the last time the radio was configured (configuration data was downloaded to the radio).
- **Serial Port Settings:** The radio's serial port settings (*not* the Configuration PC's serial port settings).
 - Baud Rate (default = 115,200)
 - Parity (default = None)
 - Data Bits (default = 8)

- Stop Bits (default = 1)
- Handshaking (default = Hardware) Use the hardware default if the specific device supports it. For example, PCs support hardware handshaking.
- **Destination:** The destination field is enabled for Protocol Transparent Network configuration. It determines which other radio or radios this radio will send its data to. The field is disabled for the other network types.

NOTE:

When using the radios in a RadioLinx OEM Protocol Network, the destination is determined by the RadioLinx OEM Protocol packet header. When using the radios in a Dialup Modem Emulation Network, the destination address is determined by the "phone number" set when dialing.

- **Data I/O Settings:** Defaults to always keep the data packet together so that the information is complete. Minimum gap between packets instructs the radio to wait for a specific length of time to determine the data packet is complete.

NOTE:

The Serial Port Settings of each individual radio **must** match the device serial port settings cabled to the radio during normal network operation. The Configuration PC's serial port settings (baudrate, parity, data bits and stop bits) must match the radio's serial port settings. Changed radio serial port settings take effect once the radio is configured.

- **Radio Address:** The software assigns a unique address to each radio in the network once the radio is configured. (The user cannot change this addressing scheme – the address field is greyed-out.)
- **RF Settings** values adjust the over-the-air performance of the radio network:
- **Transmit Power:** Default is Max
- **Retry Limit (ms):** The transmitting radio will re-send the data as many times as set if there is an error in transmission. In normal transmission, the receiving radio "acknowledges" that the data has been received with no detected errors. If the transmitting radio does **not** get an acknowledgement, it will re-transmit until the retry limit has been met.
- **Broadcast Repeats:** Sets the number of times the radio will attempt to send the data.
- **Radio Network Settings:** This is for use with any radio except the Master. This dialog will be greyed-out when configured as a Master radio.
- "Use This Radio as a Repeater" turns any Remote Radio into a Repeater.
- "Allow Radio to Roam" allows the radio to search the network for the next available radio to send the information packet to.

Select the Configure Radio button to complete the radio's configuration. The Configure Radio button downloads radio parameters from the Configuration PC to the radio. (If the radio's configuration fails, consult the Diagnostics section.)

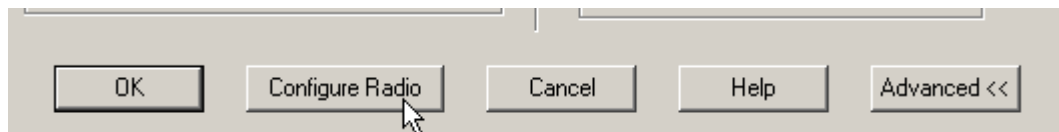

Save the configured settings as prompted by the RadioLinx Setup / Diagnostics Application Software once the configuration is complete.)

Return to the General Radio Configuration section if necessary to review how to start configuring radios for each of the network types.

Radio Configuration - Modbus & DNP Protocol

The **Radio Configuration** dialog box (as shown) appears after selecting a radio's icon to view its properties.

Radio Configuration - Repeater Radio 2

Radio Name: Repeater Radio 2 Last Configured: 9/5/2002 9:27:05 AM

Radio Address: 3

Equipment Settings

Serial Port Settings

Baud Rate: 115,200

Parity: None

Data Bits: 8

Stop Bits: 1

Handshaking: Hardware

Destination: Master Radio

Data I/O Settings

Keep data packet together

Minimum gap between packets (ms): 10

RF Settings

Local Radio Settings

Transmit Power: Max

Retry Limit (ms): 1000

Broadcast Repeats: 0

Radio Network Settings

Use this radio as a Repeater

Allow radio to Roam

Repeater Antenna Settings

Single Antenna

Dual Antennas

OK Configure Radio Cancel Help Advanced <<

The following fields make up the **Radio Configuration** dialog box:

- **Radio Name:** The name of the radio entered in this field will appear as a label under the radio's icon on the Graphical Layout Screen. The name can be any combination of up to 100 alphanumeric characters and spaces.
- **Last Configured:** The date and time reported here indicates:
 - the last time that the configuration parameters were modified and saved
 - the last time the radio was configured (configuration data was downloaded to the radio).
- **Serial Port Settings:** the radio's serial port settings (*not* the Configuration PC's serial port settings).
 - Baud Rate (default = 115,200)
 - Parity (default = None)
 - Data Bits (default = 8)
 - Stop Bits (default = 1)
 - Handshaking (default = None) Use the hardware default if the specific device supports it.

NOTE:

The Serial Port Settings of each individual radio **must** match the device serial port settings cabled to the radio during normal network operation. The Configuration PC's serial port settings (baudrate, parity, data bits and stop bits) must match the radio's serial port settings. Changed radio serial port settings take effect once the radio is configured.

- **Radio Address:** The software assigns a unique address to each radio in the network once the radio is configured. (If a radio's address is manually changed to an address already assigned to another radio in the same network, neither radio will communicate over the network. It is recommended that the user **DOES NOT** change this addressing scheme).
- **Associate ID:** In a Modbus or DNP network, each remote devices (Modbus or DNP) connected to the network need to be "associated" with the particular radio they are connected to. Use this button to set the unique device ID number(s) connected to this radio.
- **Modbus:** When associating IDs for Modbus, the following dialog is used.

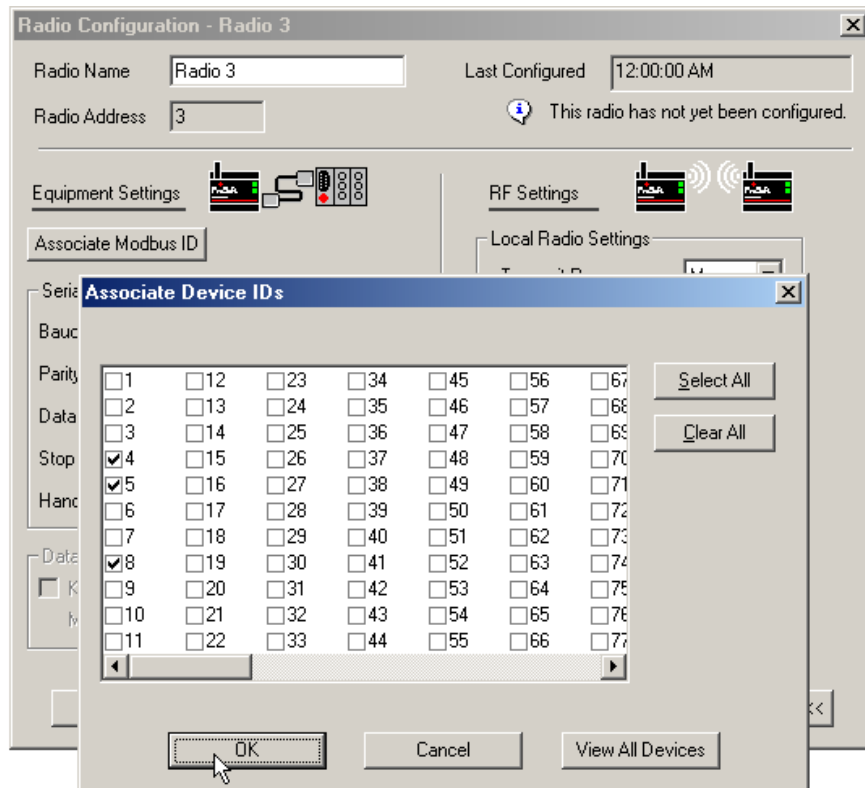

NOTE:

MODBUS ID NUMBERS ARE NOT ASSOCIATED WITH THE MASTER RADIO. ONLY THE MODBUS MASTER DEVICE MAY BE CONNECTED TO THE MASTER RADIO IN A MODBUS NETWORK.

- **DNP:** When associating IDs for DNP, the following dialog is used.

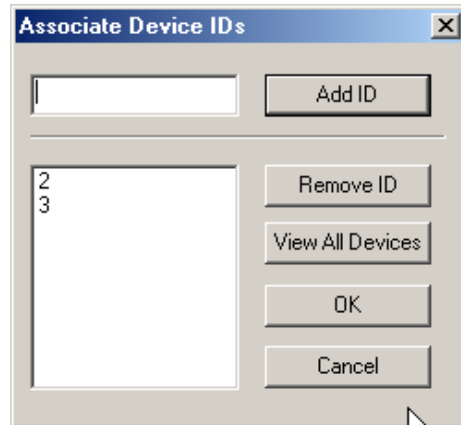

NOTE: If not sure of which IDs have already been assigned, select "View All Devices"

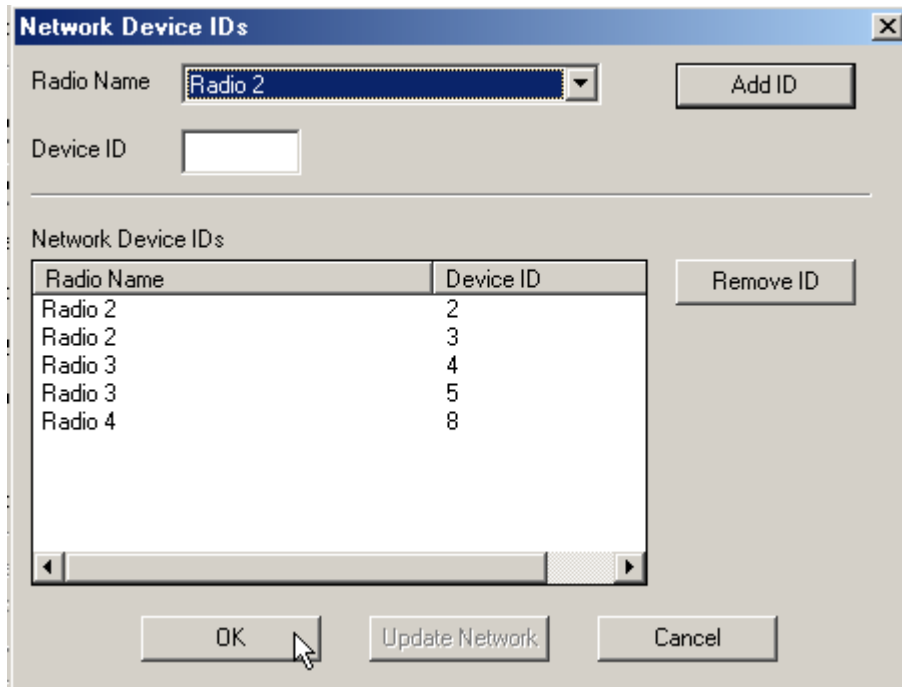

- **Radio Settings** values adjust the over-the-air performance of the radio network:
 - **Transmit Power:** Default is Max.
 - **Radio Network Settings:** This is for use with Repeater Antennas only. This dialog will be grayed-out when configured as a Master or Remote radio.
 - **Retry Limit (ms):** The transmitting radio will re-send the data as many times as set with the Link Retry Limit slider switch if there is an error in transmission. In normal transmission, the receiving radio "acknowledges" that the data has been received with no detected errors

Select the Configure Radio button to complete the radio's configuration. The Configure Radio button downloads radio parameters from the Configuration PC to the radio. (If the radio's configuration fails, consult the Diagnostics section.)

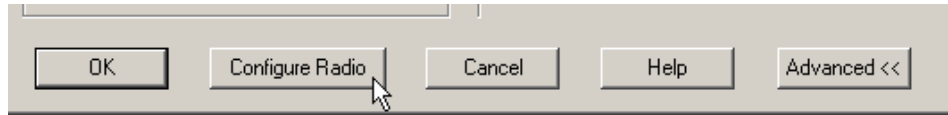

Save the configured settings as prompted by the RadioLinX Setup / Diagnostics Application Software once the configuration is complete.)

Return to the General Radio Configuration section if necessary to review how to start configuring radios for each of the network types.

Radio Configuration - Ethernet

The Radio Configuration dialog box (as shown) appears after selecting a radio's icon to view its properties.

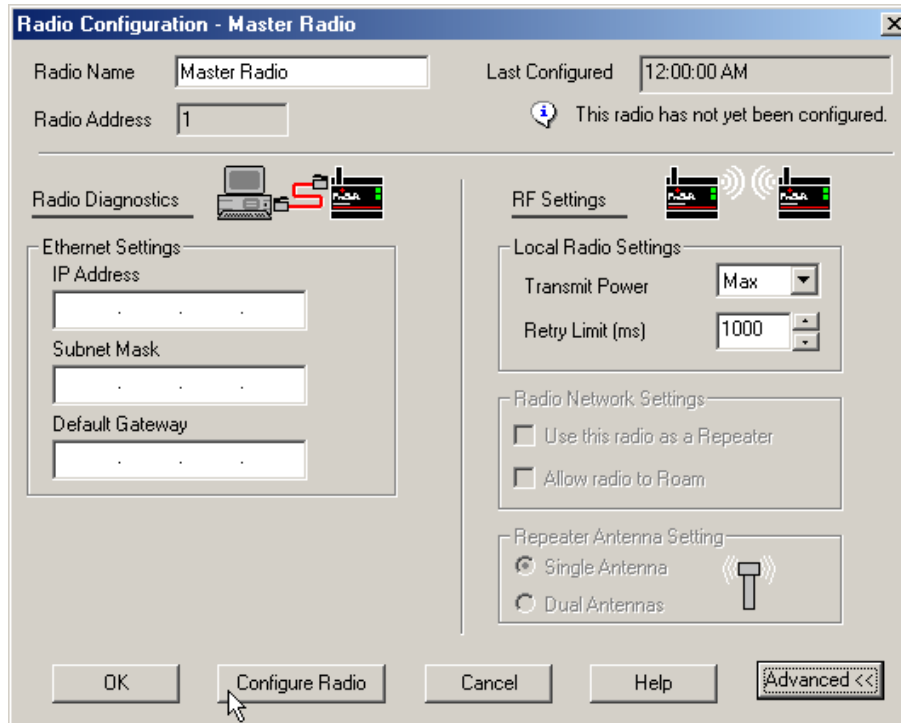

The Configuration Dialog Box

- **Radio Name:** The name of the radio entered in this field will appear as a label under the corresponding radio icon in the graphical layout screen. The name can be any combination of up to 100 alphanumeric characters and spaces.
- **Last Configured:** The date and time indicate the last time that the configuration parameters were modified and saved, and the last time the radio itself was configured (configuration data downloaded to the radio).
- **Ethernet Settings:** This shows the addressing of the radio within the Ethernet network.
- **IP Address:** This is the radio's identifier on the network. Each radio must have its own unique address to be able to communicate to the master on the network. This address must be different than any other device on the network including the Configuration PC.
- **Subnet Mask:** This defines the network ID and is typically set to 255.255.255.0. All Ethernet devices on a particular network should have the Subnet Mask set to the same value.
- **Default Gateway:** This defines the default network that the Configuration PC will operate on. The gateway is the computer that routes the traffic from a workstation to the outside network.
- **Radio Address:** The software assigns a unique address to each radio in the network once the radio is configured. These fields, which appear grayed-out in the dialog box, are indicators for reference only and cannot be changed by the user.
- **Radio Settings:** These values adjust the over-the-air performance of the radio network.
- **Transmit Power:** This setting should be set as *low as possible* while still providing a reliable connection to the receiving radio. A higher power setting than necessary could increase the distance required between two networks operating on the same channel.

- **Repeater Antenna Setting:** An additional setting for Repeaters is the selection of antenna(s) for the Forward/Reverse Links. This setting is used for selecting the number of antennas needed for communicating with the entire network. (This function will be grayed out if the radios are configured as a Master or Remote radio.)

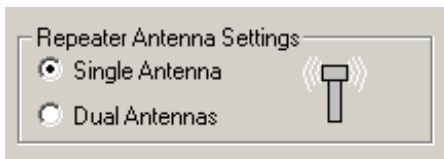

The Single Antenna setting on the repeater can be used when an antenna is attached to antenna (B) for communicating back toward the Master radio (Reverse) and antenna (A) for communicating toward the Remote radios (Forward) that are in the path of the Repeater. Antenna Diversity is always "ON" when the Repeater is communicating in the reverse direction.



The Dual Antennas setting can be used if the Repeater uses the same antenna to communicate with the other radios in the network. When the Shared Antennas button is selected the antenna would be attached to antenna (A). The Antenna Diversity feature could also be used in the Shared Antennas mode by connecting a secondary antenna to antenna (B).

- **Link Retry Limit:** If an error occurs in a transmission, the transmitting radio will re-send data several times, with a limit on retries as set by this slider switch (Low = few retries, High = many retries). In normal transmission with no errors, the receiving radio acknowledges receipt of transmitted data. If the transmitting radio does not receive an acknowledgement, it will resend data until it *does* receive an acknowledgement or until this Link Retry Limit is reached.

Save the configured settings as prompted by the RadioLinx Setup / Diagnostics Application Software once the configuration is complete.

Save the Radio's Configuration

Once the radio has been configured, select the following from the **Graphical Layout Screen**:

- ▶ **File**
- ▶ **Close**

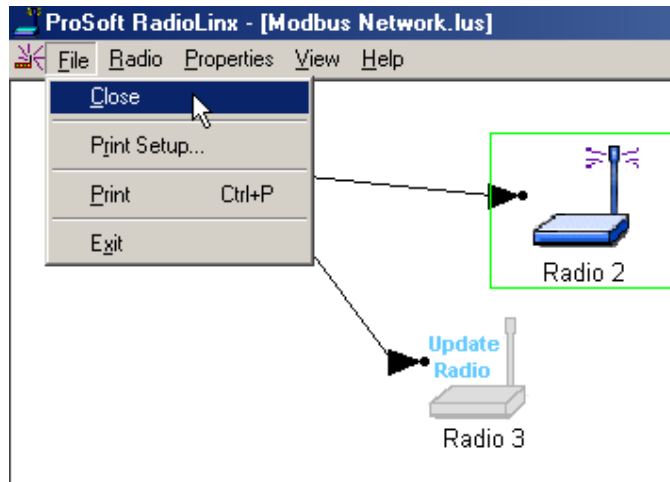

The following dialog box pops up asking if changes should be saved. Select **No** or **Cancel** if changes should not be saved or **Yes** at the pop-up dialog box (as shown here) to **save the radio settings**.

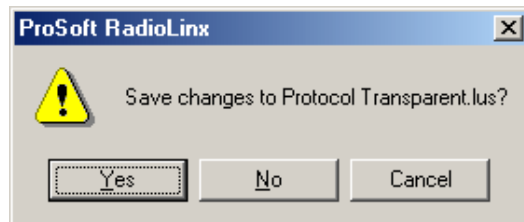

If **Yes** is selected, the radio settings are saved to the RadioLinx or RL-2400E or RL-2400S database file using the name of the network as its filename (.lus is the filename extension of each network's database file.) This information is added to the database file to keep the database current. When networks are modified, the RadioLinx Setup Application depends upon the retrieval of the network's configuration history. (This is why all network design and radio configuration must be done using the Configuration PC.)

Answer **No** to discard any changes.

The radio is now configured.

Physically label each radio with its role in the network (labeling can minimize future confusion regarding radio identities and roles):

- **Master or Remote** radio
- Baud Rate
- Channel

When to Re-Configure Radios

All radios need to be configured before initial installation in a network. In general, once radios are functioning in a network, they do not need to be re-configured if the network changes. The program will instruct when the radios need to be configured, as illustrated below:

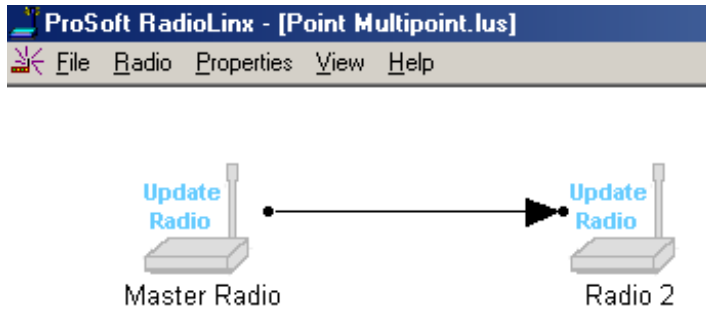

Once all the radios are configured, the graphical layout will be displayed as follows:

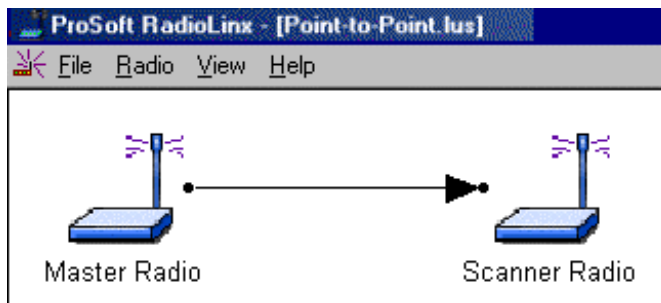

Existing Network Maintenance

Modify Network Settings

Existing networks contain several elements that may be edited. To modify network settings, select the following menu items from the **Main Menu**:

- ▶ **Configure**
- ▶ **Modify**

A drop-down list will appear to the right of the **Modify** function with a list of the existing network names (as shown here):

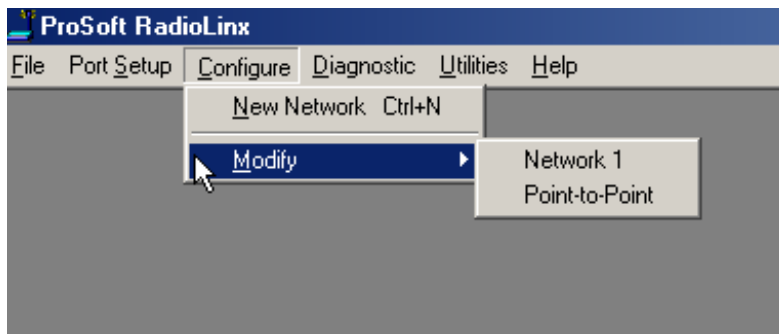

After selecting the name of an existing network, visit one of the following sections for detailed information on the various available activities:

- change a radio's settings (baud rate, output power, channel, etc)
- rename radios
- delete radios from a network (master radios cannot be deleted)
- ADD new radios

Password Protection

If no password protection was set up for the network, the "Configure" view will be opened. If password protection was set up, the "Configuration Access Password" dialog box will appear, requiring the user to enter the password before proceeding.

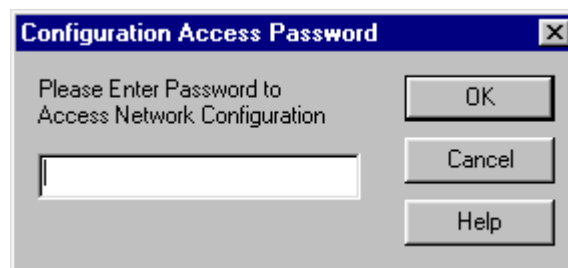

Passwords must be between 5 and 7 characters. The allowable values are the alphanumeric characters 'a' through 'z' and '0' through '9'. The values are **case insensitive**.

If the password has been forgotten, a new Network will have to be defined.

Once the password has been entered, it will be checked against the password in the file. If they do not match, the following dialog box will appear. Click OK to return to the "Configuration Access Password" dialog box to try again.

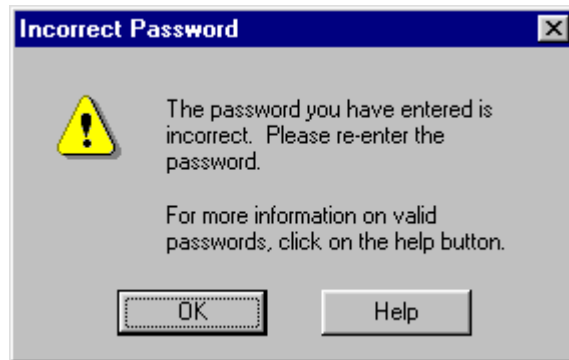

Passwords must be between 5 and 7 characters. The allowable values are the alphanumeric characters 'a' through 'z' and '0' through '9'. The values are **case insensitive**.

If the password has been forgotten, a new Network will have to be defined.

Assigning Device IDs Network Wide

Device IDs for Modbus and DNP networks can be assigned to radios through each radio's configuration dialog box or they can be assigned at once through the Network Device IDs dialog. Using the Network Device IDs dialog simplifies updating a network when new devices are added. It allows existing radios to be updated over the air.

To access the Network Device IDs dialog from the configuration view, select Properties, Network Devices:

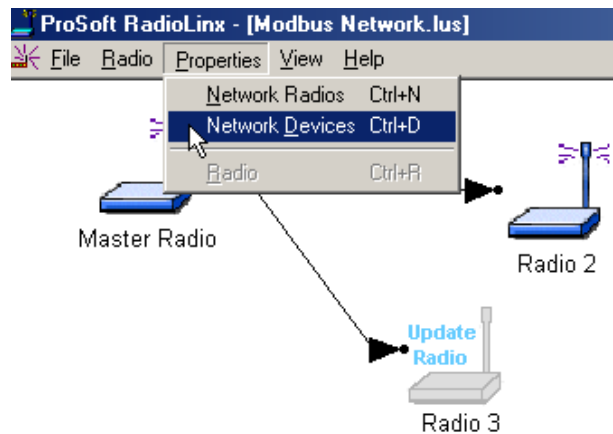

The Network Device IDs dialog box will then display:

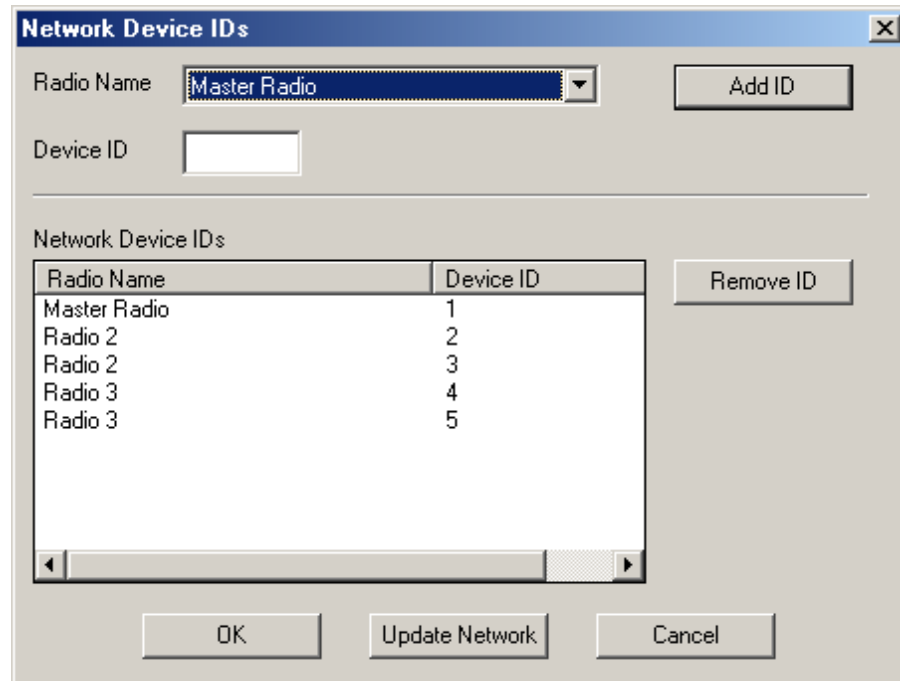

The dialog offers the following options:

- View the Device IDs – The Network Device IDs list shows each of the IDs that are currently associated with radios in the network.
- Adding an ID – To associate another ID with a radio, select the radio by name from the Radio Name list box, enter the new ID into the Device ID box and click the Add ID button. The new ID will be added to the list displayed below it.
- Removing an ID – To remove an ID, highlight the entry in the Network Device IDs list and click the Remove ID button. The entry will be removed from the displayed list.
- Updating the Radios – To update all the radios simultaneously with the (new) IDs, click the Update Network button. The program will then:
 - Communicate with the radio connected to the Configuration PC
 - Verify that all radios in the network are visible and can therefore be updated
 - Update radios with the IDs in the Network Device IDs list
 - Indicate which radios were and were not updated

Once the dialog closes, each of the radio configuration dialogs is updated with the entries from the list.

Modify Radio Settings

Existing radios contain elements that may be edited. To modify settings for an existing radio:

- (select the radio's icon)
- ▶ **Properties**
- ▶ **Radio**

OR

- Double-click the radio's icon

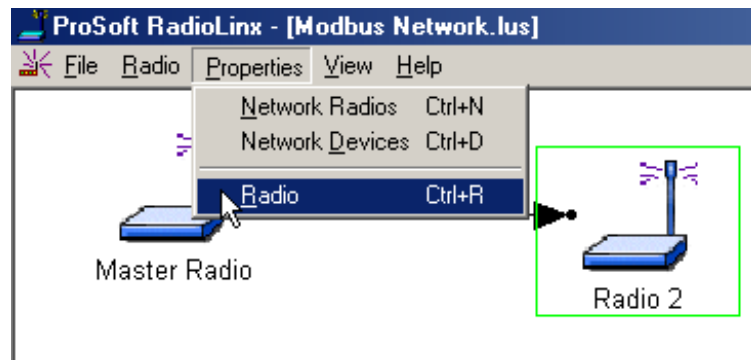

Each radio is a part of a specific type of network. Continue editing radio elements from the section appropriate to the specific kind of network of which the radio is a part:

- **Protocol Transparent Point-to-Point**
- **Protocol Transparent Broadcast**
- **Modbus RTU**
- **Modbus ASCII**
- **DNP**
- **RadioLinX OEM Protocol**
- **Dialup Modem Emulation**
- **Ethernet**

Change a Network's Properties

For Transparent, RadioLinx OEM, Dialup Modem Emulation and Ethernet Protocols, from the Graphical Layout Screen of an existing network, select:

- ▶ **Properties**
- ▶ **Network Radios**

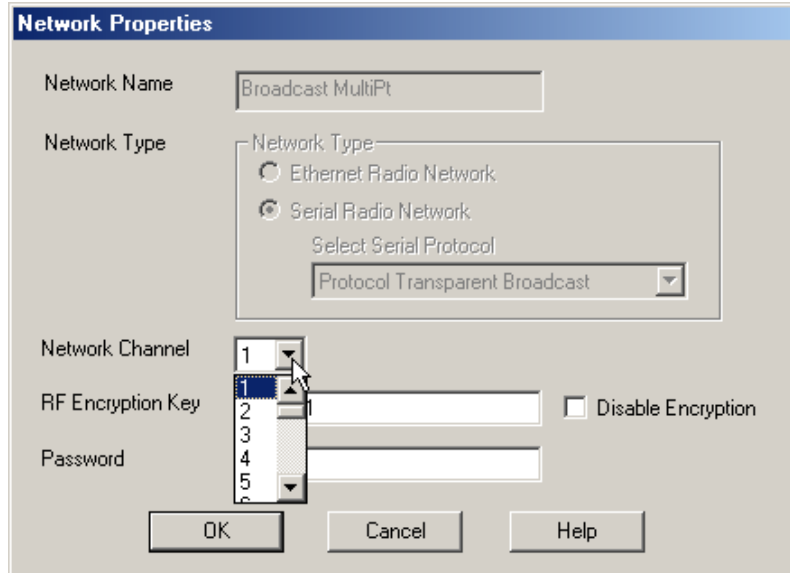
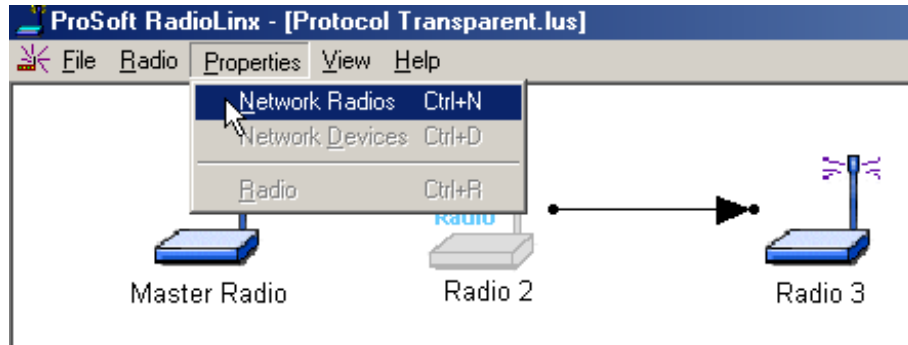

This screen allows the user to change the radio's Channel as well as RF Encryption settings and Password access to the RadioLinx configuration file.

- **Network Channel:** Select an unused Network Channel from the drop-down list.

- **RF Encryption Key:** The value entered in this field is translated into a 40-bit key used by the radios when encrypting packets sent over the air. The value entered must be between 5 and 7 characters. The allowable values are the alphanumeric characters 'a' through 'z' and '0' through '9'. The values are **case insensitive**.
- **Disable RF Encryption Check Box:** When this box is checked, radios will be programmed to not encrypt packets sent over the air. ProSoft Technology recommends that encryption is **not** disabled. In addition to providing security from intentional attempts to access your network, encryption prevents inadvertent access between two networks using the same channel number in the same geographical area.

NOTE:

All radios in a network must be programmed with the same encryption settings. If the encryption settings change, any radios that have been programmed already will need to be re-programmed with the new settings.

- **Configuration File Password:** The value entered into this field is used to restrict access to Network Configuration through the RadioLinx Setup and Diagnostics Software. Password protection of the configuration file prevents unwanted access to any configuration settings including the encryption key used. Once this value has been entered and confirmed in a subsequent screen, Network Configuration can be accessed only when the correct password is provided. If it is forgotten, a new Network will have to be defined.

The value entered must be between 5 and 7 characters. The allowable values are the alphanumeric characters 'a' through 'z' and '0' through '9'. The values are **case insensitive**.

If no password protection is desired, leave the field blank.

NOTE:

The **Network Name** and **Network Type** fields are "grayed-out" in this dialog box because the network parameters cannot be changed from here.

NOTE:

See When to Re-Configure Radios to ensure all radios will be updated.

Miscellaneous Options

Zoom View of Graphical Layout

Use the **Zoom** feature to customize the way the RadioLinX software displays graphical networks. **Zoom** is helpful when changing the screen view for greater clarity (smaller, larger, or custom area) or for overall global network comprehension (making it easier to move radio icons around).

- **Zoom In:** moves view to focus the graphical display closer to the user; radios look larger - less overall space is displayed
- **Zoom Out:** moves view farther away; radios look smaller - more overall space is displayed
- **Super Zoom:** custom view function; "zoom area", typically used when the graphical network covers more space than one default screen
- **Zoom To Fit:** changes view to match screen size; could be used to:
 - expand a small network to fill up the entire screen
 - contract an entire larger network to fit on one screen

Zoom In

Access the **Zoom** feature from the Graphical Layout Screen:

- ▶ **View**
- ▶ **Zoom In**

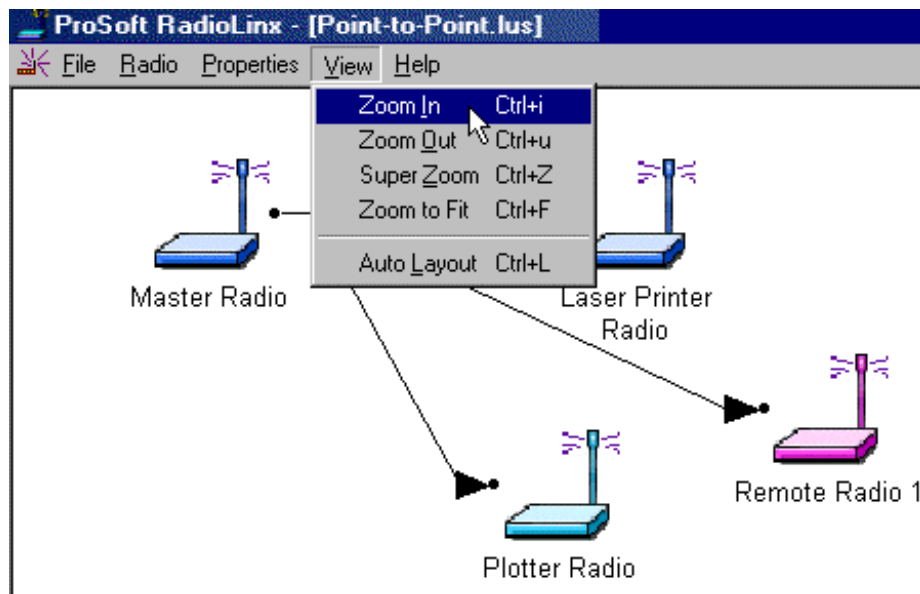

Before Zoom In

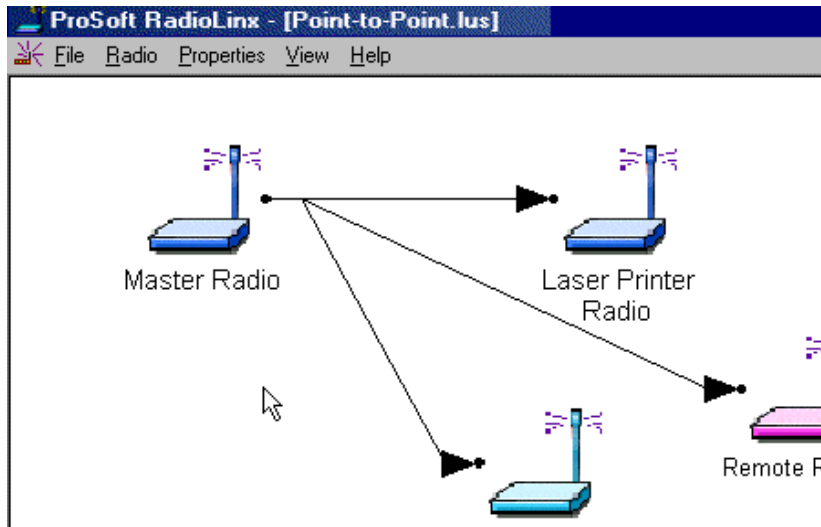

After Zoom In

Return to Zoom View of Graphical Layout for other **Zoom** commands.

Zoom Out

Access the **Zoom** feature from the Graphical Layout Screen:

- ▶ **View**
- ▶ **Zoom Out**

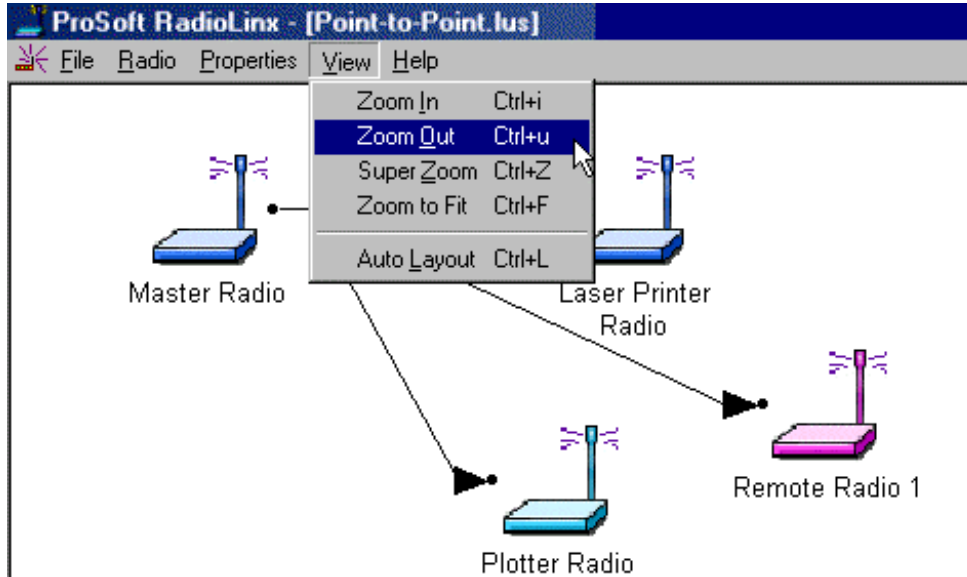

Before Zoom Out

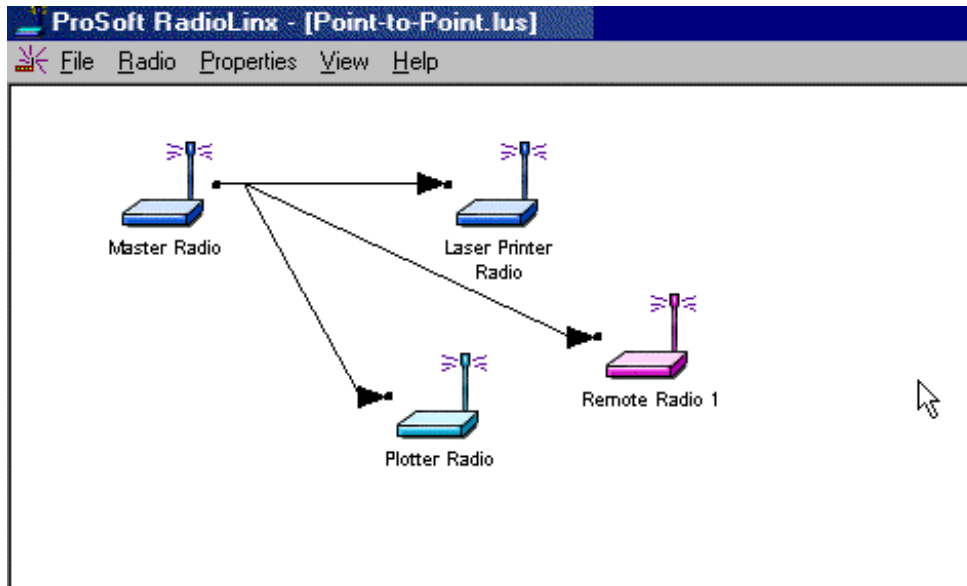

After Zoom Out

Return to Zoom View of Graphical Layout for other **Zoom** commands.

Super Zoom

Access the **Zoom** feature from the Graphical Layout Screen:

- ▶ **View**
- ▶ **Super Zoom**

Super Zoom is an enhanced way to customize the screen view. When **Super Zoom** is selected, the entire network is displayed with a dotted line box surrounding the space occupied by the default display.

When the cursor is moved from the area of the default display, the dotted line box becomes a solid line box and moves, following the placement of the cursor. To view a portion of the network more closely move the solid line box to cover the specific area. Once the box has been placed over the section of network to be viewed more closely, click the left mouse button. The box is "dropped" and the selected section of the network is "zoomed in" to the display.

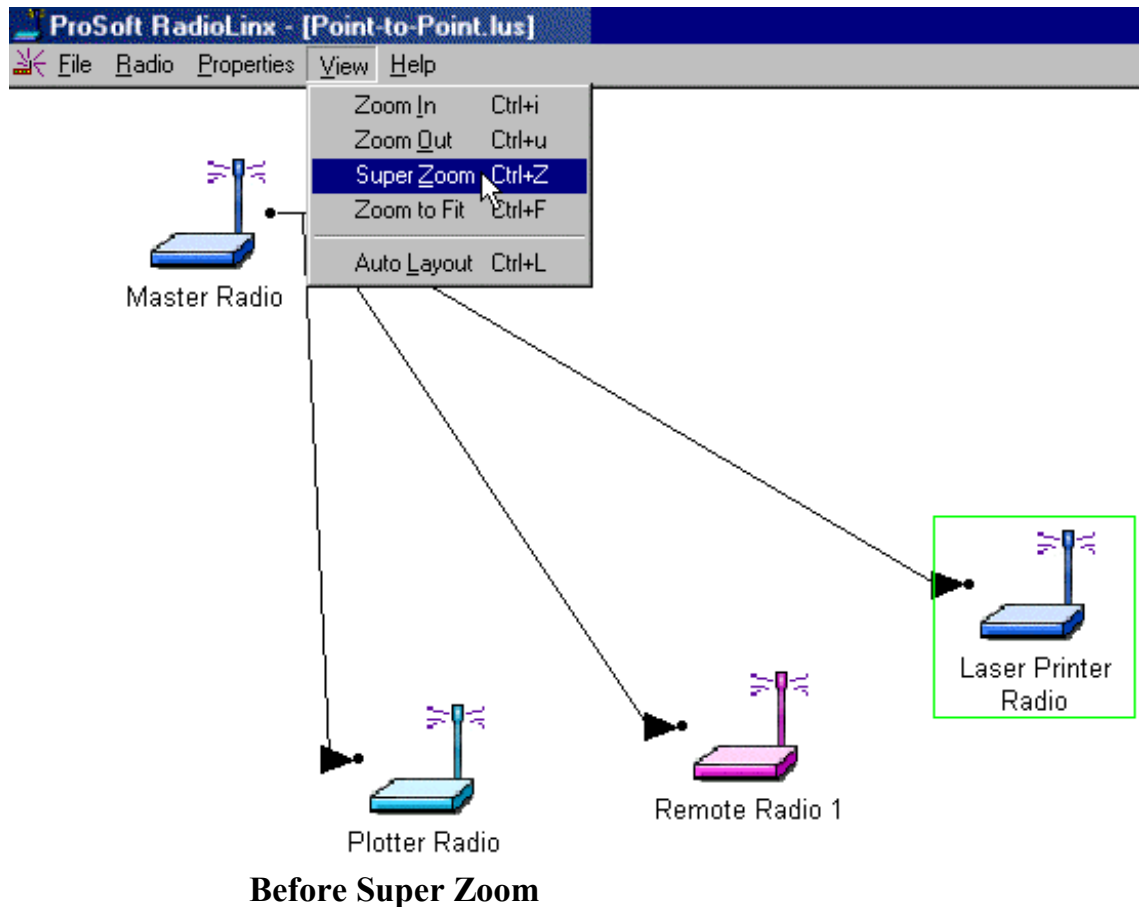

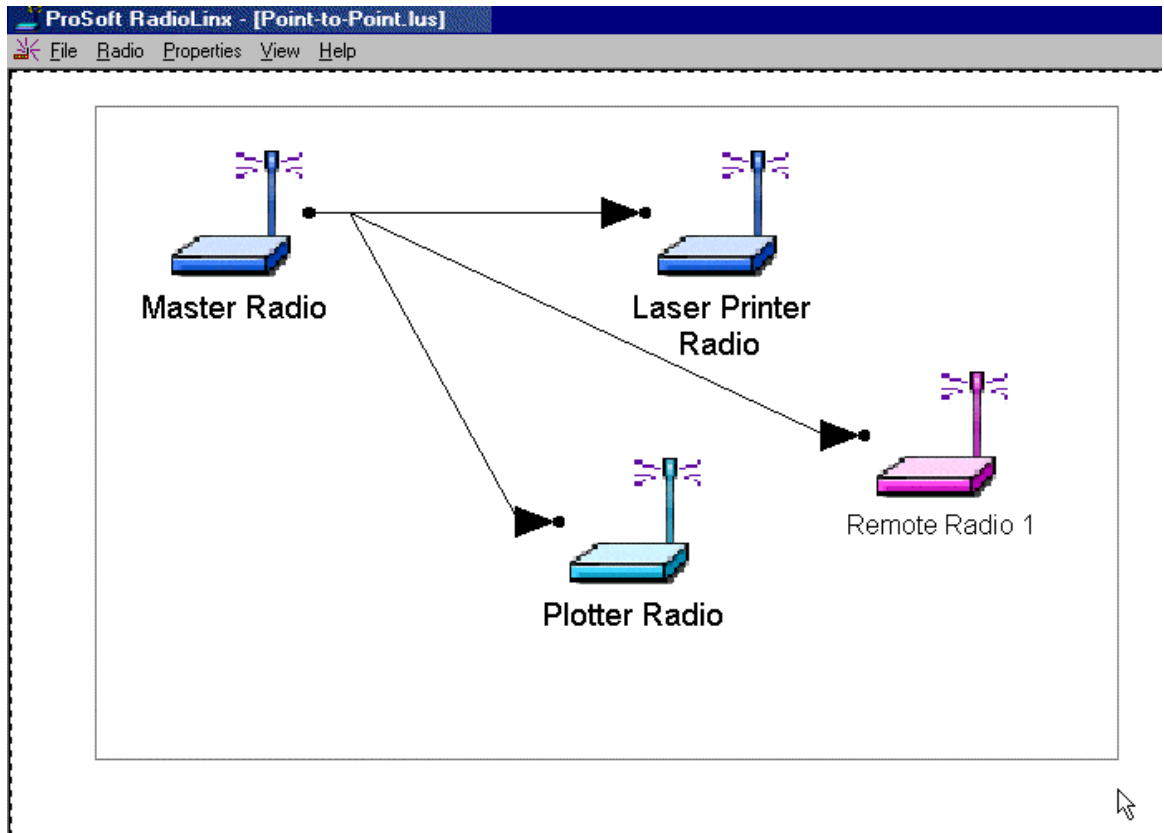

Drawing the box for close-up view

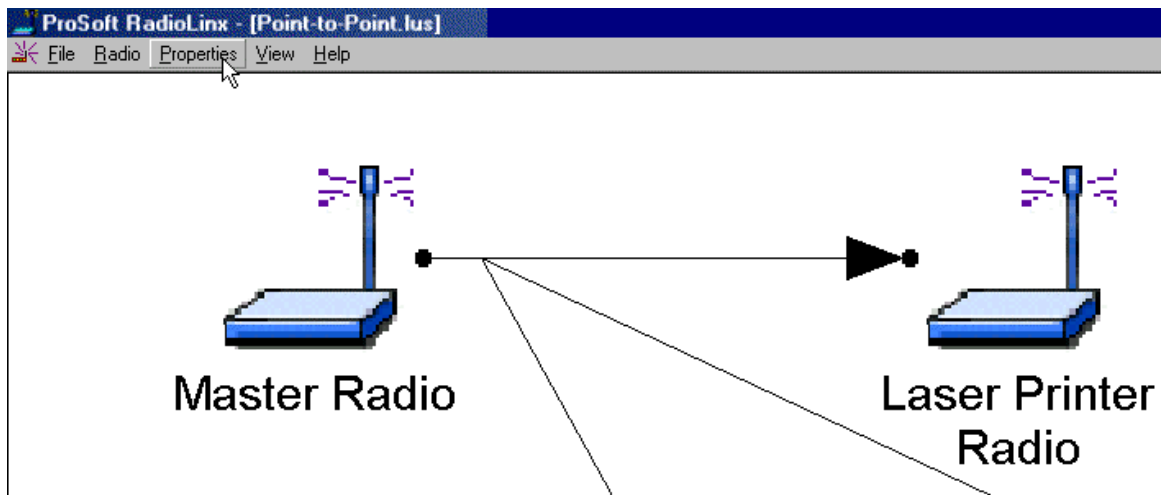

After Super Zoom

Return to Zoom View of Graphical Layout for other **Zoom** commands.

Zoom To Fit

Access the **Zoom** feature from the Graphical Layout Screen:

- ▶ **View**
- ▶ **Zoom to Fit**

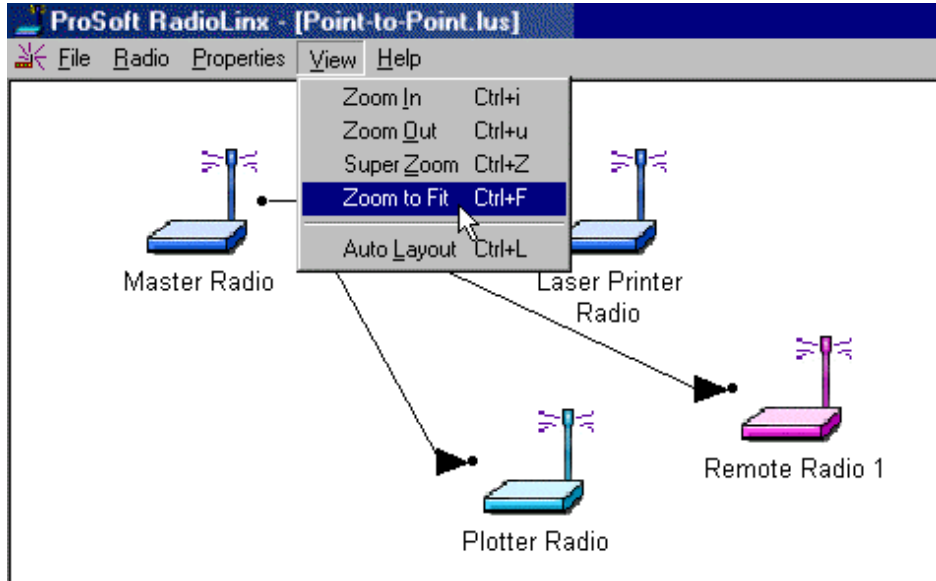

Before Zoom to Fit

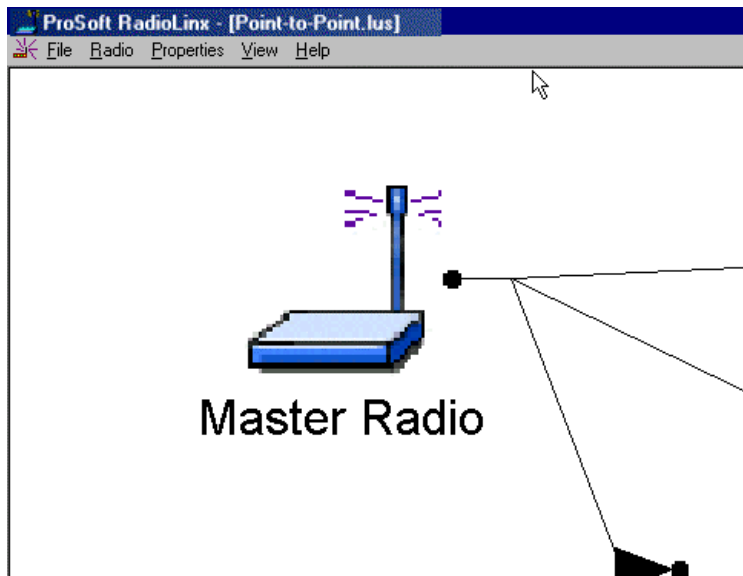

After Zoom to Fit

Return to Zoom View of Graphical Layout for other **Zoom** commands.

Upgrade Software - Download Code

The **Download Code** utility allows the user to upgrade the Serial and Ethernet radios' firmware when radio feature updates are implemented. Code updates can be obtained from Prosoft's website, www.prosoft-technology.com or by calling ProSoft Technology directly.

To start a code download, connect the radio to be upgraded to the Configuration PC's COM port as specified in the serial port configuration. From the RadioLinX Setup Application's **Main Menu**, select:

- ▶ **Utilities**
- ▶ **Download Code**

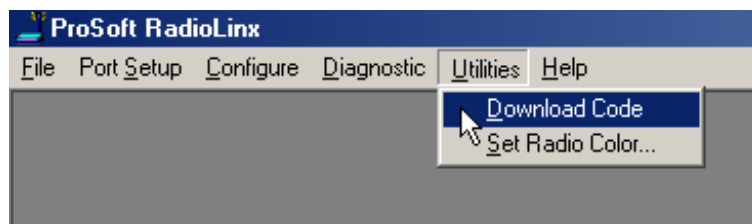

The download selection dialog box will then be displayed. Select the type of radio being updated. (If Ethernet Radio is selected, the Ethernet radio choices will be enabled. Only advanced users should select a Custom update.)

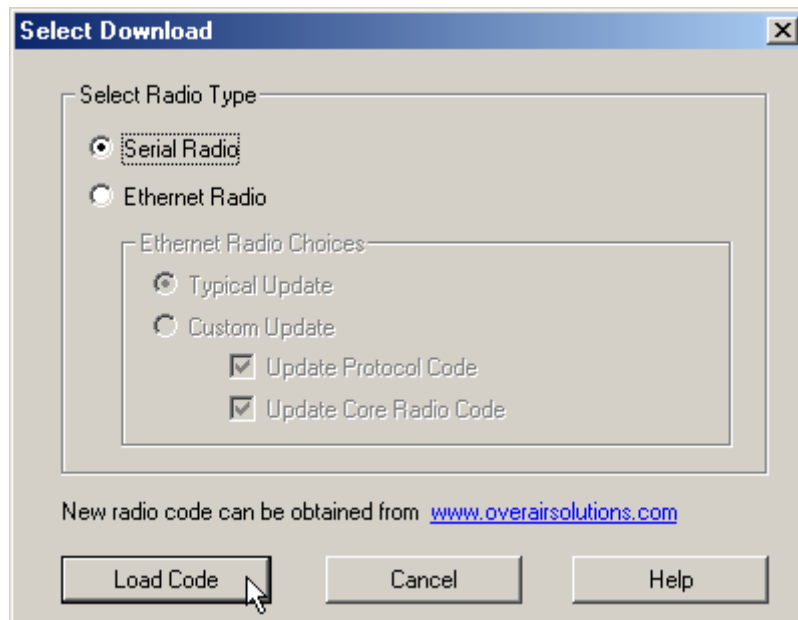

Once the correct selections are made, click the 'Download Code' button to begin the download. Status dialogs like the one below will be shown as the download progresses.

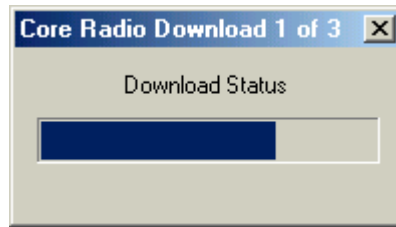

The following dialog will be shown once the code has been successfully downloaded.

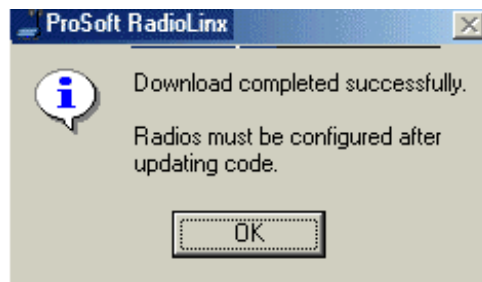

If a dialog like the one below is displayed, the files to be downloaded into the radio are not present.

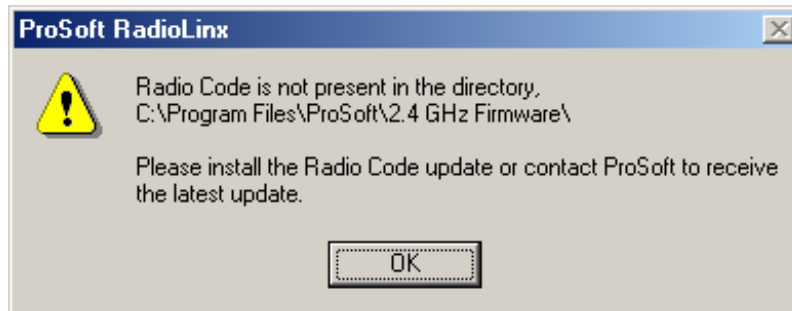

The files are not included with the RadioLinx Setup and Diagnostics Software. The installation updates can be obtained from ProSofts' website, www.prosoft-technology.com or by calling ProSoft Technology directly.

Diagnostics

Diagnostics Overview

Use the **Diagnostic** function to:

- **view** a graphical representation of the overall function of a network
- **query** an individual radio and **display** its operating parameters

The information obtained from the diagnostics function can be used to:

- **optimize** network function
- determine the source of failed communication

View Operating Network

To view a graphical representation of a network's communication links, connect a radio to the Configuration PC.

From the RadioLinx **Main Menu**, select:

- ▶ **Diagnostic**
- ▶ **Network**
- ▶ **the network by name** (from the displayed list of configured networks)

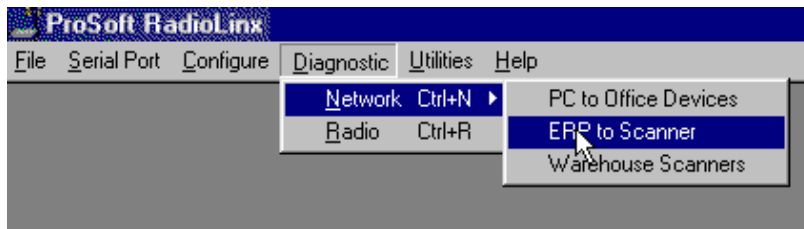

If an Ethernet Network, the following will display:

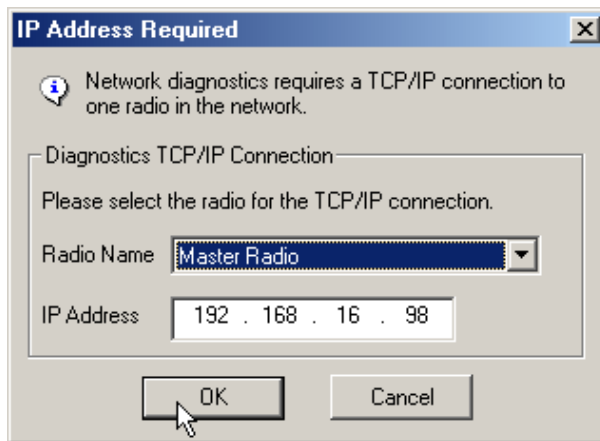

Select which radio is connected to the Configuration PC from the Radio Name drop down list. The IP Address of the radio connected to the configuration PC is automatically displayed.

Following is the RadioLinx's graphical representation of a **network with intact communication links**. The functioning RF communication link is represented solid colored lines.

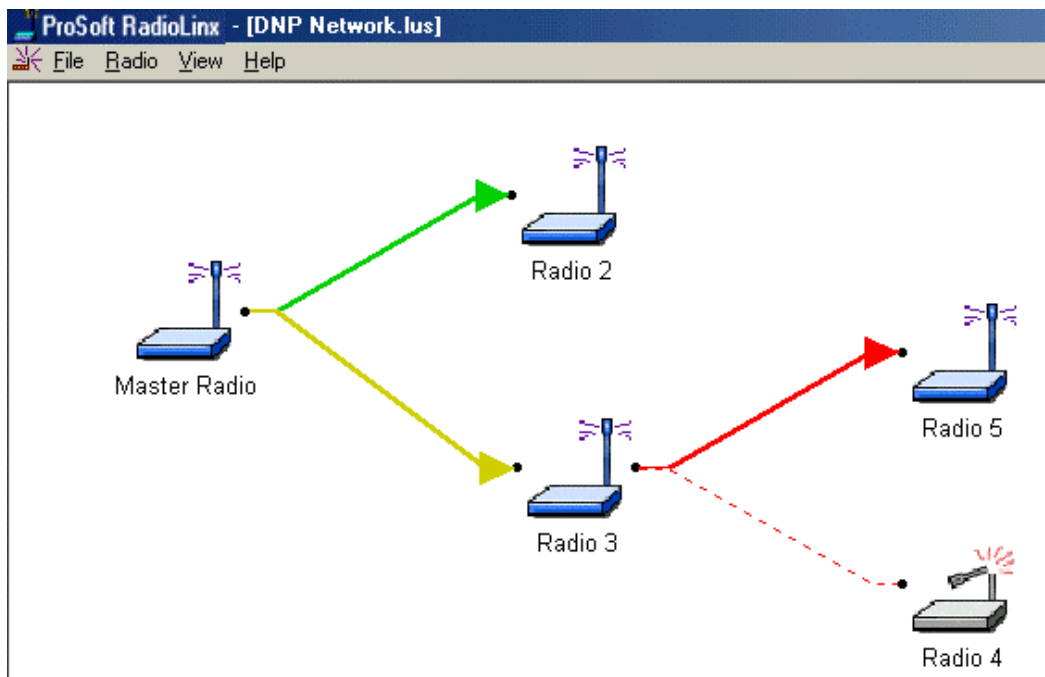

The colored lines indicate the signal strength of each radio, see Viewing Signal Strength. If any of the communication links show red dashed lines see Broken Links in a Radio Network.

Viewing Signal Strength

Once a network is configured, the Signal Strength of the Remote radios can be monitored. This is helpful when the radios are being physically installed.

To monitor the Remote radio's Signal strength:

From the RadioLinx **Main Menu**, select:

- ▶ **Diagnostics**
- ▶ **Network**
- ▶ **the network by name** (from the displayed list of configured networks)

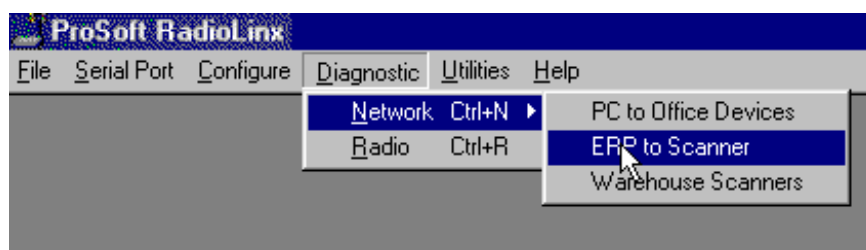

Once the network is displayed, double click the remote radio to be monitored. The following dialog box will appear:

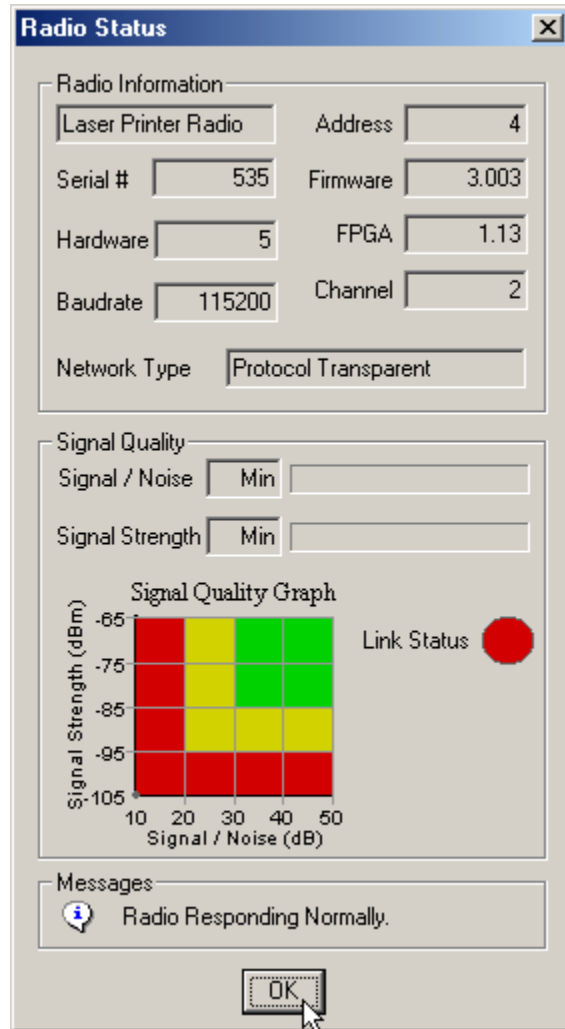

NOTE: An ethernet radio must be monitored with an ethernet connection. see VIEW OPERATION NETWORK for details.

Broken Links in a Radio Network

To view the communication link any radio can be cabled to the Configuration PC for network diagnostics.

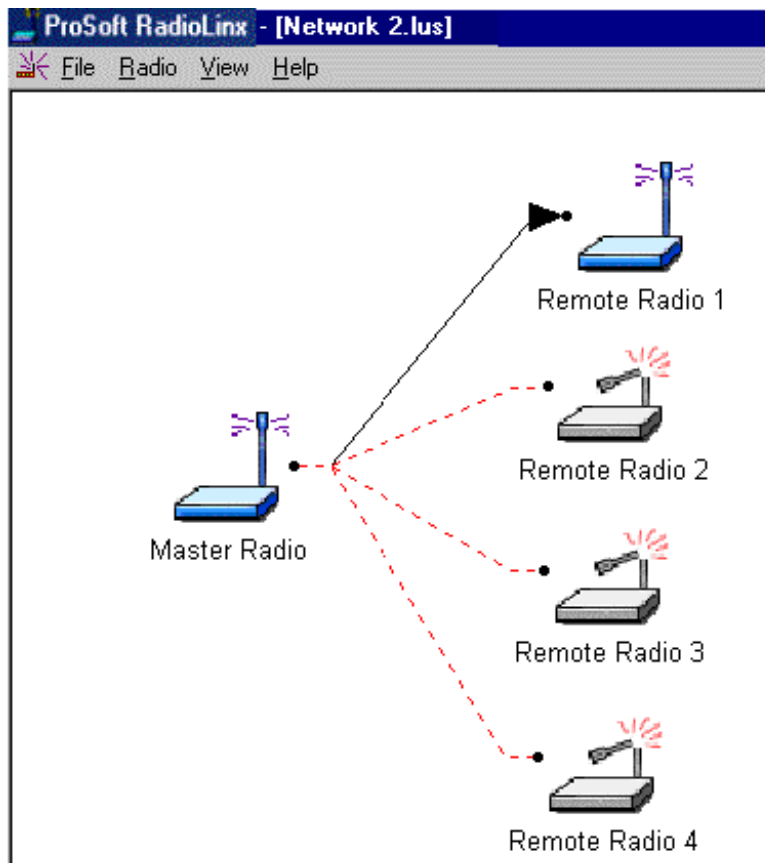

If radios do not communicate, investigate some of the sources of error.

Query a Radio Directly

A radio can be queried so that it reports its settings to the Configuration PC. Radios may be queried **directly** (through a cable connected to the Configuration PC) or remotely (through communication with the Master radio cabled to the Configuration PC). If necessary, check the serial port settings to determine which COM port is configured for the RadioLinx network.

To directly query a radio (either Master or Remote), cable the radio to the Configuration PC. From the RadioLinx Setup/Application **Main Menu**, select:

- ▶ **Diagnostic**
- ▶ **Radio**

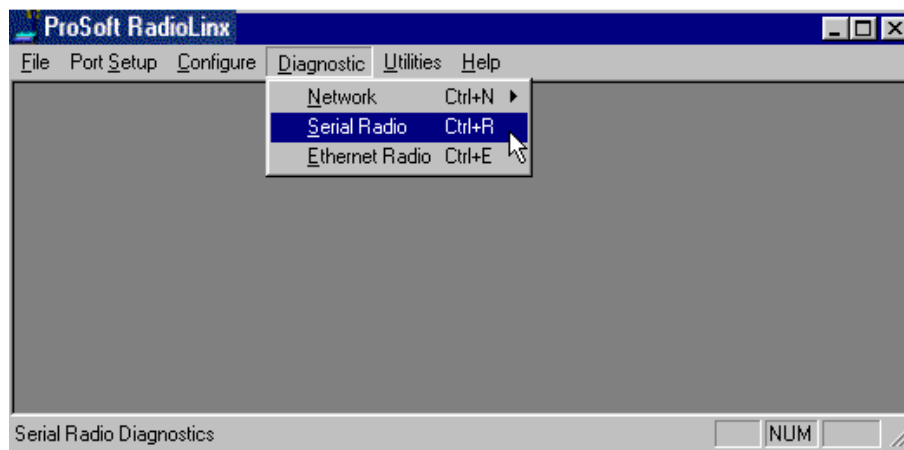

The Radio Parameters dialog box appears. Click the **Get Data** button to receive data.

For Serial Radios:

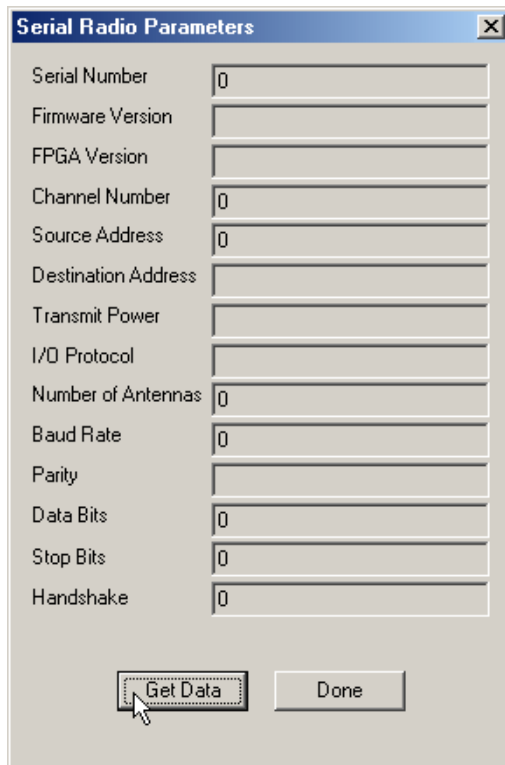

The image shows a dialog box titled "Serial Radio Parameters" with a close button (X) in the top right corner. It contains a list of parameters, each with a text input field. The "Serial Number" field contains the value "0". The other fields are empty. At the bottom, there are two buttons: "Get Data" and "Done". A mouse cursor is pointing at the "Get Data" button.

Serial Number	0
Firmware Version	
FPGA Version	
Channel Number	0
Source Address	0
Destination Address	
Transmit Power	
I/O Protocol	
Number of Antennas	0
Baud Rate	0
Parity	
Data Bits	0
Stop Bits	0
Handshake	0

Radio Parameter dialog BEFORE getting data

For Ethernet Radios:

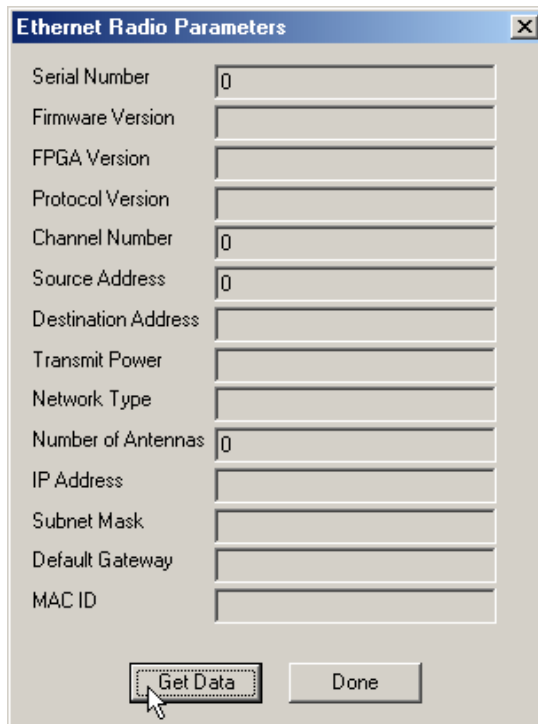

The image shows a dialog box titled "Ethernet Radio Parameters" with a close button (X) in the top right corner. It contains a list of parameters, each with a text input field. The "Serial Number" and "Channel Number" fields contain the value "0". The other fields are empty. At the bottom, there are two buttons: "Get Data" and "Done". A mouse cursor is pointing at the "Get Data" button.

Serial Number	0
Firmware Version	
FPGA Version	
Protocol Version	
Channel Number	0
Source Address	0
Destination Address	
Transmit Power	
Network Type	
Number of Antennas	0
IP Address	
Subnet Mask	
Default Gateway	
MAC ID	

Radio Parameter dialog BEFORE getting data

This is an example of the settings a radio will report:

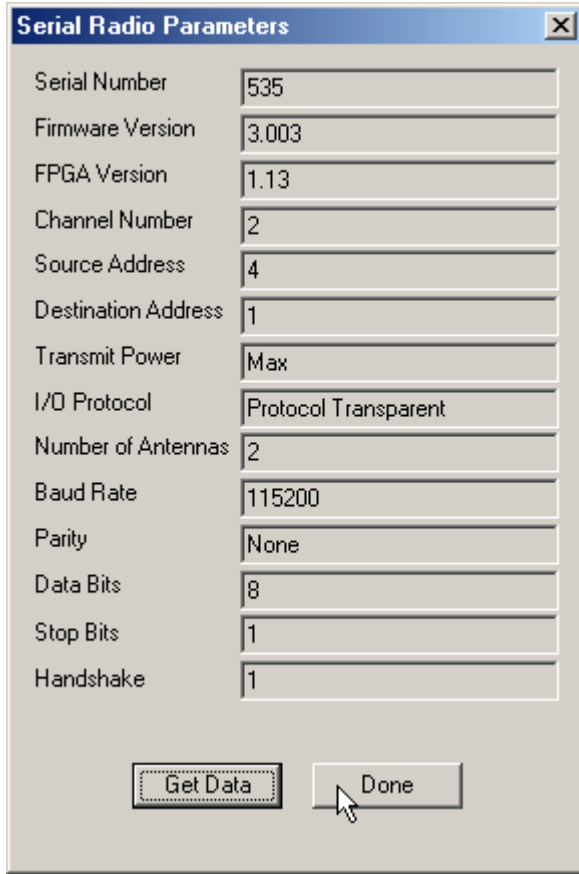

The image shows a dialog box titled "Serial Radio Parameters" with a close button (X) in the top right corner. The dialog contains a list of parameters, each with a text input field:

Serial Number	535
Firmware Version	3.003
FPGA Version	1.13
Channel Number	2
Source Address	4
Destination Address	1
Transmit Power	Max
I/O Protocol	Protocol Transparent
Number of Antennas	2
Baud Rate	115200
Parity	None
Data Bits	8
Stop Bits	1
Handshake	1

At the bottom of the dialog, there are two buttons: "Get Data" and "Done". A mouse cursor is pointing at the "Done" button.

Radio Parameter dialog AFTER getting data

Select the **Get Data** button to retrieve data from the radio cabled to the COM port. Generally, a radio is queried if there is a network failure. (An error dialog box will appear if there is no communication between the cabled radio and the Configuration PC.)

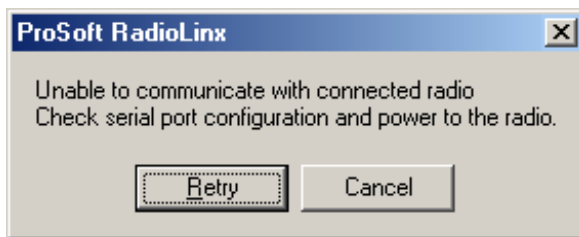

The image shows an error dialog box titled "ProSoft RadioLinx" with a close button (X) in the top right corner. The dialog contains the following text:

Unable to communicate with connected radio
Check serial port configuration and power to the radio.

At the bottom of the dialog, there are two buttons: "Retry" and "Cancel".

Select the **Done** button to close the **Radio Parameters** dialog box.

Query a Radio Remotely

A radio can be queried so that it reports its settings to the Configuration PC. Radios may be queried **remotely** (through communication with the Master radio cabled to the Configuration PC) or directly (through a cable connected to the Configuration PC) so that it reports its settings to the Configuration PC. (If necessary, check the serial port settings to determine which COM port is configured for the RadioLinx network.)

NOTE:

If contacting the Manufacturer for technical support, ProSoft Technology Support will ask for:

- the radio's serial number
- software (firmware) revision information
- hardware revision information

Revision information is available by querying radios through the **Diagnostic** menu.

To remotely query a radio, cable the Master radio to the Configuration PC. From the RadioLinx Setup/Application **Main Menu**, select:

- ▶ **Diagnostic**
- ▶ **Network**
- ▶ **the network, by name** (as shown)

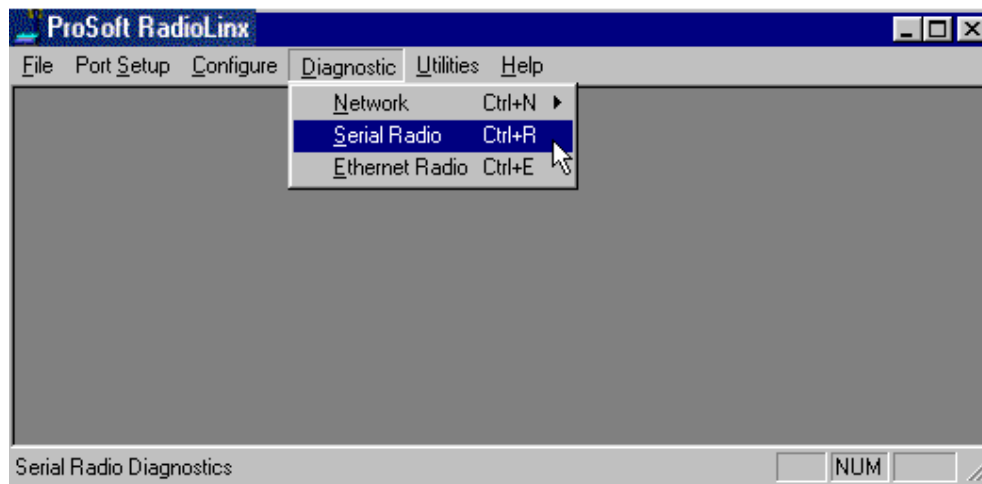

From the **Diagnostic Network Menu**, select the Remote radio's icon, then:

- ▶ **Radio**
- ▶ **Properties**

OR

Double-click the radio's icon

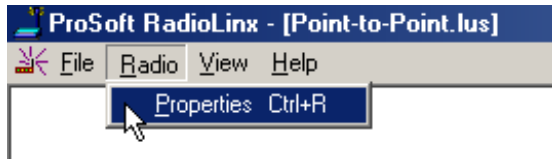

The **Radio Status** dialog box displays the following fields and parameters:

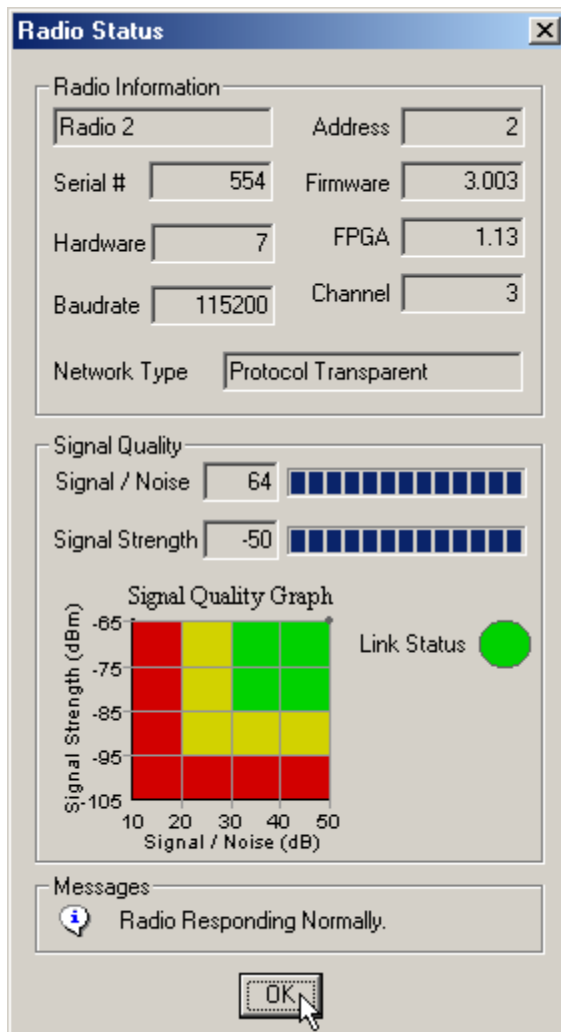

- **Radio Name:** as defined during network configuration.
- **Address:** the radio's address as automatically set during network configuration.
- **Serial #:** the radio's serial number as programmed by the manufacturer.
- **Firmware:** the version number of the software code embedded in the radio.
- **Hardware:** the version number of the radio's hardware.

- **FPGA:** the version number of the Field Programmable Gate Array logic in the radio. This logic determines the hardware characteristics of the radio.
- **Baudrate:** the baud rate of the radio's serial port as set during radio configuration.
- **Channel:** the channel of the network of which the radio is a component.
- **Network Type:** as set during network configuration.
- **Signal Quality:** parameters that indicate how well the network is operating. **The Remote radio** calculates the strength (Signal Strength) of the signal from the Master. It also calculates the strength of the background noise (interference). The Signal-to-Noise value is the ratio of Signal-Strength to Noise-Strength. Monitoring how this value changes when antennas are moved during installation verification can ensure that the installation configuration has been optimized. For optimum network performance, the larger the Signal-to-Noise ratio, the better. The Signal Quality Graph is a color coated grid to more precisely display the Signal-to-Noise ratio and aide in installation verification.
- **Messages:** indicates if the radio is responding or not.

NOTE: THE MASTER RADIO STATUS BOX DOES NOT INCLUDE SIGNAL QUALITY PARAMETERS.

The image shows a 'Dialog' window titled 'Radio Information' with a close button (X) in the top right corner. The window contains several input fields for radio configuration:

Master Radio	Address	1	
Serial #	303	Firmware	2.000
Hardware	-2	FPGA	1.01
Baudrate	115200	Channel	14
Network Type	Point to Point		

At the bottom center of the dialog is an 'OK' button.

Test the Network Installation Plan

Test proposed installations before the installation is finalized.

Once the network has been configured and the radios have been configured:

- install the Master radio in its proposed permanent location
- cable the Configuration PC to the Master radio
- place the Remote radios in their proposed locations
- temporarily place each radio's antenna near its proposed mounting location. The temporary placement of the antenna can be by hand, however, with this testing method, one person must hold the antenna while another monitors the Remote radio's signal strength as displayed on the Configuration PC.

To improve the signal quality of each Remote's communication:

- increase the height of the antenna's placement
- use higher-gain antennas
- increase the radio's transmission power, cable the radio to the Configuration PC, and reconfigure it
- select a new location for the Remote radio and/or its antenna
- decrease the length of antenna cable
- determine and resolve sources of "electrical" noise which may be interfering with the RadioLinux transmission
- add a repeater between the radios that are not communicating or reconfigure an existing radio as a repeater if line of sight is available

NOTE:

SEE WHEN TO RE-CONFIGURE RADIOS TO ENSURE ALL RADIOS ARE UPDATED.

Troubleshooting

Troubleshooting Overview

Following is a Troubleshooting guide to address specific situations:

- Auto Detection Sequence
- Cannot configure a radio
- Radios do not communicate
- Contact the manufacturer

Automatic Serial Port Check

The RadioLinX diagnostic function will attempt to communicate with the radio using all available serial port parameters if the **Auto Detection Sequence** is invoked. The auto detection sequence is **very** time consuming due to the multitude of serial port parameters and available combinations. If the correct serial port parameters are known for a particular radio, set the Configuration PC's serial port to match those of the radio and do not rely on the Auto Detect Sequencing process to reset the radio. Once communication is reestablished, the radio can be reconfigured as required for your specific requirements.

NOTE:

New serial port settings become current after the radio is reset or power-cycled.

Cannot Configure a Radio

If the following error dialog message appears during **Configure Radio**, check that:

- there is power to the radio
- the radio's green POWER LED light is lit

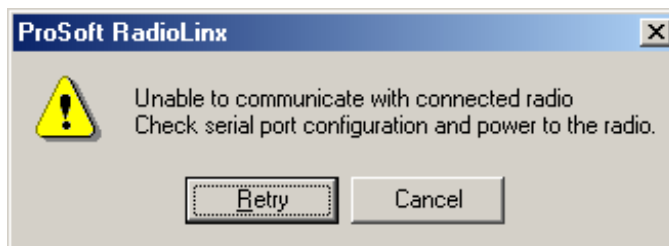

If the power connection to the radio is intact, compare the radio's serial port settings to those of the Configuration PC's serial port.

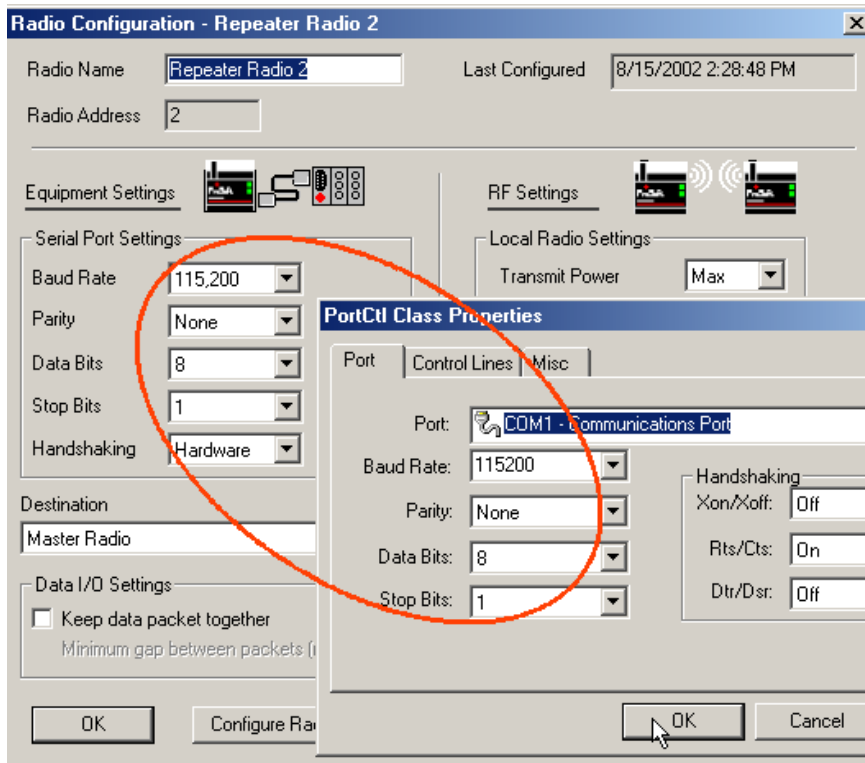

If the following error dialog box is displayed, another application may be using the same COM serial port as assigned to the RadioLinx Setup/Diagnostic Application. Only one application can use the same COM port at a time. Close any applications that may be using this COM port (including duplicate instances of the RadioLinx Setup/Diagnostics Application).

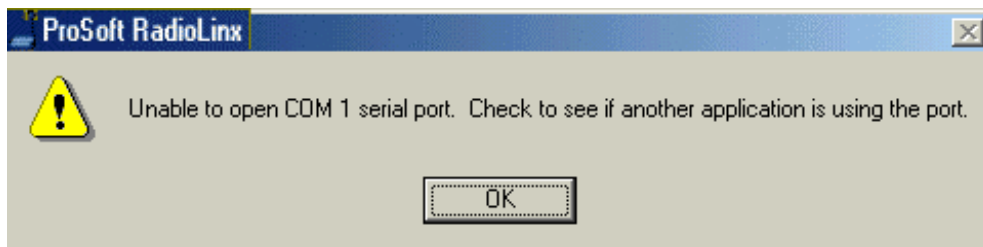

Radios do not communicate

The following list can be used to troubleshoot a non-communicating network:

- **Problem – There is no power light**

Corrective Action - Check that each radio is powered.

- **Problem - Radio does not appear to communicate.**

Radios do not appear to communicate (could be either the Master radio or a Remote radio)

Corrective Action - Power-cycle the radio.

- **Problem - The Serial Port Settings of the Configuration PC are not the same as those of the radio cabled to it.**

If the serial port settings are not the same there can be no communication between the two devices.

Corrective Action – Check the serial port settings to restore communication.

- View the radio's serial port settings
- Set the Configuration PC's COM port settings

There are two error messages. Following are the messages and the appropriate action.

- 1) Error message questions whether the DC power connection to the radio is intact as shown below.

Check the power to the radio and click the Retry button.

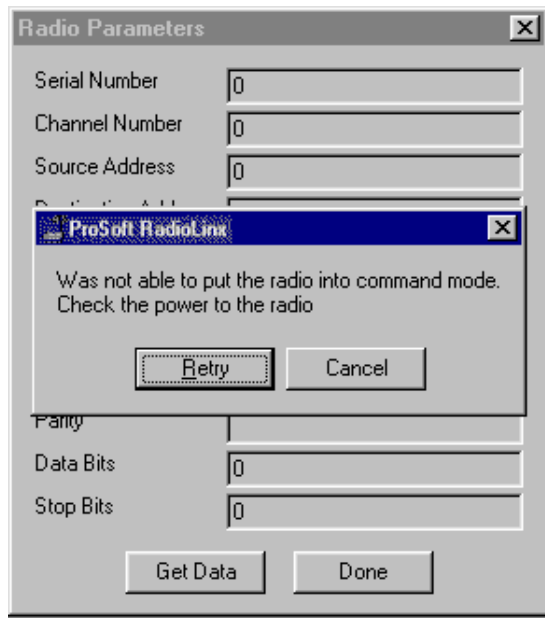

- 2) The second error message (as shown below) occurs only if there is **still** no communication between the devices. After clicking the **Retry** button, the RadioLink diagnostic function will suggest an auto detection sequence. [Note: this process is frequently very time-consuming (up to 20 minutes)]. Select **Yes** or **No** depending on whether you wish to attempt the auto detection sequence.

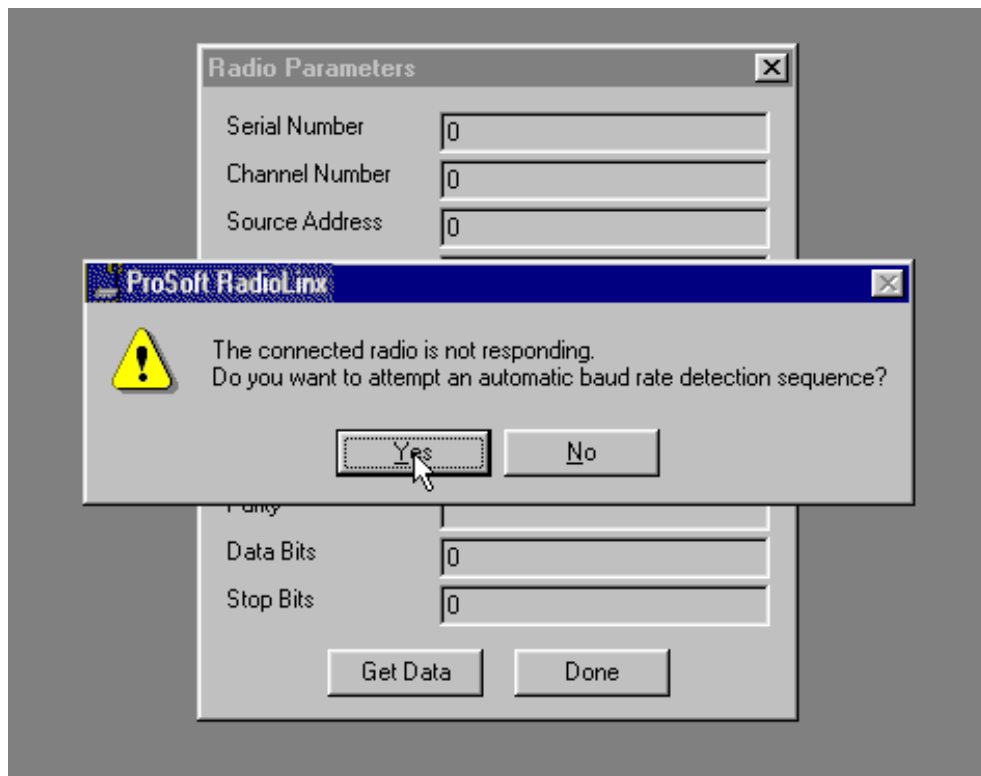

- **Problem - Radio is in "Download code" mode:**

If the cause of the problem is that the radio is in **Download code** mode, the diagnostic LEDs on the radio will flash in the following sequence:

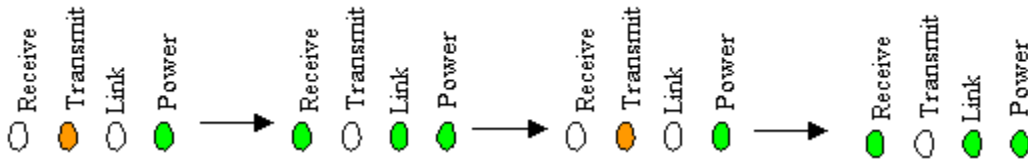

Corrective Action – Reload software from the **Download Code** CD.

- **Problem – Radios do not have correct radio parameters**

The radio parameters need to be updated. The RadioLinx Setup/Diagnostic Application keeps track of all network and radio configurations in a database embedded in its software on the Configuration PC. If there is a mismatch between the parameters in the database and those embedded in the radio, network function may fail.

Corrective Action - Correct the parameter mismatch between the Configuration PC and the radio itself:

- print the network's configuration from the Configuration PC's **Configure** screen
- query the network's radios directly or remotely

The channel, source address, and destination address values **must match** between the radio and the Configuration PC. If they do not, reconfigure the radio(s) to correct the mismatch.

- **Problem – Modbus device/ remote radio does not communicate to the Master radio via modbus device/remote radio**

Corrective Action – Make sure that all of the Modbus remote radios are configured before configuring the master radio.

- A remote Modbus radio device needs to be configured with the appropriate Modbus ID before it is added to the Modbus network
- Re-configure the Master radio in the network so that they new remote radio and device ID parameter may be loaded into the Master radio.

NOTE:

Check the ProSoft Technology website for answers to Frequently Asked Questions (FAQ).

Contact the Manufacturer

Contact ProSoft Technology for your RadioLinx.

It is possible to get in touch with the Manufacturer for technical support. Before contacting the manufacturer, please query the appropriate radio(s) -- either directly or remotely -- and have the following information ready:

- the radio's serial #
- firmware version
- hardware version
- FPGA version

ProSoft Technology

1675 Chester Avenue

Bakersfield, CA 93301

USA

Phone: 661/716-5100

Fax: 661/716-5101

Website: www.prosoft-technology.com

Reference Information

Serial Port Basics

PC communications depend primarily on serial and parallel ports to interface the PC to the outside world. A "port" is a connection or plug-in that gives access to the PC. The port allows the computer to communicate with devices such as printers, input devices (serial mouse), and modems.

The serial port is more difficult to interface to than the parallel port because most serial devices require that the serial transmission is characters are converted into a parallel format. This conversion is accomplished with a communications controller chip, (UART – Universal Asynchronous Receiver/Transmitter).

Two common serial interface standards are RS-232 and RS-485. The RS-232 protocol is an industry standard protocol while the RS-485 protocol is commonly used in the industrial automation market.

There are two types of devices to which a serial-cabled device can communicate:

- DCE (Data Communications Equipment) - modem, plotter.
- DTE (Data Terminal Equipment) - PC or terminal

Serial ports have two common connector styles:

- DB25 pin connector
- DB 9 pin connector

Today's typical PC comes equipped with one parallel port and two DTE serial ports (both are male connectors). To connect two DTE devices to each other, the easiest (and recommended) connection method is with a Null Modem cable (female connectors on each end). This is commonly used as a quick and inexpensive way to transfer files between two PCs without having to install a dedicated network card in each PC.

Note: The RadioLinx Wireless Modems and Switches are DCE devices.

The following table contains the pin functions for both the DB25 and the DB9 connectors:

Pin Name	Pin Number DB9 / DB25	Function
Transmit Data (TXD)	Pin 3 / 2	Serial Data Output
Receive Data (RXD)	Pin 2 / 3	Serial Data Input
Clear-To-Send (CTS)	Pin 7 / 4	This line indicates that the modem is ready to exchange data.
Data-Carrier-Detect (DCD)	Pin 1 / 8	This line becomes active when the modem detects a carrier from the modem on the other end of the phone line.
Data-Set-Ready (DSR)	Pin 6 / 6	This tells the UART that the modem is ready to establish a link.
Data-Terminal-Ready (DTR)	Pin 4 / 20	This tells the modem that the UART is ready to exchange data.

Request –To –Send (RTS)	Pin 7 / 4	This line informs the modem that the UART is ready to exchange data.
Ring Indicator (RI)	Pin 9 / 22	Goes active when modem detects a ringing signal
Signal Ground (SG)	Pin 5 / 7	Signal ground

Communication signals diminish in strength as they travel through cable. The maximum cable lengths for RS-232 are less than RS-485 because the RS-232 interface is more susceptible to noise. The data performance of RS-232 and RS-485 is similar as long as the cable requirements are met. The following table gives an estimation of the cable length requirements for the two serial interface protocols:

Characteristic	RS-232	RS-485
Maximum cable length	100 feet	4000 feet
Maximum bits/sec.	20kb/s	10Mb/s

There are different ways to transfer data serially; simplex, half-duplex, and full-duplex. **Simplex** communication mode allows transmission of data in one direction only. In the **half-duplex** mode, data can be transferred in both directions, but not simultaneously. That means data can be transferred over a single pair of wires, but the data can only be transferred in one direction at a time. **Full-duplex** mode utilizes two pairs of wires and the data can be transferred in both directions simultaneously.

Glossary

ASCII: American Standard Code for Information Interchange; a Modbus communication mode. In ASCII mode, each eight-bit byte in a message is sent as two ASCII characters. The main advantage of this mode is that it allows time intervals of up to one second to occur between characters without causing an error. (See also RTU mode, below.)

Configuration PC: A Computer that contains the RadioLinx Setup/Diagnostic software

dB_i: Decibels referenced to an "ideal" isotropic radiator in free space; frequently used to express antenna gain

dB_m: Decibels referenced to one milliwatt (mW); an "absolute" unit used to measure signal power (transmit power output or received signal strength)

DCE: Data communications equipment. For example, a modem.

Decibel (dB): A measure of the ratio between two signal levels; used to express gain (or loss) in a system.

Default Gateway: The default network that the Configuration PC will operate on. The gateway is the computer that routes the traffic from a workstation to the outside network.

DTE: Data Terminal Equipment, for example, a computer or terminal.

effective isotropically radiated power (e.i.r.p.): The arithmetic product of the power supplied to an antenna and its gain.

firmware: Firmware is the embedded software code that is in the radio to direct radio function (similar to the BIOS in a personal computer). This is distinguished from the Setup/Diagnostic Application software that is installed on the Configuration PC.

frequency hopping: A radio that rapidly changes its operating frequency several times per second following a pre-determined sequence of frequencies. The transmitting and receiving radios are programmed to follow the same frequency hopping sequence.

full-duplex: Simultaneous two-way independent transmission in both directions

half-duplex: A circuit designed for transmission in either direction but not both directions simultaneously.

IP Address: An identifier for a computer or device in a TCP/IP network. Networks using the TCP/IP Protocol route messages based on the IP address of the destination. The format of an IP address is a 32-bit numeric address written as four numbers separated by periods. Each number can be zero to 255. For example, 1.160.10.240 could be an IP address.

Link point: The graphical point next to a radio icon that represents the connection point for RF communications between radios. An RF connection between two radios is called an RF Link and is represented as a graphical black line between the radio's link points.

Mac ID: A unique hex-number that identifies any Ethernet device.

Master device: Device that is connected to the Master radio.

Modbus: The ModBus protocol provides the internal standard that the MODICON controllers use for parsing messages. During communications on a ModBus network, the protocol determines how each controller will know its device address, recognize a message addressed to it, determine the kind of action to be taken, and extract any data or other information contained in the message. If a reply is required, the controller will construct the reply message and send it using ModBus protocol.

modem: Stands for MODulator-DEModulator, a device that converts digital signals to analog signals and vice-versa.

Analog signals can be transmitted over communications links such as telephone lines.

null modem cable: A specialty cross-communication cable with female connectors on each end used for direct connection between devices when no modems are present. Commonly used as a quick and inexpensive way to transfer files between two PCs without installing a dedicated network card in each PC.

Peer-to-Peer Network: Each radio in a Peer-to-Peer network has the ability to receive data from -- and transmit data to -- any other radio in the network.

Point-to-Point Network: A network consisting of a single Master radio and a single Remote radio. All data from the Master is received and acknowledged by one Remote. All data from the single Remote is received and acknowledged by the Master radio.

Point-Multipoint (Broadcast) Network: A network type where a single master radio sends data to every remote radio in the network. This is done repeatedly until every remote radio individually receives and acknowledges the data. Each remote radio sends pending data to the master radio that receives and acknowledges data sent from each remote. In this configuration, there are multiple remote radios referenced to a single master radio.

Point-Multipoint (Modbus) Network: A network with a single Master radio and multiple Remote radios. The devices cabled to the radios communicate through the Modbus standard protocol. The Master radio sends data to a Remote radio based on the Modbus address of the Modbus device. The data is only sent to the single Remote device based on its address. Each Remote radio sends its data only to the Master radio. The Master and Remote radios acknowledge that data was received correctly.

poll: A method of electronic communication.

protocol: Rules that define how two or more communications devices will "talk" to each other.

Remote device: Devices connected remote radios

RTU (Remote Terminal Unit): Modbus transmission mode where each eight-bit byte in a message contains two four-bit hexadecimal characters. There are two transmission modes (ASCII or RTU). The main advantage of the RTU mode is that its greater character density allows better data throughput than ASCII mode for the same baud rate; each message is transmitted in a continuous stream. (See also ASCII, above.)

simplex: A circuit capable of operating in only one direction.

spread spectrum: A technique where a narrow-band signal is spread over a broader portion of the radio frequency band.

Subnet Mask: A mask used to determine what subnet an IP address belongs to. An IP address has two components, the network address and the host address. For example, consider the IP address 150.215.017.009. Assuming this is part of a Class B network, the first two numbers (150.215) represent the Class B network address, and the second two numbers (017.009) identify a particular host on this network.

UART: Universal Asynchronous Receiver/Transmitter

Index

A

Adding Radios for Point Multipoint.....	62
Adding Repeaters to a Network	63
Antenna Diversity	38
Antenna Gain	28
Antenna Installation Overview	36
Antenna Location Spacing and Mounting.....	39
Antenna Pattern.....	28
Antenna Polarity.....	29
Antenna Selection	30
Antenna Spacing Requirements - User Safety	10
Antenna Types Overview.....	30
Approved Antennas.....	34
Assigning Device IDs Network Wide	91
Automatic Arranging of Network Icons.....	66
Automatic Serial Port Check.....	116

B

Broken Links in Point-Multipoint Network	108
--	-----

C

Cable Specifications Cross-Over or Straight-Thru.....	42
Change a Network's Channel	94
Change a Radio's Type	69
Collinear Array Antenna	31
Configure a New Network	56
Configuring Your Serial Port.....	43
Connecting Antennas	36
Contact the Manufacturer.....	121

D

Define Name Type Channel.....	56
Delete a Radio.....	70
Dialup Modem Emulation Network	23
DTE.....	124

E

Establish the Graphical Communication Link between Radios	65
Ethernet	24
Ethernet Addressing Overview	48
Ethernet Start.....	47
European CE Certification	9

F

FCC Compliance Statement.....	6
Functional Conventions	13

G

Gain / User Proximity to Antenna.....	34
---------------------------------------	----

General Radio Configuration	77
Glossary	124
Graphical Layout Screen.....	61
I	
Installation Overview	25
M	
Master Antenna	36
Max Antenna Gain / Output Power.....	35
Modbus RTU & Modbus ASCII	19
Modifying an Existing Network.....	89
N	
Network Types	16
P	
Parabolic Reflector Antenna	33
Point-Multipoint (Modbus)	19
Printer Settings	74
ProSoft RadioLinx	4
Protocol Transparent Network	17, 18
Q	
Query a Radio	109
Query a Radio Remotely	112
R	
Radio Configuration - Point-Multipoint Modbus	81
Radio Configuration - Point-to-Point	79
Radio Front Panel.....	40
Radio Network Defined	15
Radio Power Requirements.....	41
Radio Rear Panel.....	40
Radios do not communicate	118
Rename Radios	67
S	
Save the Network's Definition.....	72
Save the Radio's Configuration.....	87
Select Radio Color	53
Serial Port Basics	122
Serial Port Factory Defaults Illustrated.....	45
Setting the Ethernet Port	52
Setting The IP Address of the Host Computer	49
Setting the Serial Port.....	44
Setup Overview	11
Site Selection.....	26
Sources of Interference	27
Summary of Function and Use.....	5
Super Zoom	99
System Diagnostics an Overview.....	104
T	
Test the Installation Plan	115

The Setup / Diagnostic Software.....	12
Troubleshooting Overview.....	116
U	
UL 1604 Approval.....	7
UL Standard 1604 Approval.....	7
Upgrade Software - Download Code.....	102
V	
View Operating Network - Ethernet.....	104
Viewing (and Changing) a Radio's Settings.....	93
Viewing Signal Strength.....	106
W	
When to Re-Configure Radios.....	88
Y	
Yagi Array Antenna.....	32
Z	
Zoom In	96
Zoom Out	98
Zoom To Fit	101
Zoom View of Graphical Layout.....	96