



Where Automation Connects.



## RS485 I/O Expansion System

October 17, 2016

**USER GUIDE**



## Your Feedback Please

We always want you to feel that you made the right decision to use our products. If you have suggestions, comments, compliments or complaints about our products, documentation, or support, please write or call us.

## How to Contact Us

### **ProSoft Technology, Inc.**

9201 Camino Media, Suite 200

Bakersfield, CA 93311

+1 (661) 716-5100

+1 (661) 716-5101 (Fax)

<http://www.prosoft-technology.com>

[support@prosoft-technology.com](mailto:support@prosoft-technology.com)

**Copyright © 2016 ProSoft Technology, Inc. All rights reserved.**

RS485 I/O Expansion System User Guide

October 17, 2016

## ProSoft Technology® Product Documentation

In an effort to conserve paper, ProSoft Technology no longer includes printed manuals with our product shipments. User Manuals, Datasheets, Sample Ladder Files, and Configuration Files are provided at:

[www.prosoft-technology.com](http://www.prosoft-technology.com)



# Contents

Your Feedback Please.....	3
How to Contact Us .....	3
ProSoft Technology® Product Documentation .....	3
<b>1 Preface</b>	<b>7</b>
1.1 Compliances.....	8
<b>2 System Overview</b>	<b>9</b>
2.1 Highlights.....	9
2.2 Hardware .....	10
<b>3 Specifications</b>	<b>11</b>
3.1 Hardware and System.....	11
3.2 Safety and Compliance .....	11
3.3 RS485 Expansion I/O Module .....	12
3.4 Digital I/O Module.....	12
3.5 4-20 mA I/O Module .....	13
3.6 0-10 V I/O Module .....	13
3.7 Ordering Information .....	13
<b>4 Installation</b>	<b>15</b>
4.1 Outdoor Enclosure Installation .....	15
4.2 RS485 I/O Expansion System Assembly.....	16
4.3 RS485 Daisy-Chain Diagram .....	20
4.4 Detaching Components from the DataRail.....	21
<b>5 Wiring Diagrams</b>	<b>23</b>
5.1 RS485 I/O Expansion Module .....	23
5.2 Digital Module.....	24
5.3 Analog 4-20 mA Module.....	25
5.4 Analog 0-10 V Module.....	26
<b>6 Modbus Mapping</b>	<b>27</b>
6.1 Supported Modbus Function Codes.....	27
6.2 Digital I/O Module – Modbus Mapping Table .....	27
6.3 4-20 mA I/O Module - Modbus Mapping Table .....	28
6.4 0-10 V I/O Module - Modbus Mapping Table .....	29
<b>7 Diagnostics</b>	<b>31</b>
7.1 Radio Module .....	31

<b>8</b>	<b>Frequently Asked Questions</b>	<b>33</b>
<hr/>		
<b>9</b>	<b>Support, Service &amp; Warranty</b>	<b>35</b>
<hr/>		
9.1	Warranty Information .....	36

# 1 Preface

Thank you for choosing the RS485 I/O Expansion System. This I/O expansion solution is designed for use with any Modbus RS485 Master device as a standalone system. This System follows the Modbus Application Protocol Specification, v1.1b3, for Data Encoding with values represented in Big-Endian format or MSB first (word order).

Digital/Discrete, Analog 4-20 mA, or Analog 0-10 V are available for use with the RS485 I/O Expansion System. This System provides fast, accurate, reliable I/O's and requires no software programming, making it extremely easy and quick to use.

To interface with a RS485 Master device, the System utilizes a RS485 I/O Expansion Module that transfers I/O signals between Modbus Master and connected I/O Modules. The RS485 Module also distributes power to the I/O Modules allowing for single point power termination.

This document is designed to guide you through setting up the system by familiarizing you with the hardware, installation, wiring, and overall system management.

**ProSoft Technology, Inc.**

9201 Camino Media, Suite 200

Bakersfield, CA 93311

+1 (661) 716-5100

+1 (661) 716-5101 (Fax)

<http://www.prosoft-technology.com>

[support@prosoft-technology.com](mailto:support@prosoft-technology.com)

## 1.1 Compliances

- Changes or modifications not expressly approved by the manufacturer may void the user's authority to operate the equipment.

**Warning:** Ensure system installation meets applicable state and national electrical code requirements. The installation of the system should only be performed by a qualified installer or a factory representative.

**Warning:** To prevent ignition of flammable or combustible atmospheres, disconnect power before servicing.

**Caution:** The RS485 I/O Expansion System must be installed within an enclosure that requires a tool to access. This is to prevent inadvertent disconnection of any of the power wiring, signal wiring or communication cables.

**Caution:** EXPLOSION HAZARD. Do not disconnect equipment unless power has been switched off or the area is known to be non-hazardous.

**Caution:** EXPLOSION HAZARD. Do not remove or replace fuse when energized.

**Note:** This equipment is designed for use in Class I, Division 2 (Zone 2) or non-hazardous locations only.



## 2 System Overview

### 2.1 Highlights

- Local I/O expansion solution for use with any RS485 Modbus Master device.
  - System utilizes a pass-through RS485 Interface/Module for transferring I/O signals between Modbus Master and connected I/O Modules
  - One RS485 Expansion I/O Module supports multiple Wireless I/O Modules.
    - System can support up to sixteen (16) Digital Modules
    - System can support up to eight (8) 0-10 V Modules
    - System can support up to five (5) 4-20 mA Modules
-  When adding more than five (5) I/O Modules and mixing different I/O Modules, please determine maximum allowable I/O Module combination per system by utilizing the power budget calculator: <http://psft.com/A7U>
- Supports Digital, 0-10 V, and 4-20 mA Modules in any combination.
  - Each I/O Module provides field isolated inputs and outputs.
  - Easy to use: no software configuration required.
  - System attaches onto 35 mm x 7.5 mm DIN rail with easy, clip-on mounting system.
  - Reduced wire clutter: single power termination.
  - Wiring label provided on each Module for quick reference.
  - All Modules are color-coded for quick reference and identification.
  - The same I/O Modules can also be used for wireless application with Wireless I/O Radio Kit.
  - Reduced wire clutter: single power termination.
  - Quick wiring reference label provided on each Module.
  - Wireless I/O System can support multiple I/O Modules.
    - System can support up to sixteen (16) Digital Modules max.
    - System can support up to eight (8) 0-10 V Modules max.
    - System can support up to five (5) 4-20 mA Modules max.

**Warning:** When adding more than five (5) I/O Modules and mixing different I/O Module combinations, please determine the maximum allowable I/O Module combination per system by utilizing the power budget calculator. See <http://psft.com/A7U>

## 2.2 Hardware



1. RS485 I/O Expansion Module: BM-1000-PM1 (US), BM-0915-RM1 (Int), BM-2400-RM1 (US), BM-2410-RM1 (Int)
2. Digital Module: BM-D100-144 (US); BM-D100-244 (International)
3. 4-20 mA Analog Module: BM-A420-122 (US); BM-A420-122 (International)
4. 0-10 V Analog Module: BM-A010-122 (US); BM-A010-122 (International)



5. DataRail attaches onto 35 mm x 7.5 mm DIN rail (Standard length included in Radio Kit can support 1 RS485 I/O Expansion Module + 5 I/O Modules)
6. End Terminal Bracket for securing DataRail and Modules to DIN Rail
7. DataRail Cover for protecting empty DataRail slots



### 3 Specifications

#### 3.1 Hardware and System

HARDWARE & SYSTEM	
Unique Features	Works with Any Modbus RS485 Master Device No Software Configuration Required Single Point Power Termination
Maximum Network Capacity* 	System can support up to sixteen (16) Digital Modules max System can support up to eight (8) 0-10 V Modules max System can support up to five (5) 4-20 mA Modules max  When adding more than five (5) I/O Modules and creating different I/O Module combinations, please determine maximum allowable I/O Module combination per system by utilizing the power budget calculator.
Power Budget Calculator	<a href="http://psft.com/A7U">http://psft.com/A7U</a>
Data Encoding Method	MSB First
I/O Module Slave ID Selection	16-Position Rotary Switch (+1 for Modbus Slave ID)
DIN Rail Mounting Compatibility	35 mm x 7.5 mm DIN Rail
DataRail™ (Included w/ Kit)	6.1" / 156 mm - Supports Up to Exp. + 5x I/O Modules
Auto-Detection of Modules	Yes, via DataRail at Power-Up
DataRail Mounting Hardware	4-Claw Attachment to 35 mm DIN Rail with End Terminal Bracket
Built-In Mounting Hardware	Spring-Loaded Clip-On System
Wire Gauge	Solid / Stranded (AWG) 28-12 Gauge
Wire Rating	UL: 300 V RMS, 80 °C and 300 V, 105 °C CSA: 300 V RMS, 105 °C
Warranty	2-Year Limited

#### 3.2 Safety and Compliance

SAFETY & COMPLIANCE	RADIO
Operational Temperature	-40 °C to 80 °C / -40 °F to 176 °F
Ambient Temperature	-20 °C to 85 °C / -4 °F to 185 °F
Humidity	0 to 99 %, Non-condensing
Degree of Protection / Housing Type	IP20 / Plastic
Hazardous Locations Classifications	Class I; Division 2 (Zone 2), Pending

### 3.3 RS485 Expansion I/O Module

RS485 Expansion I/O Module	
Baud Rate	9600 bits per second
Data Bits	8
Parity / Stop Bits	None / 1
RS485 Modbus Slave Addressing	Interface Supports up to 16 Addresses / I/O Modules*
Red LED (Left)	Power
Green LED (Right)	USB-Ready (For Firmware Update)
Supply Voltage Range	9 - 30 VDC ( $\pm 5\%$ )
Protection Against Polarity	Yes
Power Consumption	Typical: 20 mA / Max: 24 mA @12 VDC
Packaging Dimensions (WxHxD)	5.5 x 10.1 x 2.8-in / 140 x 257 x 72mm
Net Dimensions (WxHxD)	0.7 x 3.9 x 4.5-in / 17.5 x 99 x 114mm
Packaging Weight	0.8 lbs / 363 g
Net Weight	0.3 lbs / 136 g

### 3.4 Digital I/O Module

Digital I/O Module	
Number of Inputs	4
Number of Outputs	4
Isolation Voltage	2500 V r.m.s.
Input Voltage Range	3-30 VDC
Input Voltage Threshold	1 Signal ("H"): > 2.3 VDC
	0 Signal ("L"): < 1.1 VDC
Output Rating	1 A Sink Current for Open-Drain Outputs / NPN
Green LEDs	Input Indicators
Red LEDs	Output Indicators
Power Consumption	Typical: 18 mA / Max: 26 mA @12 VDC
Packaging Dimensions	(WxHxD) 4.8 x 5.1 x 2.8-in / 123 x 129 x 72mm
Net Dimensions	0.7 x 3.9 x 4.5-in / 17.5 x 99 x 114mm
Packaging Weight	Single: 0.5 lbs / 227 g; Double: 0.8 lbs / 363 g
Net Weight (Single)	0.3 lbs / 136 g

### 3.5 4-20 mA I/O Module

Analog 4-20 mA I/O Module	
Number of Inputs	2 (24-bit Resolution)
Number of Outputs	2 (16-bit Resolution)
Isolation Voltage	2500 V r.m.s.
Signal Range	4 mA to 20 mA
Accuracy	< 0.28 % of Full Scale
Internal Loop Power	+13.5 VDC
AI Input Impedance (loop)	128 Ohm
AO Terminal Voltage Range	10 VDC Min. / 31.5 VDC Max.
Power Consumption	Typical: 50 mA / Max: 75 mA @12 VDC
Packaging Dimensions	(WxHxD) 4.8 x 5.1 x 2.8-in / 123 x 129 x 72mm
Net Dimensions	0.7 x 3.9 x 4.5-in / 17.5 x 99 x 114mm
Packaging Weight	Single: 0.5 lbs / 227 g; Double: 0.8 lbs / 363 g
Net Weight (Single)	0.3 lbs / 136 g

### 3.6 0-10 V I/O Module

Analog 0-10 V I/O Module	
Number of Inputs	2 (24-bit Resolution)
Number of Outputs	2 (16-bit Resolution)
Isolation Voltage	2500 V r.m.s.
Signal Range	0 VDC to 10 VDC (10.5 V Max)
Accuracy	< 0.1 % of Full Scale
AI Input Impedance	40K Ohm
AO Output Impedance	10 Ohm
Power Consumption	Typical: 40 mA / Max: 45 mA @12 VDC
Packaging Dimensions	(WxHxD) 4.8 x 5.1 x 2.8-in / 123 x 129 x 72mm
Net Dimensions	0.7 x 3.9 x 4.5-in / 17.5 x 99 x 114mm
Packaging Weight	Single: 0.5 lbs / 227 g; Double: 0.8 lbs / 363 g
Net Weight (Single)	0.3 lbs / 136 g

### 3.7 Ordering Information

ORDERING INFORMATION	RS485
RS485 Expansion Kit	BM-1000-PM1K
Kit Content	RS485 Expansion I/O Module, DataRail, 2x End Terminal Brackets, DataRail Cover, Quick Start Guide, Technician's Screwdriver
Digital I/O	1-Pack: BM-D100-144S
	2-Pack: BM-D100-144D
4-20 mA I/O	1-Pack: BM-A420-122S
	2-Pack: BM-A420-122D
0-10 V I/O	1-Pack: BM-A010-122S
	2-Pack: BM-A010-122D



## 4 Installation

### 4.1 Outdoor Enclosure Installation

1. Install or use existing outdoor NEMA-type enclosure.
2. Be sure the RS485 I/O Expansion System meets applicable grounding requirements in the enclosure.
3. Install a 35 mm x 7.5 mm DIN rail (at least 166 mm (6.5-inch) wide) inside the enclosure.
4. Provide external power supply: 9-30 VDC.
5. Make a hole on the bottom of the enclosure to run wires.
6. Run conduit for power and I/O cabling.
7. Feed power wiring into enclosure.
8. Terminate RS485 wiring.

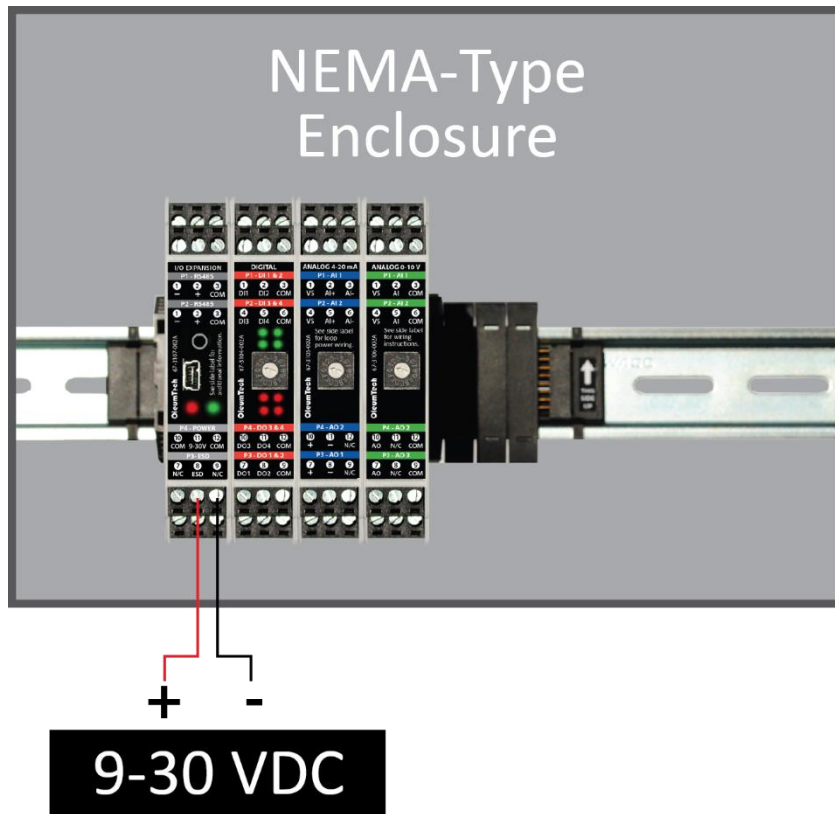

## 4.2 RS485 I/O Expansion System Assembly

**Warning:** Power must be disconnected or turned off prior to attaching or removing any I/O Modules from the system – failure to comply may cause damage hardware.

1. Securely attach the DataRail onto a 35 mm x 7.5 mm DIN rail by gently pressing on all four (4) corner clips.



Attach DataRail with arrow pointing up.

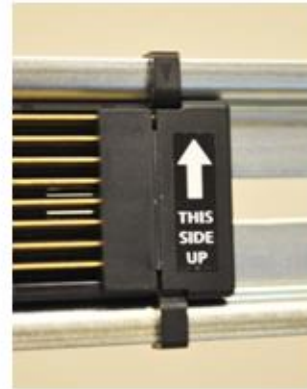

2. Secure DataRail to DIN rail by attaching an End Terminal Bracket.
  - a. First, hook the metal end of the Bracket to DIN rail and then snap the other end onto the DIN rail. (Make sure to position the Bracket on the far left of the DataRail where metal blades meet the plastic).



Attach components from left to right without gap.

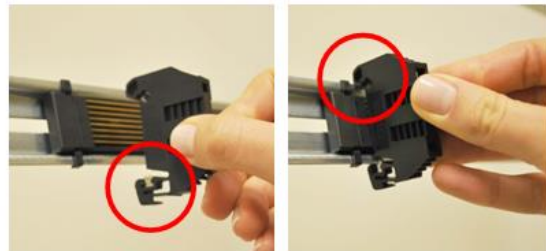



3. Attach RS485 I/O Expansion Module to DataRail (place it next to the Bracket without any gap).
  - a. First, latch the top hook onto the rail, then snap-in the spring-loaded clip into place.

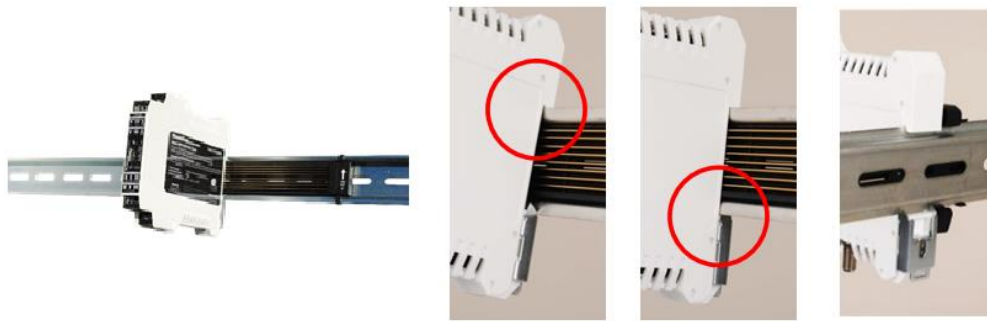

4. Attach I/O Module(s) to the system.
  - a. Place Modules in any combination (do not leave gaps between Modules).
  - b. When using more than five (5) I/O Modules, determine maximum I/O Module combination by using power budget calculator: <http://psft.com/A7U>



- c. Use the 16-position switch located on the front of each I/O Module to set the Modbus Slave ID(s). Slave ID = Switch position number + 1.  
Ex: Switch ID 0 + 1 = Slave ID 1

$$\text{SLAVE ID} = \begin{matrix} & 1 & 2 & 3 & 4 & 5 & 6 & 7 & 8 & 9 & 10 & 11 & 12 & 13 & 14 & 15 & 16 \\ 10 & & & & & & & & & & & & & & & & & \\ & A & B & C & D & E & F & G & H & I & J & K & L & M & N & O & P & \\ & & & & & & & & & & & & & & & & & \end{matrix} + 1$$



5. Attach the other End Terminal Bracket to secure the Modules. (Place it next to the last module without leaving a gap)



6. Protect any unused DataRail slots with the cover. Snap-off extra pieces and store for future use.



7. Terminate the RS485 terminals.

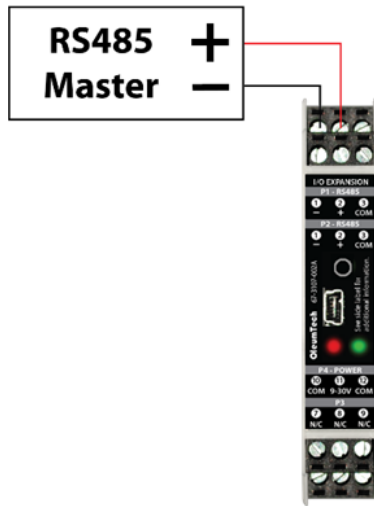

8. Terminate I/O and supply power as required. Use solid or stranded wire (AWG) 28-12.

### 4.3 RS485 Daisy-Chain Diagram

1. If more I/O Modules are required, another RS485 I/O Expansion Module (Kit) set can be deployed simply using the daisy-chain method.
2. The System holds up to 16 I/O Module Slave addresses regardless of the number of RS485 I/O Expansion Modules deployed.
3. Each Module must be set to a unique Modbus Slave address.

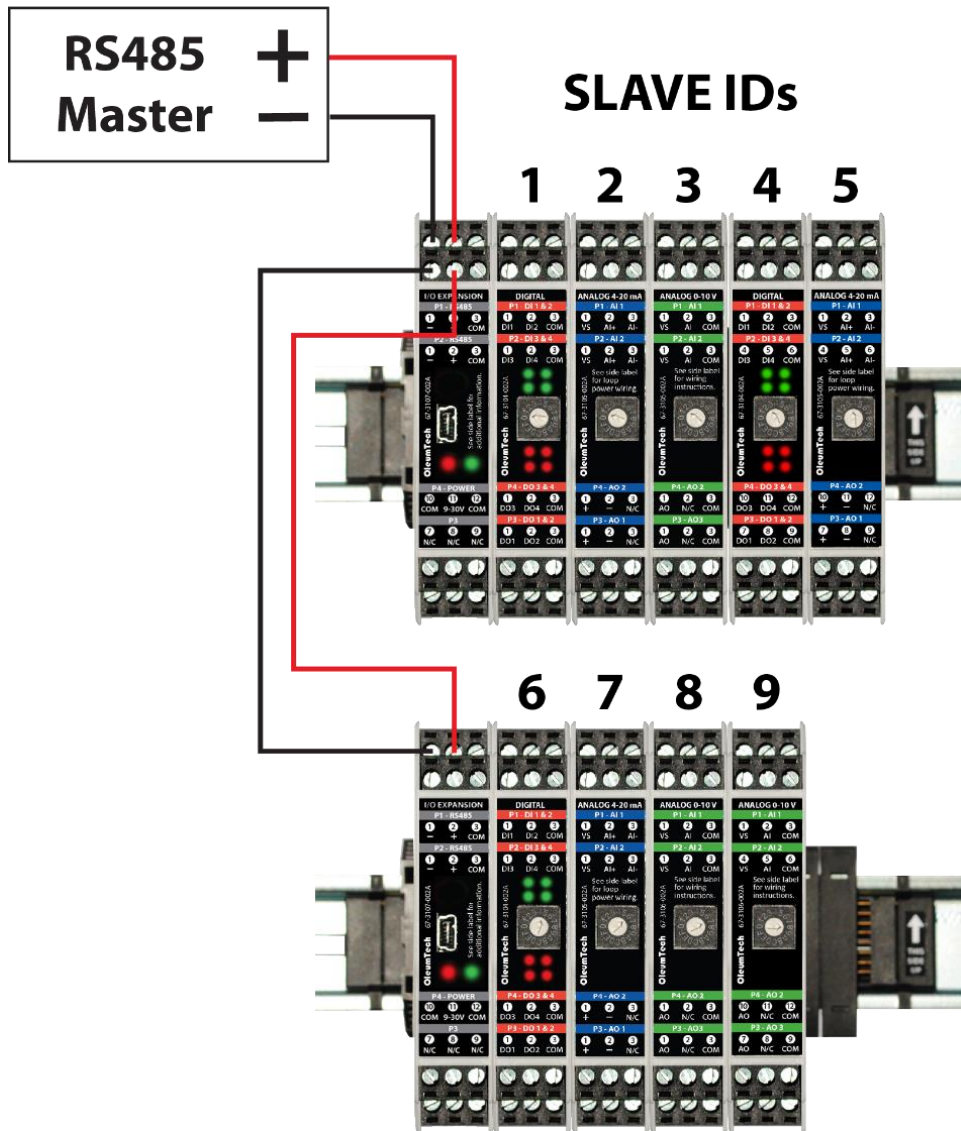

#### 4.4 Detaching Components from the DataRail

**Warning:** All live wiring connections and power must be safely disconnected before taking any components off the DataRail or Wireless I/O System!

1. The End Terminal Bracket can be removed from the DIN rail by inserting the tip of a flathead screwdriver into the removal slot. Control the direction with the screwdriver handle to pull the latch away from the DIN rail.

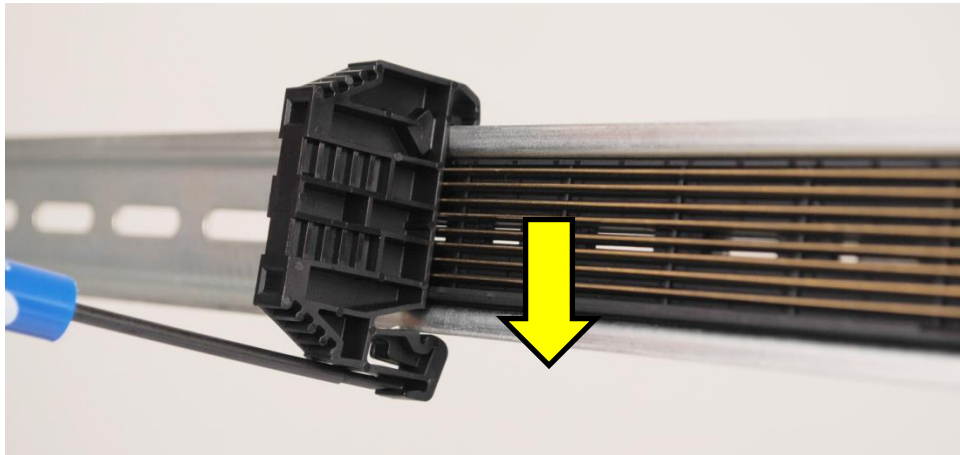

2. Wireless I/O Modules can be removed from the DIN rail by inserting the tip of a flathead screwdriver into removal slot located on the metal clip. Lift-up on the screwdriver handle to pull the spring-loaded clip away from the DIN rail.







## 5 Wiring Diagrams

### 5.1 RS485 I/O Expansion Module

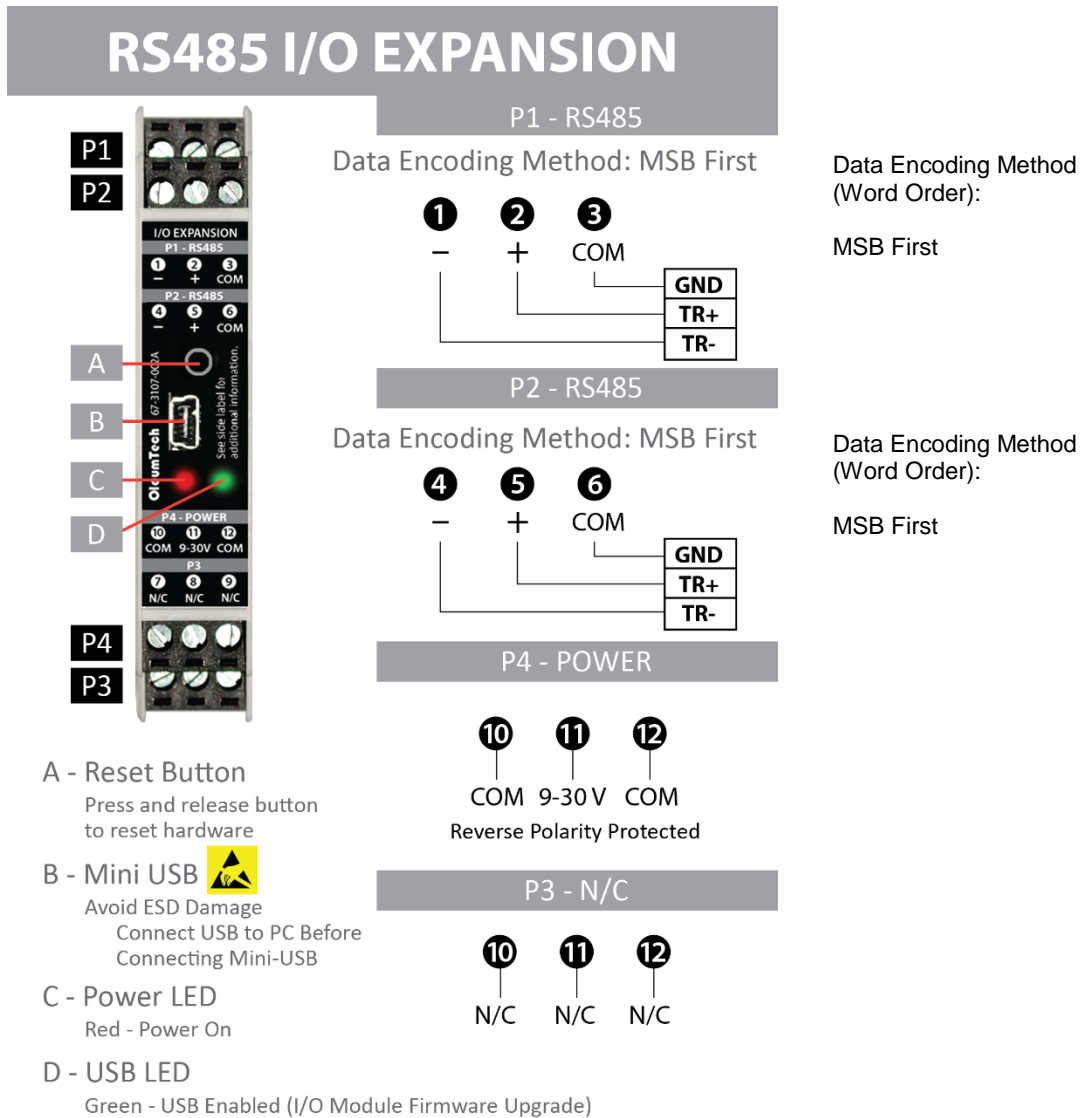
(BM-1000-PM1 Shown)



Use Solid / Stranded (AWG) 28-12 Wire Gauge

 **RS485 I/O Expansion Module does not share a common ground with I/O Modules. All inputs and outputs on I/O Modules provide field isolation.**

## 5.2 Digital Module

(BM-D100-144 Shown)

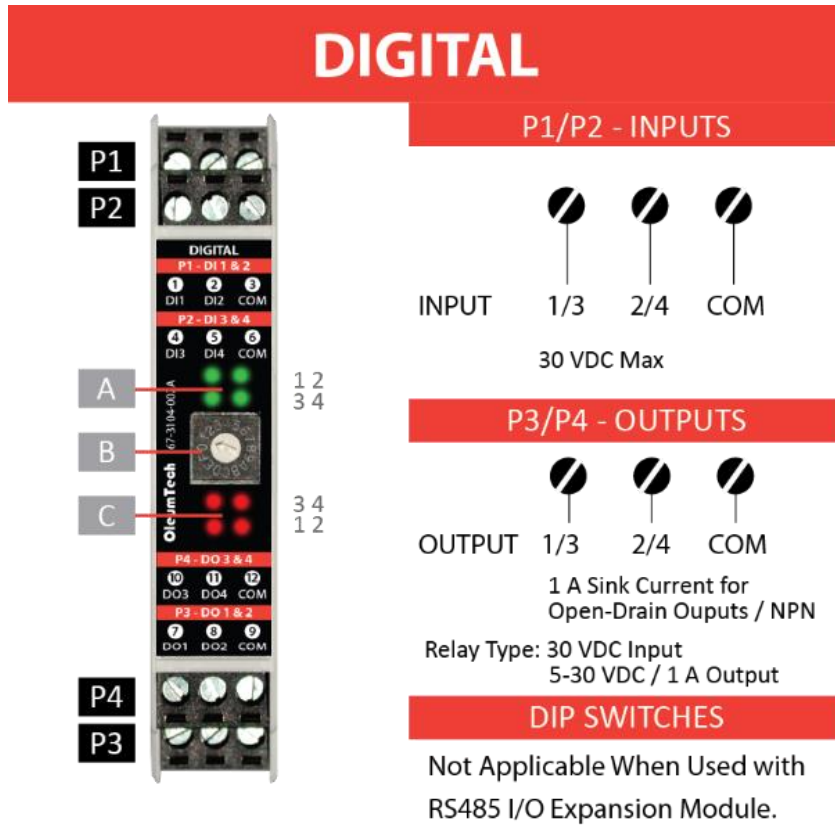

- A - Input LEDs  
Illuminated When Active
- B - 16-Position Slave ID Switch  
Slave ID = Switch Position + 1
- C - Output LEDs  
Illuminated When Active

Use Solid / Stranded (AWG) 28-12 Wire Gauge



Digital I/O Module does not share a common ground with RS485 Module. All inputs and outputs on I/O Modules provide field isolation.

If input sensor is powered from the same source as RS485 Module, be sure to establish a common ground, otherwise sensor will not work properly.



### 5.3 Analog 4-20 mA Module (BM-A420-122 Shown)

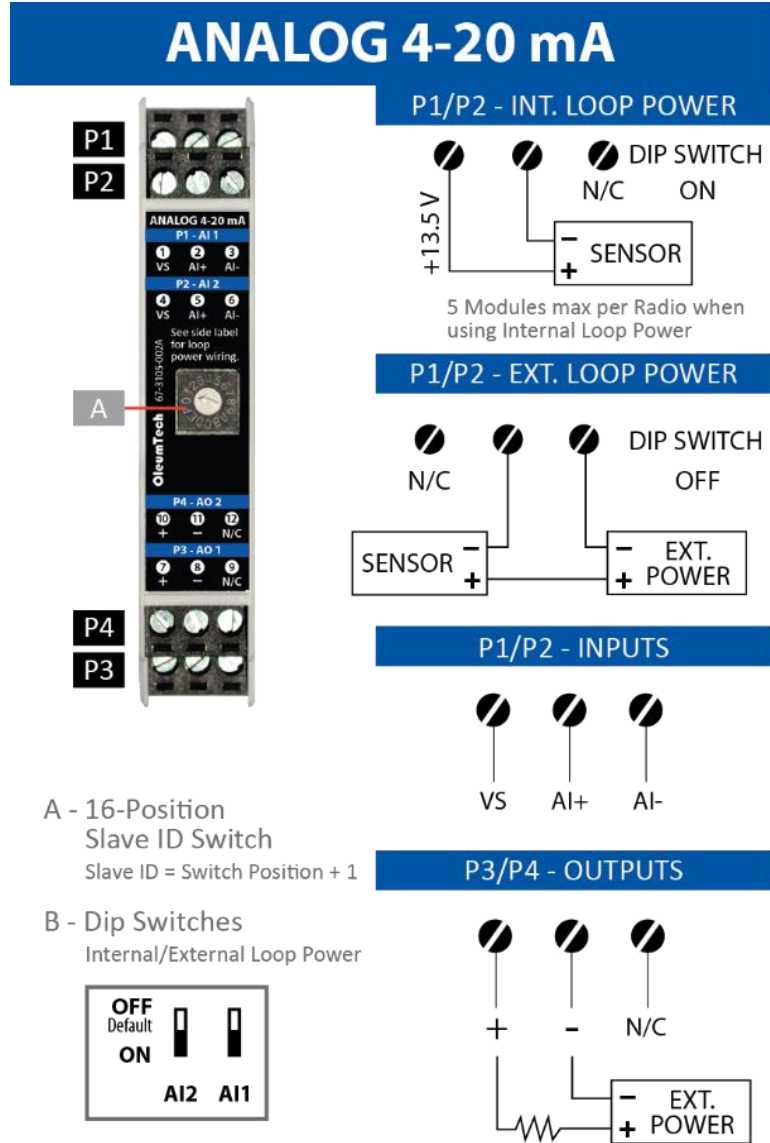

VS/External Power (min) = 10 + Max Current (Amp) \* R<sub>loop</sub>  
R<sub>loop</sub> = Total Loop Impedance

Use Solid / Stranded (AWG) 28-12 Wire Gauge

 4-20 mA I/O Module does not share a common ground with RS485 Module. All inputs and outputs on I/O Modules provide field isolation.



## 5.4 Analog 0-10 V Module

(BM-A010-122 Shown)

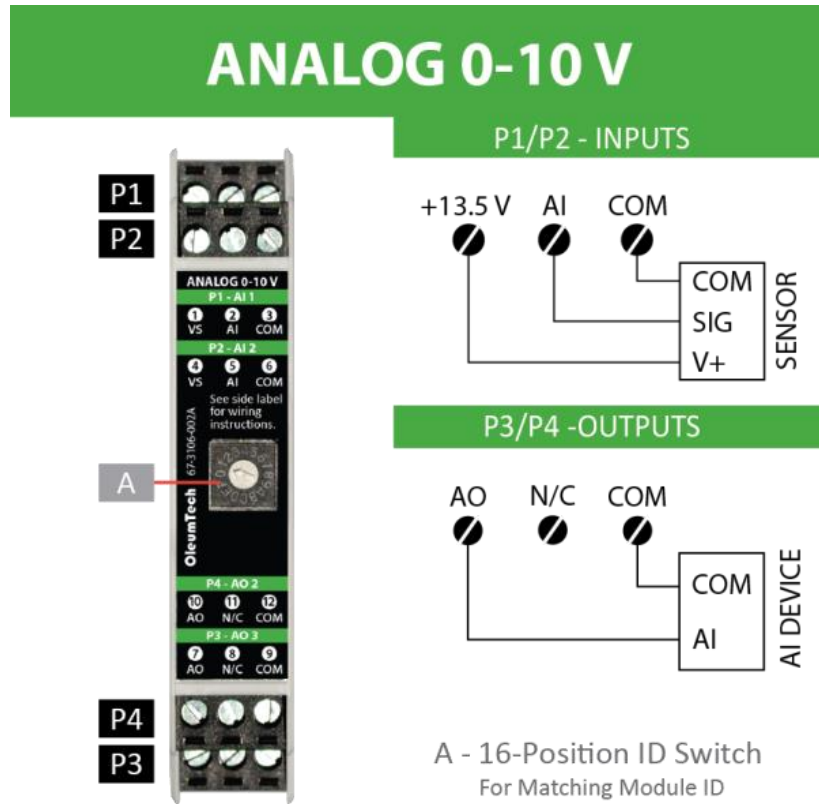

Use Solid / Stranded (AWG) 28-12 Wire Gauge



0-10 V I/O Module does not share a common ground with RS485 Module.  
All inputs and outputs on I/O Modules provide field isolation.

## 6 Modbus Mapping

### 6.1 Supported Modbus Function Codes

Supported Function Codes	Definitions	Applicable Module(s)
0x01	Read Coils	Digital
0x02	Read Discrete Inputs	Digital
0x03	Read Holding Registers	Digital, 4-20mA, 0-10 V
0x05	Write Single Coil	Digital
0x06	Write Single Register	Digital, 4-20mA, 0-10 V
0x10	Write Multiple Registers	Digital, 4-20mA, 0-10 V
0x0F	Write Multiple Coils	Digital

### 6.2 Digital I/O Module – Modbus Mapping Table

Modbus Function	Address	Description	Access	Type	Range
0x01	1..4	Discrete Output 1..4	Read	BIT	4321
0x02	1..4	Discrete Input 1..4	Read	BIT	4321
0x05, 0x0F	1..4	Discrete Output 1..4	Write	BIT	0xFF00/0x0000, ----4321
0x03, 0x06, 0x10	3001..3004	Discrete Input 1..4	Read	UINT 16	0..1
0x03, 0x06, 0x10	3005..3008	Discrete Output 1..4	Read/Write	UINT 16	0..1

### 6.3 4-20 mA I/O Module - Modbus Mapping Table

HR	Description	Access	Type	Range
3001	Analog Input 1 Current /1000	Read	UINT 16	4000..20,000
3002	Analog Input 2 Current /1000	Read	UINT 16	4000..20,000
3003	Analog Input 1 Raw Split-Hi	Read	UINT 32	0..8,388,607
3004	Analog Input 1 Raw Split-Lo			
3005	Analog Input 2 Raw Split-Hi	Read	UINT 32	0..8,388,607
3006	Analog Input 2 Raw Split-Lo			
3007	Analog Input 1 Current Split-Hi	Read	IEE FLOAT	4.0..20.0
3008	Analog Input 1 Current Split-Lo			
3009	Analog Input 2 Current Split-Hi	Read	IEE FLOAT	4.0..20.0
3010	Analog Input 2 Current Split-Lo			
3011	Analog Output 1 Current /1000	Read/Write	UINT 16	0..20,000
3012	Analog Output 2 Current /1000	Read/Write	UINT 16	0..20,000
3013	Analog Output 1 % /100	Read/Write	UINT 16	0..10,000
3014	Analog Output 2 % /100	Read/Write	UINT 16	0..10,000
3015	Analog Output 1 Current Split-Hi	Read/Write	IEE FLOAT	4.0..20.0
3016	Analog Output 1 Current Split-Lo			
3017	Analog Output 2 Current Split-Hi	Read/Write	IEE FLOAT	4.0..20.0
3018	Analog Output 2 Current Split-Lo			
3019	Analog Output 1 % Split-Hi	Read/Write	IEE FLOAT	0.0..100.0
3020	Analog Output 1 % Split-Lo			
3021	Analog Output 2 % Split-Hi	Read/Write	IEE FLOAT	0.0..100.0
3022	Analog Output 2 % Split-Lo			
5001	Analog Input 1 Raw	Read	UINT 32	0..8,388,607
5002	Analog Input 2 Raw	Read	UINT 32	0..8,388,607
7001	Analog Input 1 Current	Read	IEE FLOAT	4.0..20.0
7002	Analog Input 2 Current	Read	IEE FLOAT	4.0..20.0
7003	Analog Output 1 Current	Read/Write	IEE FLOAT	4.0..20.0
7004	Analog Output 2 Current	Read/Write	IEE FLOAT	4.0..20.0
7005	Analog Output 1 %	Read/Write	IEE FLOAT	0.0..100.0
7006	Analog Output 2 %	Read/Write	IEE FLOAT	0.0..100.0

### 6.4 0-10 V I/O Module - Modbus Mapping Table

HR	Description	Access	Type	Range
3001	Analog Input 1 Volts /1000	Read	UINT 16	0..10,000
3002	Analog Input 2 Volts /1000	Read	UINT 16	0..10,000
3003	Analog Input 1 Raw Split-Hi	Read	UINT 32	0..8,388,607
3004	Analog Input 1 Raw Split-Lo			
3005	Analog Input 2 Raw Split-Hi	Read	UINT 32	0..8,388,607
3006	Analog Input 2 Raw Split-Lo			
3007	Analog Input 1 Volts Split-Hi	Read	IEE FLOAT	0.0..10.0
3008	Analog Input 1 Volts Split-Lo			
3009	Analog Input 2 Volts Split-Hi	Read	IEE FLOAT	0.0..10.0
3010	Analog Input 2 Volts Split-Lo			
3011	Analog Output 1 Raw	Read/Write	UINT 16	0..65,535
3012	Analog Output 2 Raw	Read/Write	UINT 16	0..65,535
3013	Analog Output 1 Volts /1000, % /100	Read/Write	UINT 16	0..10,000
3014	Analog Output 2 Volts /1000, % /100	Read/Write	UINT 16	0..10,000
3015	Analog Output 1 Volts Split-Hi	Read/Write	IEE FLOAT	0.0..10.0
3016	Analog Output 1 Volts Split-Lo			
3017	Analog Output 2 Volts Split-Hi	Read/Write	IEE FLOAT	0.0..10.0
3018	Analog Output 2 Volts Split-Lo			
3019	Analog Output 1 % Split-Hi	Read/Write	IEE FLOAT	0.0..100.0
3020	Analog Output 1 % Split-Lo			
3021	Analog Output 2 % Split-Hi	Read/Write	IEE FLOAT	0.0..100.0
3022	Analog Output 2 % Split-Lo			
5001	Analog Input 1 Raw	Read	UINT 32	0..8,388,607
5002	Analog Input 2 Raw	Read	UINT 32	0..8,388,607
7001	Analog Input 1 Volts	Read	IEE FLOAT	0.0..10.0
7002	Analog Input 2 Volts	Read	IEE FLOAT	0.0..10.0
7003	Analog Output 1 Raw	Read/Write	IEE FLOAT	0.0..65,535.0
7004	Analog Output 2 Raw	Read/Write	IEE FLOAT	0.0..65,535.0
7005	Analog Output 1 Volts	Read/Write	IEE FLOAT	0.0..10.0
7006	Analog Output 2 Volts	Read/Write	IEE FLOAT	0.0..10.0
7007	Analog Output 1 %	Read/Write	IEE FLOAT	0.0..100.0
7008	Analog Output 2 %	Read/Write	IEE FLOAT	0.0..100.0



## 7 Diagnostics

### 7.1 Radio Module

#### 1. Power LED (Left)

- a. **Red:** Power on
- b. **LED not on:** No power
  - i. Verify power supply wiring and polarity. (+ to 9-30V, - to COM)
  - ii. Verify correct pin outs are used. (pin 11 for +, pin 10 or 12 for -)
  - iii. Verify 9-30 VDC is supplied to the unit.



## 2. I/O LED (Right):

- a. **Green:** USB enabled
- b. **LED not on:** No power
  - i. Connect USB to PC first, then to I/O Expansion Module.
  - ii. Verify unit is powered on, Power LED (left) should be red.
  - iii. Verify the PC is on.



## 3. Unable to Read/Write Modbus Values

- a. Verify that the Modbus slave ID is the Module ID + 1  
**Example:** If the Module ID is 0, the Modbus slave ID will be 1
- b. Select MSB first when applicable when setting up Modbus Master device.
- c. Verify Modbus RS485 wiring (3-wire).
- d. Verify baud rate, data bits, parity, and stop bits (9600 / 8 / None / 1).
- e. Refer to Modbus Mapping (page 27).
  - i. Verify the Modbus function code.
  - ii. Verify the Modbus register address.
  - iii. Verify the data type (integer/float, 16/32 bit).
  - iv. Verify if address has read/write or only read function capabilities.



## 8 Frequently Asked Questions

1. What is the RS485 I/O Expansion System designed for?
  - a. It is designed to easily and economically add local I/O points to any industrial monitoring or control system via RS485 Modbus connectivity.
2. What type of I/O's are available?
  - a. Digital/discrete
  - b. Analog 4-20 mA
  - c. Analog 0-10 V
3. Does this System require software configuration?
  - a. No, it requires absolutely no software.
  - b. Slave ID switch on each I/O Module is used to set the Slave ID.
  - c. The RS485 I/O Expansion Modules provides power and controls the I/O images.
4. How many I/O Modules can I connect to one RS485 expansion I/O system?
  - a. Digital: up to 16
  - b. 4-20 mA: up to 5
  - c. 0-10 V: up to 8
  - d. When mixing Modules, use Power Budget Calculator to determine max number of Modules per system: <http://psft.com/A7U>
5. Can I use the same I/O Modules with the WIO® Wireless System for replicating hardwire?
  - a. Yes, the WIO I/O Modules can be used for both wireless and RS485 I/O applications
6. Do the I/O Modules require a firmware change when changing from RS485 to wireless application?
  - a. No, the I/O Modules are designed to work with either the WIO® Radios or RS485 I/O Expansion Module.
7. How many I/O modules can be connected with the standard DataRail (6.1") shipped with RS485 Kit?
  - a. Standard DataRail supports up to five (5) I/O modules in addition to one RS485 Module.
8. What is the mini USB port on the RS485 Module used for?
  - a. For updating device firmware via PC.
9. Can the RS485 I/O Expansion System be used in hazardous locations?
  - a. Yes, the system can be used in Class 1, Division 2 or Zone 2 locations. Certification pending.
10. How can I obtain tech support or RMA?
  - a. Please email us at [support@prosoft-technology.com](mailto:support@prosoft-technology.com) or give us a call to begin the service process. You will be guided by our helpful customer service staff member to help you get through any issue you are having with the Wireless I/O System.



## 9 Support, Service & Warranty

ProSoft Technology, Inc. (ProSoft) is committed to providing the most efficient and effective support possible. Before calling, please gather the following information to assist in expediting this process:

- 1 Product Version Number
- 2 System architecture
- 3 Network details

If the issue is hardware related, we will also need information regarding:

- 1 Module configuration and associated ladder files, if any
- 2 Module operation and any unusual behavior
- 3 Configuration/Debug status information
- 4 LED patterns
- 5 Details about the serial, Ethernet or fieldbus devices interfaced to the module, if any.

**Note:** For technical support calls within the United States, an after-hours answering system allows 24-hour/7-days-a-week pager access to one of our qualified Technical and/or Application Support Engineers. Detailed contact information for all our worldwide locations is available on the following page.

<b>Internet</b>	Web Site: <a href="http://www.prosoft-technology.com/support">www.prosoft-technology.com/support</a> E-mail address: <a href="mailto:support@prosoft-technology.com">support@prosoft-technology.com</a>
<b>Asia Pacific</b> (location in Malaysia)	Tel: +603.7724.2080, E-mail: <a href="mailto:asiapc@prosoft-technology.com">asiapc@prosoft-technology.com</a> Languages spoken include: Chinese, English
<b>Asia Pacific</b> (location in China)	Tel: +86.21.5187.7337 x888, E-mail: <a href="mailto:asiapc@prosoft-technology.com">asiapc@prosoft-technology.com</a> Languages spoken include: Chinese, English
<b>Europe</b> (location in Toulouse, France)	Tel: +33 (0) 5.34.36.87.20, E-mail: <a href="mailto:support.EMEA@prosoft-technology.com">support.EMEA@prosoft-technology.com</a> Languages spoken include: French, English
<b>Europe</b> (location in Dubai, UAE)	Tel: +971 (0)4.214.6911, E-mail: <a href="mailto:mea@prosoft-technology.com">mea@prosoft-technology.com</a> Languages spoken include: English, Hindi
<b>North America</b> (location in California)	Tel: +1 661-716-5100, E-mail: <a href="mailto:support@prosoft-technology.com">support@prosoft-technology.com</a> Languages spoken include: English, Spanish
<b>Latin America</b> (Oficina Regional)	Tel: +1-281-298-9109, E-Mail: <a href="mailto:latinam@prosoft-technology.com">latinam@prosoft-technology.com</a> Languages spoken include: Spanish, English
<b>Latin America</b> (location in Puebla, Mexico)	Tel: +52-222-399-6565, E-mail: <a href="mailto:soporte@prosoft-technology.com">soporte@prosoft-technology.com</a> Languages spoken include: Spanish
<b>Brasil</b> (location in Sao Paulo)	Tel: +55-11-5083-3776, E-mail: <a href="mailto:brasil@prosoft-technology.com">brasil@prosoft-technology.com</a> Languages spoken include: Portuguese, English

## 9.1 Warranty Information

For complete details regarding ProSoft Technology's TERMS & CONDITIONS OF SALE, WARRANTY, SUPPORT, SERVICE AND RETURN MATERIAL AUTHORIZATION INSTRUCTIONS go to: [www.prosoft-technology.com/warranty](http://www.prosoft-technology.com/warranty)

All documentation is subject to change without notice.