

OleumTech® Wio®



Radio Kit with Onboard I/O

User Guide

Version 80-7059-001_E

Model Numbers

BR-0900-RM4 | BR-0915-RM4 | BR-2400-RM4

CONTENTS

1. PREFACE/SAFETY	2
2. SAFETY AND COMPLIANCE.....	3
3. SYSTEM OVERVIEW	4
4. SIGNAL CHAIN DIAGRAM	5
5. HARDWARE AT A GLANCE.....	6
6. RF DIAGNOSTICS AND TRANSMISSION SPEED	7
7. DIP SWITCH FUNCTIONS	8
8. RF SETUP – BEST PRACTICES	13
9. INSTALLATION	14
10. WIRING DIAGRAM.....	16
11. SPECIFICATIONS	21
12. CONDITIONS OF ACCEPTABILITY	23
13. WARRANTY.....	24
14. REVISION HISTORY	25

1. PREFACE/SAFETY

Thank you for choosing the WIO® System - Radio Kit with Onboard I/O by OleumTech®.

In order to make the most of the advanced features and performance provided by this wireless I/O system, please read this user guide thoroughly before using the system.

If you have any questions or comments about this product, you may call or email:

ProSoft Technology Support Services
1.661.716.5100
support@prosoft-technology.com



WARNING: Ensure installation of the system meets applicable state and national electrical code requirements.



WARNING: The installation of the system should only be performed by a qualified installer.



WARNING: When connecting the device to an external power supply, do not exceed the defined voltage: 9-30 Vdc max.



WARNING: Contains no user serviceable parts. Unauthorized modification to device or supplied accessories may damage devices and void warranty.



WARNING: This product is NOT intended for use in hazardous locations.



WARNING: Do NOT install or mount on an application with high vibration.



WARNING: The WIO System must be installed within an enclosure that requires a tool to access. This is to prevent inadvertent disconnection of any of the power wiring, signal wiring or communication cables.



AVERTISSEMENT: Assurez-vous que l'installation du système répond aux exigences du code électrique national et national en vigueur.



AVERTISSEMENT: L'installation du système ne doit être effectuée que par un installateur qualifié.



AVERTISSEMENT: Lors de la connexion de l'appareil à une alimentation externe, ne pas dépasser la tension définie: 9-30 Vdc max



AVERTISSEMENT: Ne contient aucune pièce réparable par l'utilisateur. Toute modification non autorisée de l'appareil ou des accessoires fournis peut endommager les appareils et annuler la garantie.



AVERTISSEMENT: Ce produit N'EST PAS destiné à être utilisé dans des endroits dangereux.



AVERTISSEMENT: NE PAS installer ou monter sur une application présentant de fortes vibrations.



AVERTISSEMENT: Le système WIO doit être installé dans un boîtier nécessitant un outil. Ceci a pour but d'empêcher la déconnexion par inadvertance du câblage d'alimentation, du câblage de signal ou des câbles de communication.

2. SAFETY AND COMPLIANCE

Important Information to the User

- This device MUST be professionally installed only by a factory representative or a trained authorized technician.
- Changes or modifications not expressly approved by the manufacturer may void the user’s authority to operate the equipment.
- This device complies with Part 15 of the FCC Rules. Operation is subject to the following two conditions: 1) this device may not cause harmful interference, and 2) this device must accept any interference received, including interference that may cause undesired operation.
- To reduce potential radio interference to other users, install and use only the antenna supplied by the manufacturer to ensure successful communications.

FCC RF Exposure

To comply with FCC RF exposure compliance requirements, a separation distance of at least 20 cm must be maintained between the antenna of this device and all persons.

FCC Interfere

This equipment has been tested and found to comply with the limits for a class B digital device, pursuant to Part 15 of the FCC Rules. These limits are designed to provide reasonable protection against harmful interference in a residential installation. This equipment generates, uses and can radiate radio frequency energy and if not installed and used in accordance with the instructions, may cause harmful communications to radio communications. However, there is no guarantee that interference will not occur in a particular installation. If this equipment does cause harmful interference to radio or television reception, which can be determined by turning the equipment off and on, the user is encouraged to try to correct the interference by one of the following measures:

- Reorient or relocate the antenna.
- Increase the separation between the equipment and receiver.
- Consult the manufacturer for technical help.

This equipment has been certified to comply with the limits for a class B computing device, pursuant to FCC Rules. In order to maintain compliance with FCC regulations, shielded cables must be used with this equipment. Operation with non-approved equipment or use of unshielded cables is likely to result in interference to radio and television reception. The user is cautioned that changes or modifications made to the equipment without the approval of the manufacturer could void the user’s authority to operate this equipment.



CAN/CSA-C22.2 No. 61010-1-12
 CAN/CSA-IEC 61010-2-14
 UL 61010-1, UL 61010-2-201-14
 Equipment Class II, Pollution Degree 2
 Not intended for use in hazardous locations

Environmental Conditions:
 Storage Temp: -40°C to 80°C (-40°F to 176°F)
 Operating Temp: -40°C to 80°C (-40°F to 176°F)
 Relative Humidity: Operating: Up to 99% non-condensing
 Non-Operating: Up to 99% non-condensing
 Protection Degree: Pollution degree 2
 Altitude: up to 2000m

3. SYSTEM OVERVIEW

Highlights

- Wireless I/O mirroring system
- Integrated radio and I/O design
- Two 4-20 mA inputs/outputs (Radio Module A to B)
- Two configurable discrete I/O (Bi-directional)
- Fixed I/O count for ease of use
- No software or programming required
- -40 °C to 80 °C
- 900 MHz, 915 MHz, or 2.4 GHz radio option
- Secure AES encryption
- US Patent #8,811,459 B1

Integrated Radio and I/O Design

The OleumTech® WIO® Radio Kit with Onboard I/O provides instant I/O connectivity and is one of the easiest and most cost-effective solutions for solving a vast number of point-to-point I/O and stranded asset monitoring and control challenges. The kit is comprised of Radio Modules A and B.

The RM4 Wireless I/O Kit provides two unidirectional analog 4-20 mA inputs and outputs (Module A to B only). It also provides two independently configurable discrete I/O channels that can be set up for the signals to travel in either direction (Module A to B or B to A). For the sake of simplicity and ease of use, the I/O count in this system is fixed (non-expandable). The RM4 Kit is designed for use in non-hazardous/ordinary locations.

Reliable, Robust, and Secure

The WIO System leverages reliable, robust, and secure RF technology that replaces traditional hardwire systems by eliminating the need to trench and run conduit and wire. Thus, the WIO System provides a significant reduction in both setup time and cost to its users.

The RM4 Wireless I/O Kit is available in 900 MHz, 915 MHz, or 2.4 GHz option. The Radio Kit comes paired from the factory, meaning there is no programming involved, and the over-the-air connection is instant once the system is up and running. The system offers secure RF communication using AES encryption and fail-safe output protection in case RF traffic is interrupted for any reason. The communication response time can be set to either 400 ms or 1 second, giving you additional control over update speed and power consumption.

4. SIGNAL CHAIN DIAGRAM

A. Analog 4-20 mA

Analog signals travel only in one direction from Radio A to Radio B.

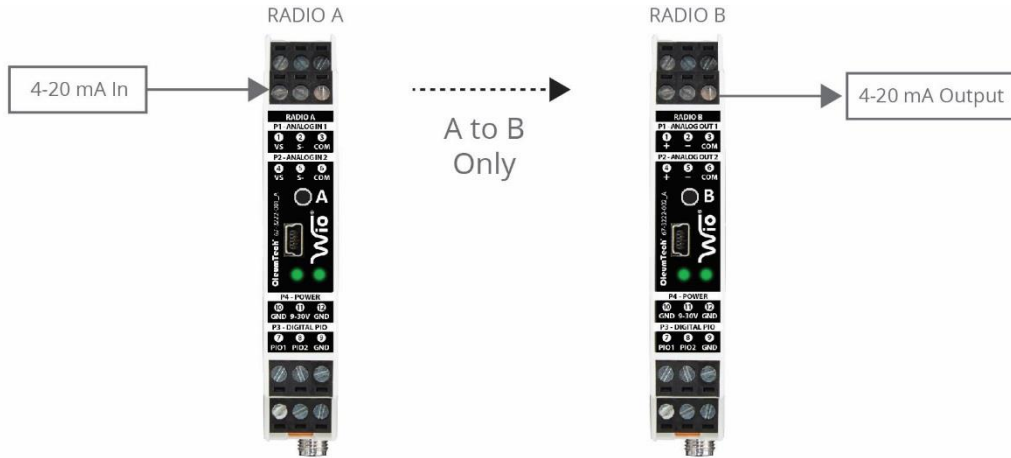

B. Digital/Discrete Programmable I/O (PIO)

The direction of digital signals are programmable by channel, meaning they can travel in either direction based on DIP switch configuration: Radio A to B or Radio B to A.

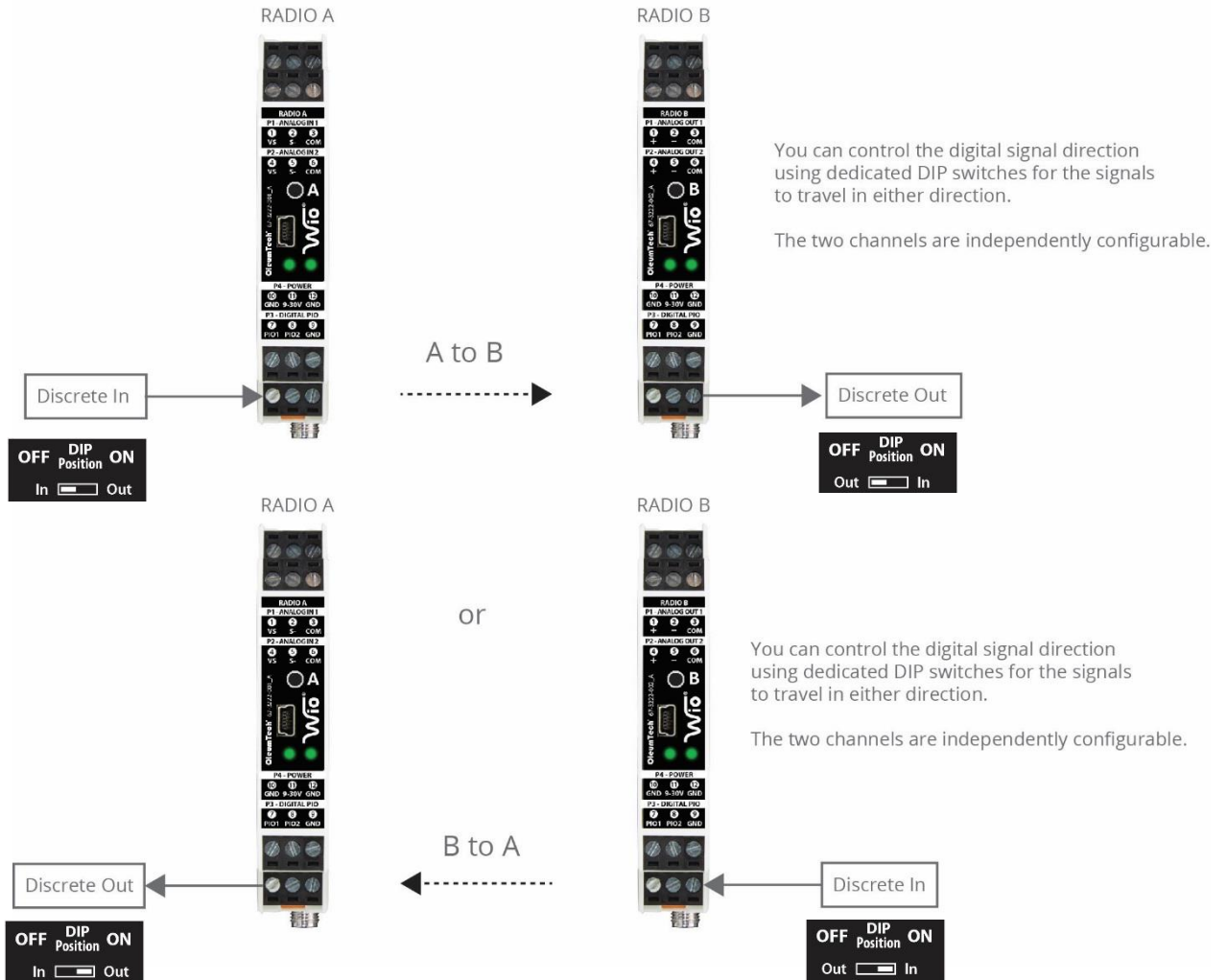

5. HARDWARE AT A GLANCE

RADIO A

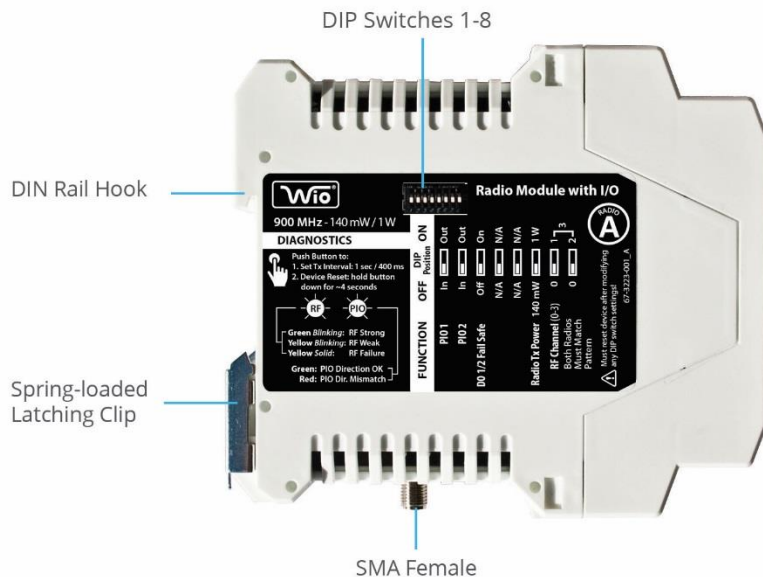

Side View



Front View

RADIO B

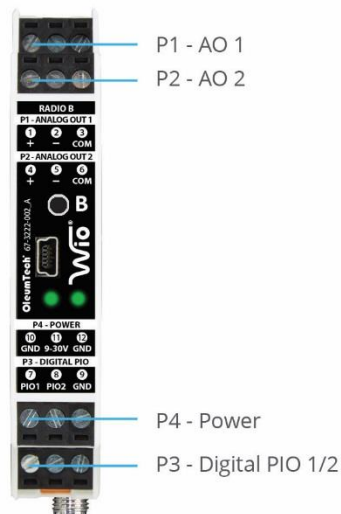

6. RF DIAGNOSTICS AND TRANSMISSION SPEED

A. RF Diagnostics

1. RF health can easily be diagnosed using the left LED located on the front panel.
 - i. Be sure both antennas are installed properly and connected securely to the Radio Modules.
 - ii. Be sure to supply power to both Radio Modules (9-30 Vdc).
 - iii. Use the RF LED to evaluate the signal quality of the RF communication.
 - iv. Performing steps i-iii is the simplest form of doing a site survey prior to installation.
2. When left LED is green, then RF is in good condition.
 - i. Green LED indicates a strong to medium RF signal quality (-40 dB (best) to -94 dB).
 - ii. Speed of flashing LED indicates Tx speed (1 second or 400 ms).
3. When left LED is yellow, it requires attention.
 - i. Flashing yellow indicate a weak RF signal (worse than -94 dB).
 - ii. Solid yellow indicates RF failure.
 1. Triggered when RF communication is lost for 10 consecutive seconds or more.
 2. Automatically drives signal outputs to user-configured fail safe states.
 - iii. When left LED is yellow:
 1. Re-check all cable connections between antenna and Radio Module.
 2. Radio Modules may be out of RF range.
 3. Surrounding area may have many RF interferences and, or obstacles.
 4. If using 900 MHz or 2.4 GHz system, try using a different RF channel.

B. Tx Speed: 1 Second (default) or 400 ms

1. Tx speed is controlled by the Tx Button located on the front of the Radio Module.
 - i. Use a small pin or a screwdriver to press the button to toggle between Tx speeds.
 1. Using faster Tx speed consumes more power.
 - ii. Changing the speed on either Radio Module will update the other Radio Module.

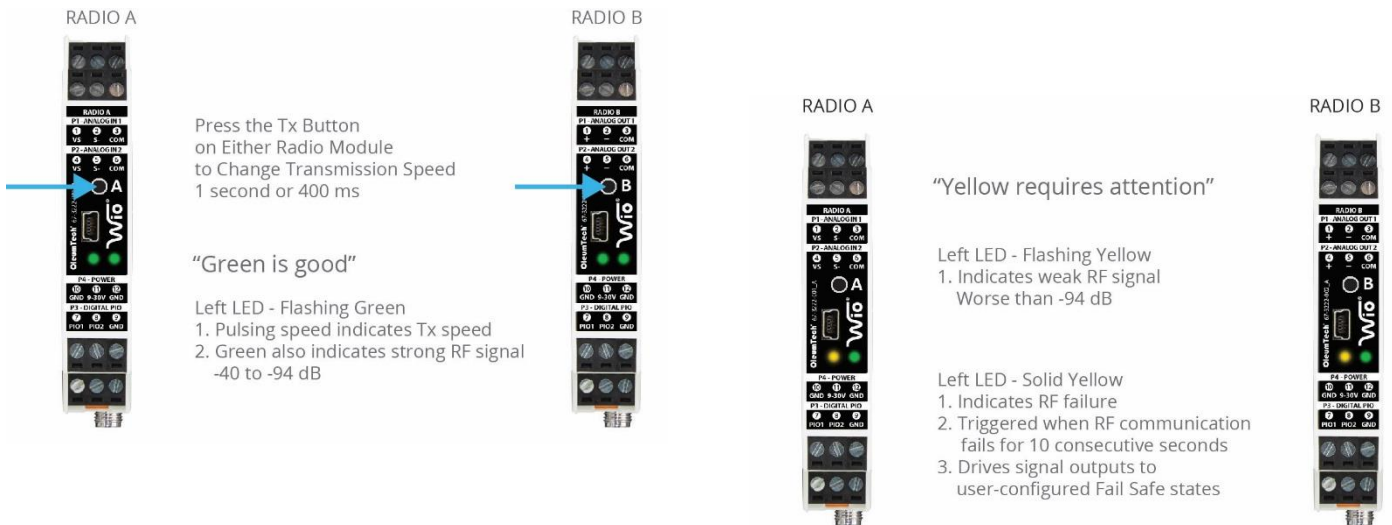

7. DIP SWITCH FUNCTIONS



Device must be reset or power-cycled after modifying any DIP switch settings.



L'appareil doit être réinitialisé ou redémarré après avoir modifié les paramètres du commutateur DIP.



DIP Switches 1 to 8 (left to right)

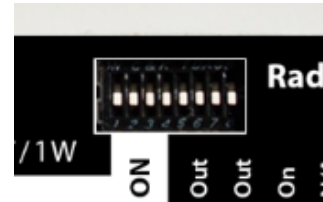

A. Digital PIO Signal Direction

1. Controlled by DIP Switches 1 and 2.
 - i. Factory Default: Radio A = Inputs ; Radio B = Outputs
 - ii. The system supports any combination of signal directions.

RADIO A

FUNCTION	OFF	DIP Position	ON
PIO 1	In		Out
PIO 2	In		Out

RADIO B

FUNCTION	OFF	DIP Position	ON
PIO 1	Out		In
PIO 2	Out		In

*Please note that DIP Switch Input/Output positions are reversed on Radio A and B.

2. Signal direction must always be opposite of each other. Must always be In-Out / Out-In and not In-In / Out-Out (PIO diagnostic LED will flash solid red).



Right LED is lit Green when both PIO directions are setup correctly



Right LED is lit Red when one or both PIO direction is setup is incorrectly

B. Digital Output Fail Safe Modes / RF Health Detection

1. Controlled by DIP Switch 3
 - i. DIP Switch controls fail over operation for both PIO 1 and 2.
 - ii. When Radio communication is lost for 10 seconds or more, the Radio Module will automatically place the outputs to user-configured fail safe states.

RADIO A		DIP Position		RADIO B	
FUNCTION	OFF	ON	FUNCTION	OFF	ON
PIO 1	In	Out	PIO 1	Out	In
PIO 2	In	Out	PIO 2	Out	In
DO 1/2 Fail Safe	Off	On	DO 1/2 Fail Safe	Off	On

2. How to Monitoring RF Health using a PIO channel

- i. To continuously monitor RF health of the system, you can use an available PIO channel for this purpose. You can monitor the RF health from either Radio Module. When RF communication is restored, the operation returns to normal.

t

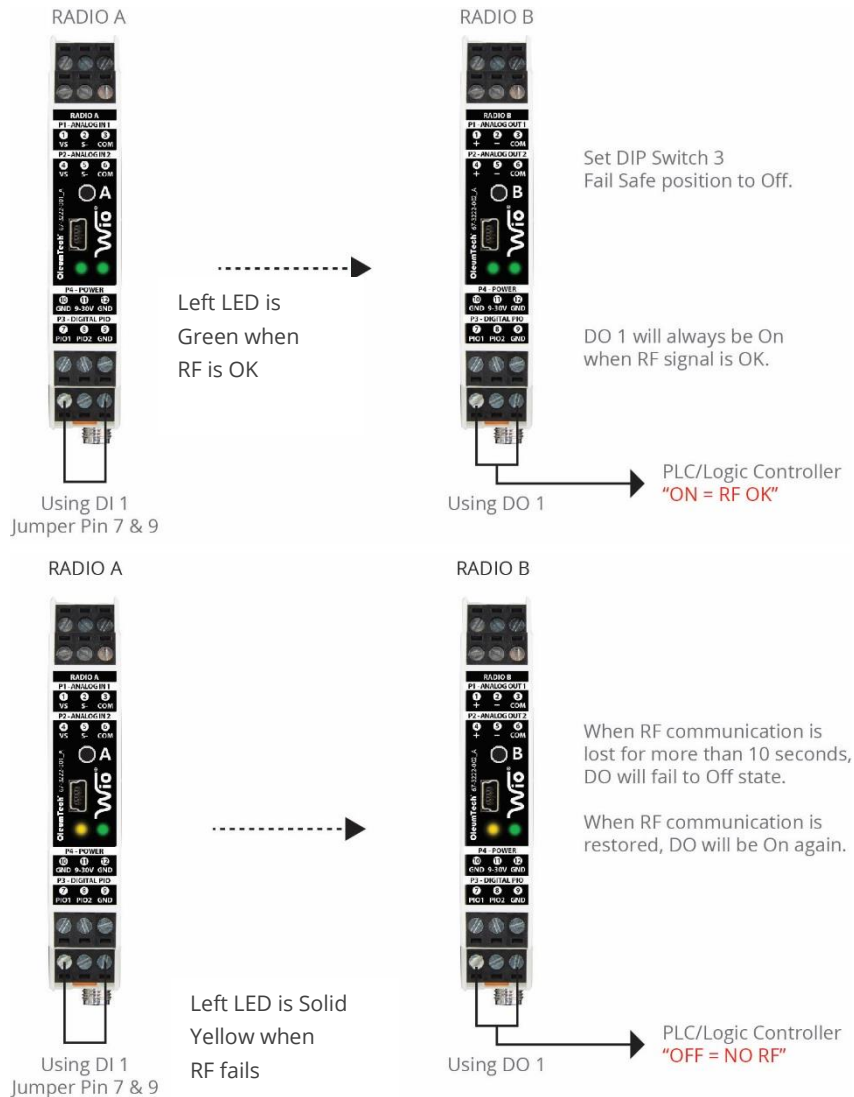

C. Analog Output Fail Safe Modes

1. Radio B only: Controlled by DIP Switches 4 and 5.
2. When Radio communication is lost for 10 seconds or more, the Radio Module will automatically place the outputs to user-configured fail safe values.

RADIO B

FUNCTION	OFF	DIP Position	ON
PI01	Out	<input type="checkbox"/>	In
PI02	Out	<input type="checkbox"/>	In
DO 1/2 Fail Safe	Off	<input type="checkbox"/>	On
AO 1/2 Fail Safe	Last Known Value	<input type="checkbox"/>	<4 mA
		<input type="checkbox"/>	>20 mA

3. Examples of fail safe configurations based on DIP switch positions.

Fail over to Last Know Value (Default)



Fail over to Less than 4 mA



Fail over to Greater than 20 mA



Fail over to Greater than 20 mA



D. RF Transmit Power (900 MHz Only)

1. 900 MHz only: Controlled by DIP Switch 6.
2. 140 mW (default) or 1 W option.
3. Transmit power setting must match on both Radio Modules.

RADIO A			RADIO B		
FUNCTION	OFF	DIP Position ON	FUNCTION	OFF	DIP Position ON
PI0 1	In	<input type="checkbox"/> Out	PI0 1	Out	<input type="checkbox"/> In
PI0 2	In	<input type="checkbox"/> Out	PI0 2	Out	<input type="checkbox"/> In
DO 1/2 Fail Safe	Off	<input type="checkbox"/> On	DO 1/2 Fail Safe	Off	<input type="checkbox"/> On
	N/A	<input type="checkbox"/> N/A	AO 1/2 Fail Safe	Last Known Value	<input type="checkbox"/> <4 mA
	N/A	<input type="checkbox"/> N/A			<input type="checkbox"/> >20 mA
Radio Tx Power	140 mW	<input type="checkbox"/> 1 W	Radio Tx Power	140 mW	<input type="checkbox"/> 1 W

4. 2.4 GHz system's transmit power is fixed at 63 mW.

E. RF Channel Selection (900 MHz and 2.4 GHz Only)

- Radio channel pattern MUST MATCH on both Radio Modules.
- 900 MHz: controlled by DIP Switches 7 and 8 (channels 0 to 3).

RADIO A

FUNCTION	OFF	DIP Position	ON
PI0 1	In	<input type="checkbox"/>	Out
PI0 2	In	<input type="checkbox"/>	Out
DO 1/2 Fail Safe	Off	<input type="checkbox"/>	On
	N/A	<input type="checkbox"/>	N/A
	N/A	<input type="checkbox"/>	N/A
Radio Tx Power	140 mW	<input type="checkbox"/>	1 W
RF Channel (0-3)	0	<input type="checkbox"/>	1
Both Radios Must Match Pattern	0	<input type="checkbox"/>	2

RADIO B

FUNCTION	OFF	DIP Position	ON
PI0 1	Out	<input type="checkbox"/>	In
PI0 2	Out	<input type="checkbox"/>	In
DO 1/2 Fail Safe	Off	<input type="checkbox"/>	On
AO 1/2 Fail Safe	Last Known Value	<input type="checkbox"/>	<4 mA
		<input type="checkbox"/>	>20 mA
Radio Tx Power	140 mW	<input type="checkbox"/>	1 W
RF Channel (0-3)	0	<input type="checkbox"/>	1
Both Radios Must Match Pattern	0	<input type="checkbox"/>	2

- 2.4 GHz: controlled by DIP Switches 6, 7 and 8 (channels 0 to 7)

RADIO A

FUNCTION	OFF	DIP Position	ON
PI0 1	In	<input type="checkbox"/>	Out
PI0 2	In	<input type="checkbox"/>	Out
DO 1/2 Fail Safe	Off	<input type="checkbox"/>	On
	N/A	<input type="checkbox"/>	N/A
	N/A	<input type="checkbox"/>	N/A
RF Channel (0-7)	0	<input type="checkbox"/>	1
Both Radios Must Match Pattern	0	<input type="checkbox"/>	2
	0	<input type="checkbox"/>	4

RADIO B

FUNCTION	OFF	DIP Position	ON
PI0 1	Out	<input type="checkbox"/>	In
PI0 2	Out	<input type="checkbox"/>	In
DO 1/2 Fail Safe	Off	<input type="checkbox"/>	On
AO 1/2 Fail Safe	Last Known Value	<input type="checkbox"/>	<4 mA
		<input type="checkbox"/>	>20 mA
RF Channel (0-7)	0	<input type="checkbox"/>	1
Both Radios Must Match Pattern	0	<input type="checkbox"/>	2
	0	<input type="checkbox"/>	4

- Examples of how to select RF channel/pattern (2.4 GHZ shown) – ID or DIP pattern on both Radio Modules must match:

Channel 0 (Default)	Channel 1	Channel 2																																				
<table border="1"> <tr><td>RF Channel (0-7)</td><td>0</td><td><input type="checkbox"/></td></tr> <tr><td>Both Radios Must Match Pattern</td><td>0</td><td><input type="checkbox"/></td></tr> <tr><td></td><td>0</td><td><input type="checkbox"/></td></tr> </table>	RF Channel (0-7)	0	<input type="checkbox"/>	Both Radios Must Match Pattern	0	<input type="checkbox"/>		0	<input type="checkbox"/>	<table border="1"> <tr><td>RF Channel (0-7)</td><td>0</td><td><input type="checkbox"/></td><td>1</td></tr> <tr><td>Both Radios Must Match Pattern</td><td>0</td><td><input type="checkbox"/></td><td></td></tr> <tr><td></td><td>0</td><td><input type="checkbox"/></td><td></td></tr> </table>	RF Channel (0-7)	0	<input type="checkbox"/>	1	Both Radios Must Match Pattern	0	<input type="checkbox"/>			0	<input type="checkbox"/>		<table border="1"> <tr><td>RF Channel (0-7)</td><td>0</td><td><input type="checkbox"/></td></tr> <tr><td>Both Radios Must Match Pattern</td><td>0</td><td><input type="checkbox"/></td></tr> <tr><td></td><td>0</td><td><input type="checkbox"/></td></tr> <tr><td></td><td>0</td><td><input type="checkbox"/></td></tr> </table>	RF Channel (0-7)	0	<input type="checkbox"/>	Both Radios Must Match Pattern	0	<input type="checkbox"/>		0	<input type="checkbox"/>		0	<input type="checkbox"/>			
RF Channel (0-7)	0	<input type="checkbox"/>																																				
Both Radios Must Match Pattern	0	<input type="checkbox"/>																																				
	0	<input type="checkbox"/>																																				
RF Channel (0-7)	0	<input type="checkbox"/>	1																																			
Both Radios Must Match Pattern	0	<input type="checkbox"/>																																				
	0	<input type="checkbox"/>																																				
RF Channel (0-7)	0	<input type="checkbox"/>																																				
Both Radios Must Match Pattern	0	<input type="checkbox"/>																																				
	0	<input type="checkbox"/>																																				
	0	<input type="checkbox"/>																																				
Channel 3	Channel 5	Channel 6																																				
<table border="1"> <tr><td>RF Channel (0-7)</td><td>0</td><td><input type="checkbox"/></td><td>1</td></tr> <tr><td>Both Radios Must Match Pattern</td><td>0</td><td><input type="checkbox"/></td><td>2</td></tr> <tr><td></td><td>0</td><td><input type="checkbox"/></td><td></td></tr> </table>	RF Channel (0-7)	0	<input type="checkbox"/>	1	Both Radios Must Match Pattern	0	<input type="checkbox"/>	2		0	<input type="checkbox"/>		<table border="1"> <tr><td>RF Channel (0-7)</td><td>0</td><td><input type="checkbox"/></td><td>1</td></tr> <tr><td>Both Radios Must Match Pattern</td><td>0</td><td><input type="checkbox"/></td><td></td></tr> <tr><td></td><td>0</td><td><input type="checkbox"/></td><td>4</td></tr> </table>	RF Channel (0-7)	0	<input type="checkbox"/>	1	Both Radios Must Match Pattern	0	<input type="checkbox"/>			0	<input type="checkbox"/>	4	<table border="1"> <tr><td>RF Channel (0-7)</td><td>0</td><td><input type="checkbox"/></td></tr> <tr><td>Both Radios Must Match Pattern</td><td>0</td><td><input type="checkbox"/></td></tr> <tr><td></td><td>0</td><td><input type="checkbox"/></td></tr> <tr><td></td><td>0</td><td><input type="checkbox"/></td></tr> </table>	RF Channel (0-7)	0	<input type="checkbox"/>	Both Radios Must Match Pattern	0	<input type="checkbox"/>		0	<input type="checkbox"/>		0	<input type="checkbox"/>
RF Channel (0-7)	0	<input type="checkbox"/>	1																																			
Both Radios Must Match Pattern	0	<input type="checkbox"/>	2																																			
	0	<input type="checkbox"/>																																				
RF Channel (0-7)	0	<input type="checkbox"/>	1																																			
Both Radios Must Match Pattern	0	<input type="checkbox"/>																																				
	0	<input type="checkbox"/>	4																																			
RF Channel (0-7)	0	<input type="checkbox"/>																																				
Both Radios Must Match Pattern	0	<input type="checkbox"/>																																				
	0	<input type="checkbox"/>																																				
	0	<input type="checkbox"/>																																				

8. RF SETUP – BEST PRACTICES

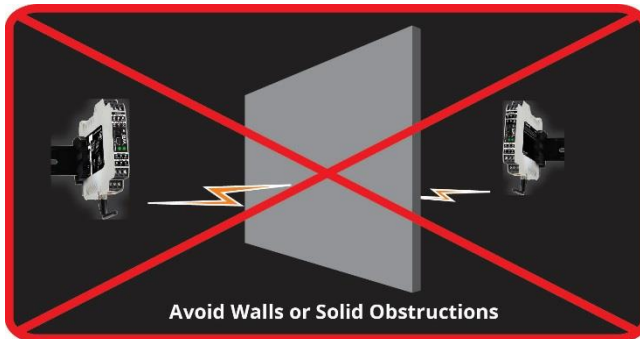
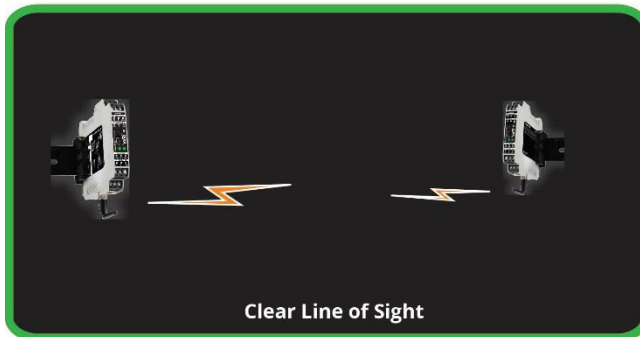

1. Perform a RF survey prior to installation.
2. Use high quality antennas and low loss cables and fittings for achieving the best possible wireless performance.
3. Having a clear line of sight between antennas (Fresnel zone) is ideal for achieving best RF signal quality.
4. When setting up and installing antennas, avoid walls, tall buildings, trees, and other solid obstructions for improving RF signal quality.
5. Install antennas at least 10 ft above ground when possible.
6. When using directional antennas, be sure to point the antennas at each other and be sure to use correct antenna orientation.
7. Be sure to install omni-directional antennas in vertical position or perpendicular to the ground.
8. Be sure that there are no loose connections. Securely tighten all cable connections and wire terminals.
9. Be sure to waterproof all exterior cable connection using high quality sealing tape.
10. Once the WIO System is up and running, use the left LED to diagnose RF health.

9. INSTALLATION

A. Outdoor Installation

1. Install or use existing NEMA-type enclosure.
2. Be sure the WIO® System meets applicable grounding requirements in the enclosure.
3. Install a 35 mm x 7.5 mm DIN rail inside the enclosure.
4. Mount WIO Radio Module onto the DIN rail.

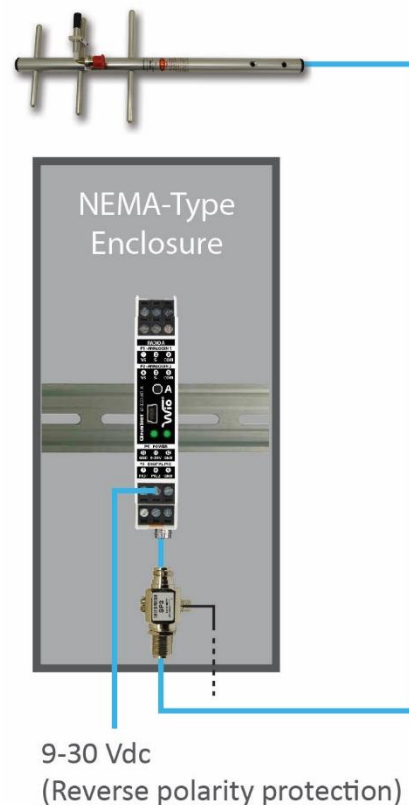

5. Install antenna at least 10 ft above ground (performing a RF site survey prior to installation is highly recommended).

There are various types of antennas including bulkhead, omni, and yagi. Please use the appropriate type for your application.

6. Connect Antenna to Radio Module using appropriate high quality, low loss antenna cables.
7. Connecting a lightning arrester between Radio and Antenna is strongly recommended.
8. Run wires through the bottom of the enclosure and be sure to weather seal any openings.
9. Connect signal wires to the Radio Module.
10. Supply power to the Radio Module: 9-30 Vdc.
11. Repeat above steps for other Radio Module location.

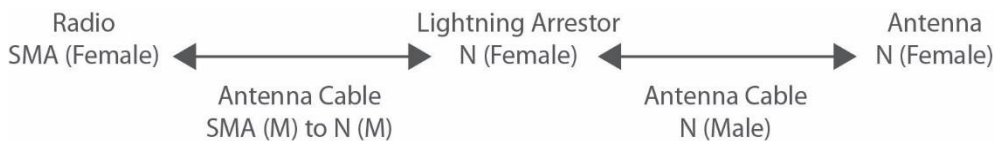

B. How to Detach Radio Module from DIN Rail

WIO® Radio Module can be removed from the din rail by inserting the tip of a flathead screwdriver into removal slot located on the metal latching clip.

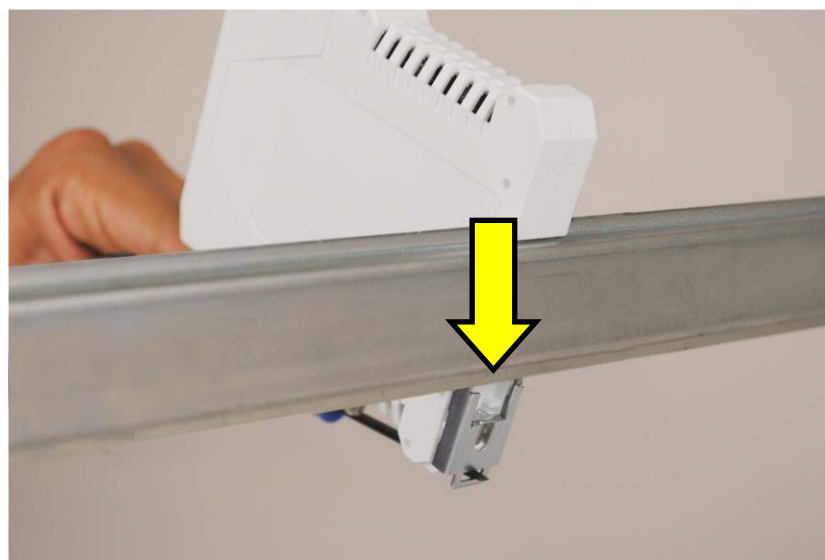
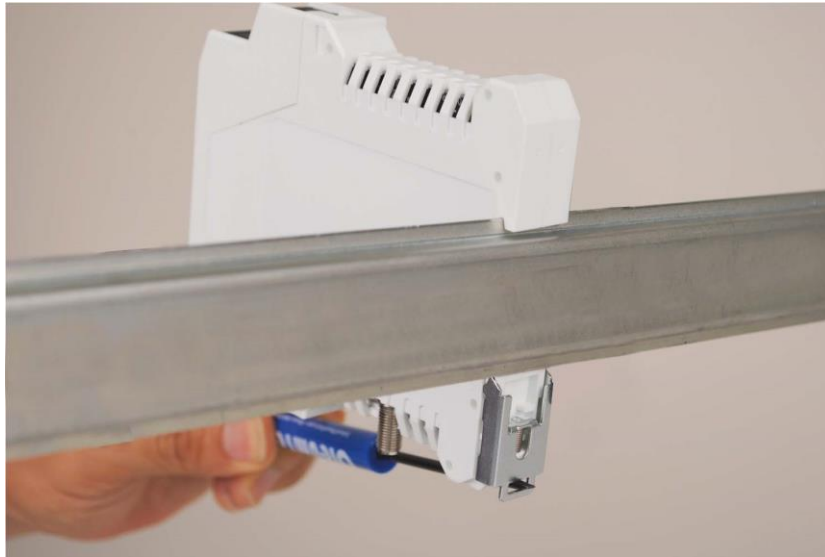

10. WIRING DIAGRAM

A. Power Wiring: 9-30 Vdc (reverse polarity protection)

1. To reset the device, you can power cycle the device or press and hold Tx button down for ~4 seconds until the LEDs are extinguished.
2. Device must be reset after modifying any DIP switch settings.

Note: Main supply voltage fluctuations are not to exceed $\pm 10\%$ for the nominal supply voltage.

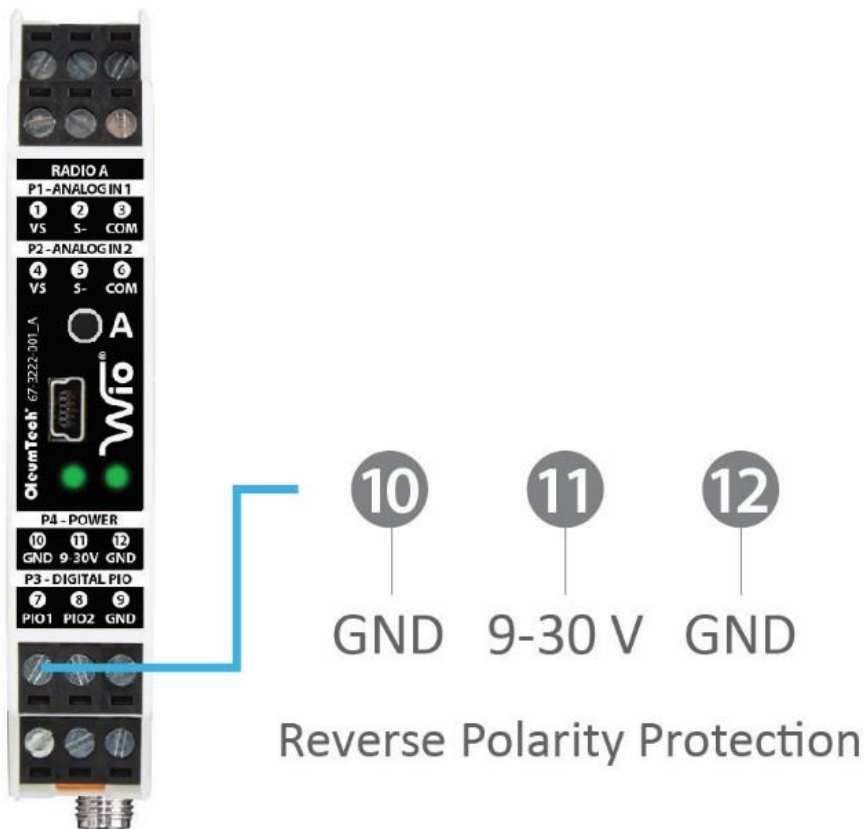

B. Analog 4-20 mA Input (Radio A only)

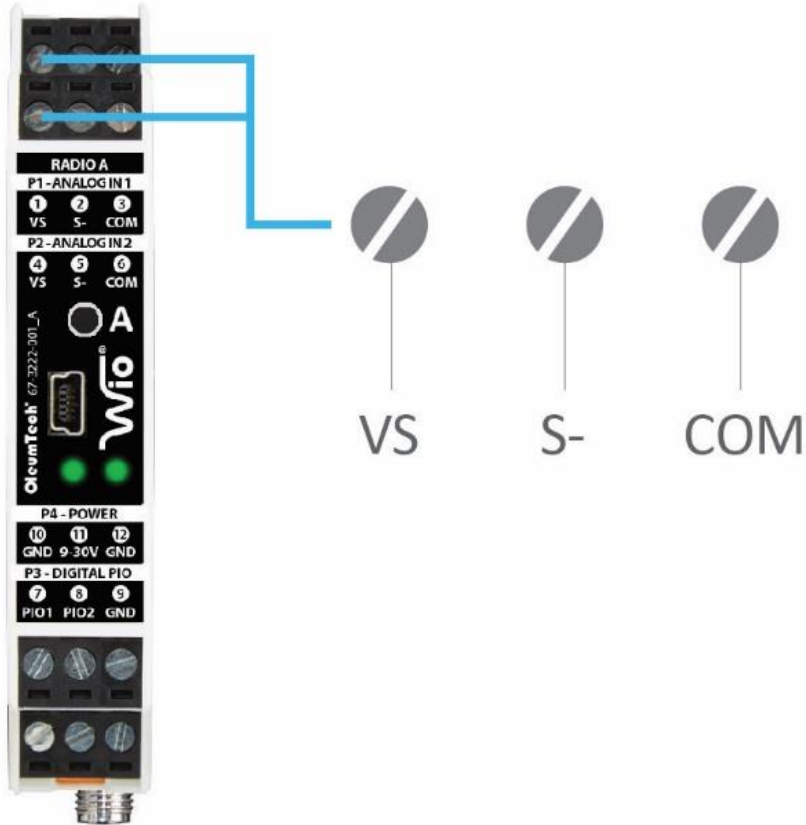

INTERNAL LOOP POWER

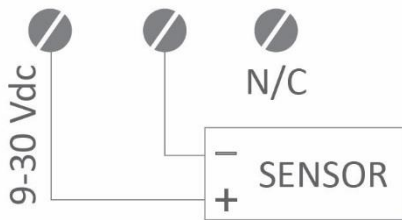

EXTERNAL LOOP POWER

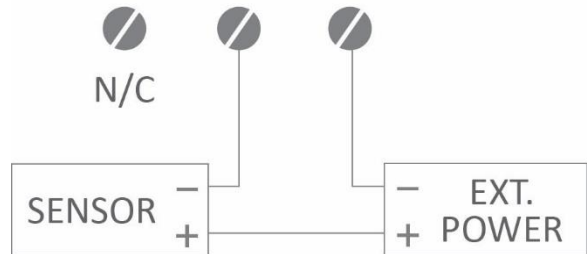

C. Analog 4-20 mA Output Wiring (Radio B only)

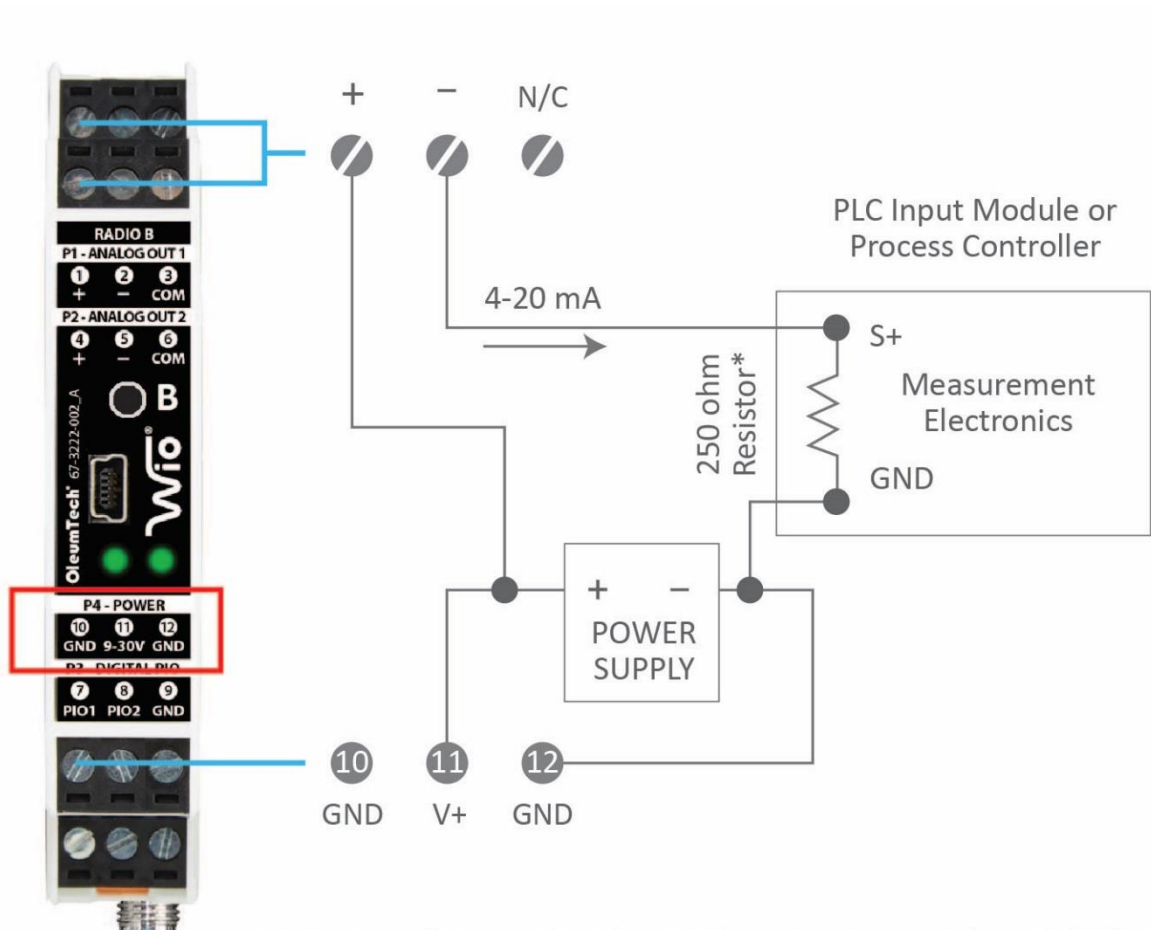

$$VS/\text{External Power (min)} = 7 \text{ Vdc} + \text{Max Current (Amp)} * \text{Rloop}$$

$$\text{Rloop} = \text{Total Loop Impedance}$$

*A 250 ohm Resistor may be required depending on the design of the third-party 4-20 mA input module.

D. Digital/Discrete Input Wiring

1. The PIO DIP switch must be set to Input.



Accepts Dry Contact (Internal 3.3 Vdc Pull-Up), Open-Drain (NPN) and Voltage Level Output (0-30 Vdc Max.)

Input Voltage Threshold:
 Signal "H", $V_i > 1.85$ Vdc
 Signal "L", $V_i < 1.03$ Vdc

Dry Contact

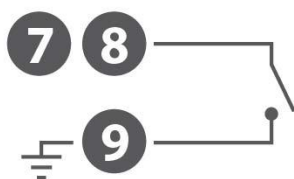

Open-Drain (NPN)

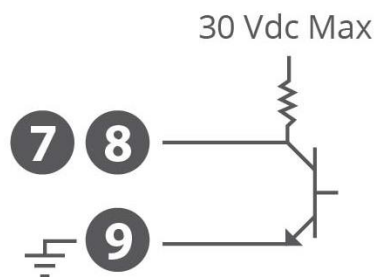

Voltage Level Output

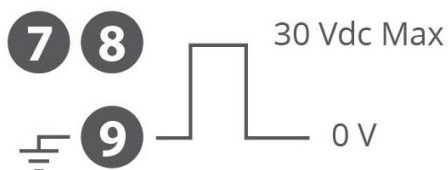

2. Digital/Discrete Output Wiring

- i. The PIO DIP switch must be set to Output.

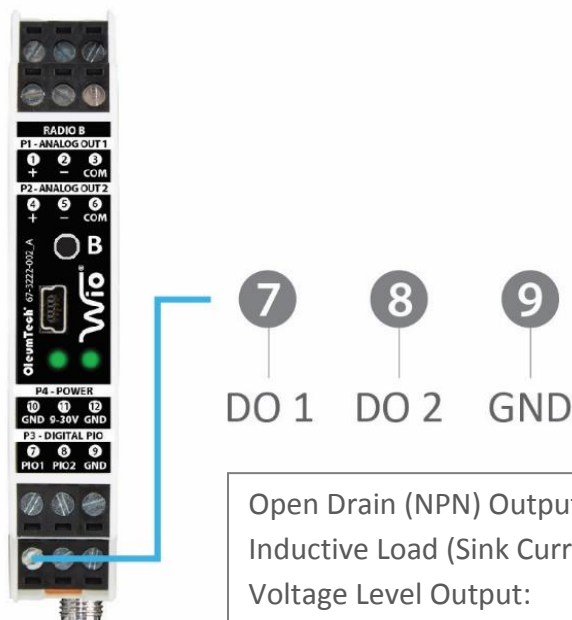

Open Drain (NPN) Outputs:
 Inductive Load (Sink Current): 1 Amp/30 Vdc Max.
 Voltage Level Output:
 Internal Pull-Up:
 Signal "H", $V_o = 3.3 \text{ Vdc}$
 Signal "L", $V_o = 0.2 \text{ Vdc}$

Accepts Optional External Pull-Up, 30 Vdc Max. Requires 10 K Resistor)

Inductive Load



Voltage Level Output (Optional External Pull-Up)

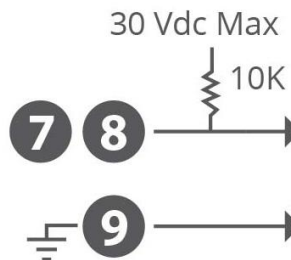

11. SPECIFICATIONS

A. I/O and Hardware Features

Analog 4-20 mA Communication	Uni-Directional (Radio A to B Only)
Digital/Discrete Communication	Bi-Directional (Configurable Using DIP Switches)
DIO Mismatch Indication - Right LED	Green = OK / Red = Mismatch
DIN Rail Mounting Compatibility	35 mm Standard DIN Rail (Direct Mount)
Built-In Mounting Hardware	Spring-Loaded Clip-On System
Wire Gauge	Solid / Stranded (AWG) 28-12 Gauge
Wire Rating (Recommended)	300 V RMS, 80 °C and 300 V, 105 °C
Supply Voltage Range	9 - 30 Vdc (±5 %)
Reverse Polarity Protection	Yes
Power Consumption (Maximum)	Radio A: 230 mA @12 V, 120 mA @24 V Radio B: 260 mA @12 V, 120 mA @24 V
Packaging Dimensions (WxHxD)	4.8 x 5.1 x 2.8-in / 123 x 129 x 72 mm
Net Dimensions	0.7 x 3.9 x 4.5-in / 17.5 x 99 x 114 mm
Packaging Weight	Single: 0.5 lbs / 227 g; Double: 0.8 lbs / 363 g
Net Weight (Single Radio)	0.3 lbs / 136 g
Warranty	2-Year Limited

B. Radio Features

Communication Type	Point-to-Point Wireless I/O Communication System
Radio Frequency (RF)	902-928 MHz 915-928 MHz 2.4 GHz
RF Security	128-bit AES Encryption
Antenna Connector Type	SMA (Female Connector)
Default Transmission Speed / Response Time	1 Second
Turbo Transmission Speed / Response Time	400 ms
Line of Sight Maximum RF Range	900 MHz: 40 Miles (64.4 Km) / 2.4 GHz: 4.3 Miles (7 Km)
RF Transmit Power	900 MHz: 140 mW/1 W (22 or 30 dBm - DIP Switch Selectable) 915 MHz: 140 mW/1 W (22 or 30 dBm - DIP Switch Selectable) 2.4 GHz: 63 mW (18 dBm) 2.4 GHz Low Power: 10 mW (10 dBm)
Receiver Sensitivity	900 MHz: -101 dBm / 2.4 GHz: -100 dBm
Spread Spectrum	900 MHz: FHSS / 2.4 GHz DSSS
RF Link Indication - Left LED	Green = OK / Solid Yellow = Failed
RF Timeout Trigger	10 Seconds
RF Response Time	Flashing Normal (1 sec) / Flashing Fast (250ms)
RF Signal Quality	Flashing Green = Strong / Flashing Yellow = Weak

C. Analog Inputs (Radio A Only)

2x Analog Inputs	4 mA to 20 mA (16-bit Resolution)
Accuracy	< 0.2 % of Full Scale
Internal Loop Power	9-30 Vdc
AI Input Impedance (loop)	250 Ohm

D. Analog Outputs (Radio B Only)

2x Analog Outputs	4 mA to 20 mA (16-bit Resolution)
AO Terminal Voltage Range	10 Vdc Min. / 31.5 Vdc Max.
RF Fail-Safe Output Modes	Last Known Value (Def.), <4 mA, >20 mA (DIP)

E. Digital Programmable I/O (PIO)

IO Channel Count	2x Available on Each Radio Module
Signal Direction	Any Direction, Any Combination (If A = In; B = Out) Signal Direction Controlled via DIP Switches
Digital Inputs	Accepts Dry Contact, Open-Drain (NPN) and Level Output (0-30 Vdc Max.)
Input Voltage Threshold	Signal "H", Vi > 1.85 Vdc Signal "L", Vi < 1.03 Vdc
Output Rating	Inductive Load (Sink Current): 1 Amp/30 Vdc Max. Internal Pull-Up: Signal "H", Vo = 3.3 Vdc Signal "L", Vo = 0.2 Vdc Voltage Level Output: (Accepts Optional Ext. Pull-Up, 30 Vdc Max. Requires 10 K Resistor)
RF Fail-Safe Output Modes	On or Off (DIP Switch Controlled)

F. Safety and Compliance

Storage/Operating Temperature	-40 °C to 80 °C / -40 °F to 176 °F
Humidity (Storage/Operating)	Up to 99 %, Non-condensing
Protection Degree	Pollution Degree 2
Ingress Protection	IP20 / Plastic
RF Emissions	FCC Part 15 (USA), IC ICES-003 (Can), ACMA (Aus) AS/NZS CISPR 32 (Aus), EN55032 & EN55024 (EU)
Classification	Ordinary Locations (Non-hazardous)
Safety	CAN/CSA-C22.2 No. 61010-1-12 CAN/CSA-IEC 61010-2-14 UL 61010-1, UL 61010-2-201-14 Equipment Class II, Pollution Degree 2 Not intended for use in hazardous locations

Note: Main supply voltage fluctuations are not to exceed ± 10 % fo the nominal supply voltage.

12. CONDITIONS OF ACCEPTABILITY

- A. Equipment is only to be installed by manufacturer trained personnel.
- B. If at any time there is a conflict between the system safety provisions and any relevant local (national or regional) requirements, the local requirements always take precedence.
- C. This product is NOT intended for use in hazardous locations.
- D. Equipment has only been tested for electrical safety. No evaluation of functional safety and performance characteristics has been conducted.
- E. This is OPEN type equipment that must be installed within a suitable end-use enclosure that requires a tool to access. The suitability of the enclosure is subject to investigation by the local Authority Having Jurisdiction at the time of installation.
- F. Wiring to or from this equipment, which enters or leaves the system enclosure, must utilize wiring methods suitable for Class II, as appropriate for the installation.

13. WARRANTY

- A. OleumTech warrants that goods described herein and manufactured by OleumTech are free from defects in material and workmanship for two (2) years from the date of shipment. Batteries are expressly excluded from this warranty. Battery life and replacement batteries may be warranted under separate agreement depending on specific customer needs and applications.
- B. OleumTech warrants that goods repaired by it pursuant to the warranty are free from defects in material and workmanship for a period to the end of the original warranty or ninety (90) days from the date of delivery of repaired goods, whichever is longer.
- C. Warranties on goods not manufactured by OleumTech are expressly limited to the terms of the warranties given by the manufacturer of such goods.
- D. All warranties are void in the event that the goods or systems or any part thereof are (i) misused, abused or otherwise damaged, (ii) repaired, altered or modified without OleumTech's consent, (iii) not installed, maintained and operated in strict compliance with instructions furnished by OleumTech, (iv) worn, injured or damaged from abnormal or abusive use in service time, (v) subjected to acts of God, or extreme weather phenomenon including, but not limited to, flood, lightning, tornado or hurricane, or (vi) intentional acts including, but not limited to vandalism, sabotage, explosion or acts of terrorism.
- E. THESE WARRANTIES ARE EXPRESSLY IN LIEU OF ALL OTHER WARRANTIES EXPRESSED OR IMPLIED (INCLUDING WITHOUT LIMITATION WARRANTIES AS TO MERCHANTABILITY AND FITNESS FOR A PARTICULAR PURPOSE), AND NO WARRANTIES, EXPRESSED OR IMPLIED, NOR ANY REPRESENTATIONS, PROMISES, OR STATEMENTS HAVE BEEN MADE BY OLEUMTECH UNLESS ENDORSED HEREIN IN WRITING. FURTHER, THERE ARE NO WARRANTIES, WHICH EXTEND BEYOND THE DESCRIPTION OF THE FACE HEREOF. ANY WARRANTIES BEYOND THOSE SET FORTH HEREIN MUST COME DIRECTLY FROM OLEUMTECH.

14. REVISION HISTORY

Rev A

New Document

Rev B

Revised 4-20 mA output wiring diagram to support using a single power source
Updated photos for Radio Module removal from a DIN rail

Rev C

Revised cover page.
Added 868 MHz max RF range to technical specifications.

Rev D

Revised 2.4 GHz RF range.
Revised digital input wiring diagram.
Revised digital output wiring diagram.
Revised digital input and output specifications.
Removed revision history table from section 1.
Radio specifications updated with 915 MHz data.

Rev D

Removed mentions of 868 MHz option.
Revised system overview section.

OleumTech®

19762 Pauling Way
Foothill Ranch, CA. 92610
Phone: 866.508.8586 • 949.305.9009
Fax: 949.305.9010
<https://oleumtech.com>
<https://wio.oleumtech.com>

OleumTech has made a good faith effort to ensure the accuracy of the information in this document and disclaims the implied warranties of merchantability and fitness for a particular purpose and makes no express warranties, except as may be stated in its written agreement with and for its customers.

OleumTech shall not be held liable to anyone for any indirect, special or consequential damages due to omissions or errors. The information and specifications in this document are subject to change without notice.

Copyright © 2019. All Rights Reserved.

OleumTech and WIO are registered trademarks of OleumTech Corporation.

Other trademarks and registered trademarks are the property of their respective owners.

Specifications, design, product descriptions, and availability subject to change without notice.