

inRAx



MVI56-FLN

ControlLogix Platform

FA Control Network Communication
Module

User Manual

June 06, 2008



Please Read This Notice

Successful application of this module requires a reasonable working knowledge of the Rockwell Automation ControlLogix hardware, the MVI56-FLN Module and the application in which the combination is to be used. For this reason, it is important that those responsible for implementation satisfy themselves that the combination will meet the needs of the application without exposing personnel or equipment to unsafe or inappropriate working conditions.

This manual is provided to assist the user. Every attempt has been made to ensure that the information provided is accurate and a true reflection of the product's installation requirements. In order to ensure a complete understanding of the operation of the product, the user should read all applicable Rockwell Automation documentation on the operation of the Rockwell Automation hardware.

Under no conditions will ProSoft Technology be responsible or liable for indirect or consequential damages resulting from the use or application of the product.

Reproduction of the contents of this manual, in whole or in part, without written permission from ProSoft Technology is prohibited.

Information in this manual is subject to change without notice and does not represent a commitment on the part of ProSoft Technology Improvements and/or changes in this manual or the product may be made at any time. These changes will be made periodically to correct technical inaccuracies or typographical errors.

Warnings

UL Warnings

- A** Warning - Explosion Hazard - Substitution of components may impair suitability for Class I, Division 2.
- B** Warning - Explosion Hazard - When in Hazardous Locations, turn off power before replacing or rewiring modules.
Warning - Explosion Hazard - Do not disconnect equipment unless power has been switched off or the area is known to be nonhazardous.
- C** Suitable for use in Class I, division 2 Groups A, B, C and D Hazardous Locations or Non-Hazardous Locations.

ATEX Warnings and Conditions of Safe Usage:

Power, Input, and Output (I/O) wiring must be in accordance with the authority having jurisdiction

- A** Warning - Explosion Hazard - When in hazardous locations, turn off power before replacing or wiring modules.
- B** Warning - Explosion Hazard - Do not disconnect equipment unless power has been switched off or the area is known to be non-hazardous.
- C** These products are intended to be mounted in an IP54 enclosure. The devices shall provide external means to prevent the rated voltage being exceeded by transient disturbances of more than 40%. This device must be used only with ATEX certified backplanes.
- D** DO NOT OPEN WHEN ENERGIZED.

Electrical Ratings

- Backplane Current Load: 800 mA @ 5 V DC; 3mA @ 24V DC
- Operating Temperature: 0 to 60°C (32 to 140°F)
- Storage Temperature: -40 to 85°C (-40 to 185°F)
- Shock: 30g Operational; 50g non-operational; Vibration: 5 g from 10 to 150 Hz
- Relative Humidity 5% to 95% (non-condensing)
- All phase conductor sizes must be at least 1.3 mm(squared) and all earth ground conductors must be at least 4mm(squared).

Markings:



II 3 G 0C <=Ta<= 60C EEx nA IIC T4 DEMKO 07ATEX0710717X

Battery Life Advisory

All modules in the MVI series use a rechargeable Lithium Vanadium Pentoxide battery to backup the 512K SRAM memory, real-time clock, and CMOS. The battery should last for the life of the module.

The module must be powered for approximately twenty hours before it becomes fully charged. After it is fully charged, the battery provides backup power for the CMOS setup and configuration data, the real-time clock, and the 512K SRAM memory for approximately 21 days.

Before you remove a module from its power source, ensure that the battery within the module is fully charged. A fully charged battery will hold the BIOS settings (after being removed from its power source) for a limited number of days. When the battery is fully discharged, the module will revert to the default BIOS settings.

Note: The battery is not user replaceable.

ProSoft® Product Documentation

In an effort to conserve paper, ProSoft Technology no longer includes printed manuals with our product shipments. User Manuals, Datasheets, Sample Ladder Files, and Configuration Files are provided on the enclosed CD and are available at no charge from our web site: <http://www.prosoft-technology.com>

Printed documentation is available for purchase. Contact ProSoft Technology for pricing and availability.

Asia Pacific: +603.7724.2080

Europe, Middle East, Africa: +33.5.34.36.87.20

Latin America: +1.281.298.9109

North America: +1.661.716.5100

Your Feedback Please

We always want you to feel that you made the right decision to use our products. If you have suggestions, comments, compliments or complaints about the product, documentation or support, please write or call us.

ProSoft Technology

1675 Chester Avenue, Fourth Floor

Bakersfield, CA 93301

+1 (661) 716-5100

+1 (661) 716-5101 (Fax)

<http://www.prosoft-technology.com>

Copyright © ProSoft Technology, Inc. 2000 - 2008. All Rights Reserved.

MVI56-FLN User Manual

June 06, 2008

PSFT.FLN.MVI56.UM.08.06.06

ProSoft Technology®, ProLinx®, inRAx®, ProTalk® and RadioLinx® are Registered Trademarks of ProSoft Technology, Inc.

Contents

PLEASE READ THIS NOTICE.....	2
Warnings.....	2
Battery Life Advisory.....	3
ProSoft® Product Documentation.....	3
Your Feedback Please.....	4
GUIDE TO THE MVI56-FLN USER MANUAL.....	9
1 START HERE.....	11
1.1 System Requirements.....	12
1.2 Package Contents.....	13
1.3 Install ProSoft Configuration Builder Software.....	13
1.4 Install the Module in the Rack.....	14
1.5 Connect your PC to the Processor.....	16
1.5.1 Sample Ladder Logic.....	17
1.6 Download the Sample Program to the Processor.....	20
1.6.1 Configuring RSLinx.....	21
1.7 Connect your PC to the Module.....	23
1.8 Configure the MVI56-FLN Module.....	23
1.8.1 ProSoft Configuration Builder.....	24
1.8.2 Configure Area 1 and Area 2.....	28
1.8.3 Configure the General Parameters.....	30
1.8.4 Data Mapping Functionality.....	30
1.8.5 Configure the Node Number.....	35
1.8.6 Ethernet Configuration.....	35
1.9 Download the Project to the Module.....	36
1.10 Cable Connections.....	37
1.10.1 Ethernet Connection.....	37
1.10.2 RS-232 Configuration/Debug Port.....	38
1.10.3 DB9 to RJ45 Adaptor (Cable 14).....	40
1.11 Setup the FL/ET-T-V2 Module.....	41
1.11.1 Set Operation Mode Switch.....	41
1.12 FL/ET-V2 Configuration with PCwin.....	42
1.12.1 Specify I/O Module ID Code.....	42
1.12.2 Setup the FL/ET-V2 Link Parameters.....	43
1.13 Download the Project.....	47
1.14 Connect the MVI56-FLN Module to the FL/ET-T-V2.....	47
1.15 Verifying Communication.....	47
1.15.1 Using the Configuration/Debug Port.....	47
1.15.2 The Configuration/Debug Menu.....	48
1.15.3 Using the Module Debug Menu.....	49
1.15.4 Checking Status through ControlLogix Controller Tags.....	54
1.15.5 Transferring Data.....	61
2 DIAGNOSTICS AND TROUBLESHOOTING.....	67
2.1 Required Hardware.....	67
2.2 The Configuration/Debug Menu.....	68
2.2.1 Using the Diagnostic Window in ProSoft Configuration Builder.....	68
2.2.2 Navigation.....	69
2.3 Basic Ethernet.....	70
2.4 LED Status Indicators.....	70
2.5 Ethernet LED Indicators.....	71
2.6 Troubleshooting.....	71

2.6.1	Own-Node Status information	71
3	REFERENCE	73
3.1	Product Specifications	73
3.1.1	Product Description	73
3.1.2	Features	73
3.1.3	Functional Specifications	74
3.2	Functional Overview	75
3.2.1	About FL-net Protocol	75
3.2.2	Module Power Up	81
3.2.3	Backplane Data Transfer	81
3.2.4	Data Flow between Module and Processor	86
3.3	Implementation of FL-net	87
3.3.1	Information Tables	87
3.3.2	Lower Layer Protocol	95
3.4	FL-net Node Configuration Parameters	96
3.4.1	Node Number	96
3.4.2	Top address and data size of common memory transmitting area	96
3.4.3	Node name (equipment name)	96
3.4.4	Token monitoring time	97
3.4.5	Allowable minimum frame interval	97
3.4.6	Allowable refresh cycle time	97
3.4.7	Memory Resources	98
3.5	FL-net Protocol and network	98
3.5.1	Understanding the Basics of FL-net	98
3.5.2	Data Frame ID of FL-net	100
3.5.3	Message Transmissions	101
3.5.4	Message Transmission Function	102
3.5.5	Data volume and number of frames	104
3.5.6	Network Management	105
3.5.7	Masterless Transmission Management	106
3.5.8	FA link protocol	108
3.6	Error and Status Data	109
3.6.1	Status Data	109
3.7	FL-net Device Profile for MVI56-FLN Module	110
3.7.1	Text Notation of Profile	110
3.8	Communications Management Tables	113
3.8.1	Own Node Management Table	113
3.8.2	Participating Node Management Table	114
3.8.3	Network Management Table	114
3.8.4	Cyclic Transmission	115
3.8.5	Volume of Transmission Data	115
3.9	State Transition Diagram	115
3.9.1	A. State definitions	115
3.9.2	B. Initialization monitoring	117
3.9.3	C. Network initialization	119
3.9.4	D. Halfway joining initialization	120
3.9.5	E. Waiting for token	121
3.9.6	F. Token holding	122
3.9.7	G. Message transmission state transition	123
3.9.8	H. Message reception state transition	124
3.10	Glossary	125
4	SUPPORT, SERVICE & WARRANTY	127
4.1	How to Contact Us: Sales and Support	127
4.2	Return Material Authorization (RMA) Policies and Conditions	128
4.2.1	All Product Returns	128
4.3	Procedures for Return of Units Under Warranty	129
4.4	Procedures for Return of Units Out of Warranty	130
4.4.1	Un-repairable Units	130
4.4.2	Purchasing Warranty Extension	131

4.5 LIMITED WARRANTY	131
4.5.1 What Is Covered By This Warranty	131
4.5.2 What Is Not Covered By This Warranty	132
4.5.3 DISCLAIMER REGARDING HIGH RISK ACTIVITIES	133
4.5.4 DISCLAIMER OF ALL OTHER WARRANTIES	133
4.5.5 LIMITATION OF REMEDIES**	133
4.5.6 Time Limit for Bringing Suit.....	133
4.5.7 No Other Warranties.....	134
4.5.8 Intellectual Property	134
4.5.9 Additional Restrictions Relating To Software And Other Intellectual Property	134
4.5.10 Allocation of risks.....	134
4.5.11 Controlling Law and Severability	135
INDEX	137

Guide to the MVI56-FLN User Manual

Function		Section to Read	Details
Introduction (Must Do)	→	Start Here (page 11)	This Section introduces the customer to the module. Included are: package contents, system requirements, hardware installation, and basic configuration.
Verify Communication, Diagnostic and Troubleshooting	→	Verifying Communication (page 47) Diagnostics and Troubleshooting (page 67)	This section describes how to verify communications with the network. Diagnostic and Troubleshooting procedures.
Reference Product Specifications Functional Overview Glossary	→	Reference (page 73) Functional Overview (page 75) Product Specifications (page 73)	These sections contain general references associated with this product, Specifications, and the Functional Overview.
Support, Service, and Warranty Index	→	Support, Service and Warranty (page 127)	This section contains Support, Service and Warranty information. Index of chapters.

1 Start Here

In This Chapter

❖ System Requirements	12
❖ Package Contents	13
❖ Install ProSoft Configuration Builder Software.....	13
❖ Install the Module in the Rack	14
❖ Connect your PC to the Processor	16
❖ Download the Sample Program to the Processor.....	20
❖ Connect your PC to the Module	23
❖ Configure the MVI56-FLN Module.....	23
❖ Download the Project to the Module.....	36
❖ Cable Connections	37
❖ Setup the FL/ET-T-V2 Module.....	41
❖ FL/ET-V2 Configuration with PCwin	42
❖ Download the Project	47
❖ Connect the MVI56-FLN Module to the FL/ET-T-V2	47
❖ Verifying Communication.....	47

The purpose of this section of the User Manual is to show the MVI56-FLN functionality through a real application. For this application, the MVI56-FLN communicates with an FL/ET-T-V2 module (Toyoda) that transfers the data to the TOYODA PC3JG-P processor located on the same rack.

For this example, the MVI56-FLN node address is 40, and the FL/ET-T-V2 module node address is 10.

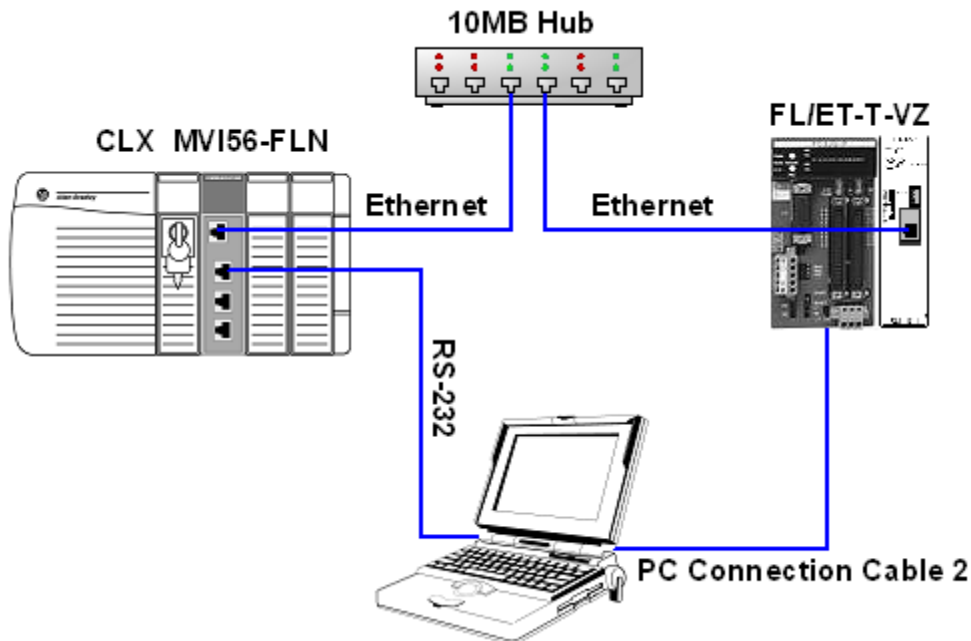

1.1 System Requirements

The MVI56-FLN module requires the following minimum hardware and software components:

- Rockwell Automation ControlLogix processor, with compatible power supply and one free slot in the rack, for the MVI56-FLN module. The module requires 800mA of available power.
- Rockwell Automation RSLogix 5000 programming software version 2.51 or higher.
- Rockwell Automation RSLinx communication software
- Pentium® II 450 MHz minimum. Pentium III 733 MHz (or better) recommended
- Supported operating systems:
 - Microsoft Windows XP Professional with Service Pack 1 or 2
 - Microsoft Windows 2000 Professional with Service Pack 1, 2, or 3
 - Microsoft Windows Server 2003
- 128 Mbytes of RAM minimum, 256 Mbytes of RAM recommended
- 100 Mbytes of free hard disk space (or more based on application requirements)
- 256-color VGA graphics adapter, 800 x 600 minimum resolution (True Color 1024 × 768 recommended)
- CD-ROM drive

1.2 Package Contents

The following components are included with your MVI56-FLN module, and are all required for installation and configuration.

Important: Before beginning the installation, please verify that all of the following items are present.

Qty.	Part Name	Part Number	Part Description
1	MVI56-FLN Module	MVI56-FLN	FA Control Network Communication Module
1	Cable	Cable #15, RS232 Null Modem	For RS232 Connection to the CFG Port
1	Cable	RJ45 to DB9 Male Adapter	For DB9 Connection to Module's Port
1	inRAX Solutions CD		Contains sample programs, utilities and documentation for the MVI56-FLN module.

If any of these components are missing, please contact ProSoft Technology Support for replacement parts.

1.3 Install ProSoft Configuration Builder Software

You must install the ProSoft Configuration Builder (PCB) software in order to configure the MVI56-FLN module. You can always get the newest version of ProSoft Configuration Builder from the ProSoft Technology web site.

To install ProSoft Configuration Builder from the ProSoft Web Site

- 1 Open your web browser and navigate to <http://www.prosoft-technology.com/pcb>
- 2 Click the **Download Here** link to download the latest version of ProSoft Configuration Builder.
- 3 Choose "Save" or "Save File" when prompted. The following illustrations show the file download prompt for two of the most common web browsers.

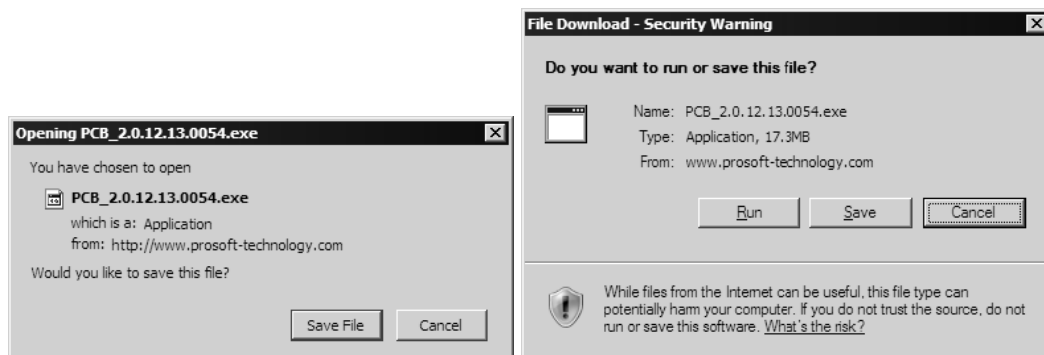

- 4 Make a note of the location where you saved the file, for example "Desktop", or "My Documents", so you can start the installation program.

- 5 When the download is complete, locate and open the file, and then follow the instructions on your screen to install the program.

If you do not have access to the Internet, you can install ProSoft Configuration Builder from the ProSoft Solutions CD-ROM, included in the package with your MVI56-FLN module.

To install ProSoft Configuration Builder from the CD-ROM

- 1 Insert the ProSoft Solutions CD-ROM into the CD drive of your PC. Wait for the startup screen to appear.
- 2 On the startup screen, click *Product Documentation*. This action opens an explorer window.
- 3 Click to open the *Utilities* folder. This folder contains all of the applications and files you will need to set up and configure your module.
- 4 Double-click the *ProSoft Configuration Builder Setup* program and follow the instructions on your screen to install the software on your PC.

Note: Many of the configuration and maintenance procedures use files and other utilities on the CD-ROM. You may wish to copy the files from the Utilities folder on the CD-ROM to a convenient location on your hard drive.

1.4 Install the Module in the Rack

If you have not already installed and configured your ControlLogix processor and power supply, please do so before installing the MVI56-FLN module. Refer to your Rockwell Automation product documentation for installation instructions.

Warning: You must follow all safety instructions when installing this or any other electronic devices. Failure to follow safety procedures could result in damage to hardware or data, or even serious injury or death to personnel. Refer to the documentation for each device you plan to connect to verify that suitable safety procedures are in place before installing or servicing the device.

After you have checked the placement of the jumpers, insert MVI56-FLN into the ControlLogix chassis. Use the same technique recommended by Rockwell Automation to remove and install ControlLogix modules.

Warning: When you insert or remove the module while backplane power is on, an electrical arc can occur. This could cause an explosion in hazardous location installations. Verify that power is removed or the area is non-hazardous before proceeding. Repeated electrical arcing causes excessive wear to contacts on both the module and its mating connector. Worn contacts may create electrical resistance that can affect module operation.

- 1 Turn power OFF.

- 2 Align the module with the top and bottom guides, and slide it into the rack until the module is firmly against the backplane connector.

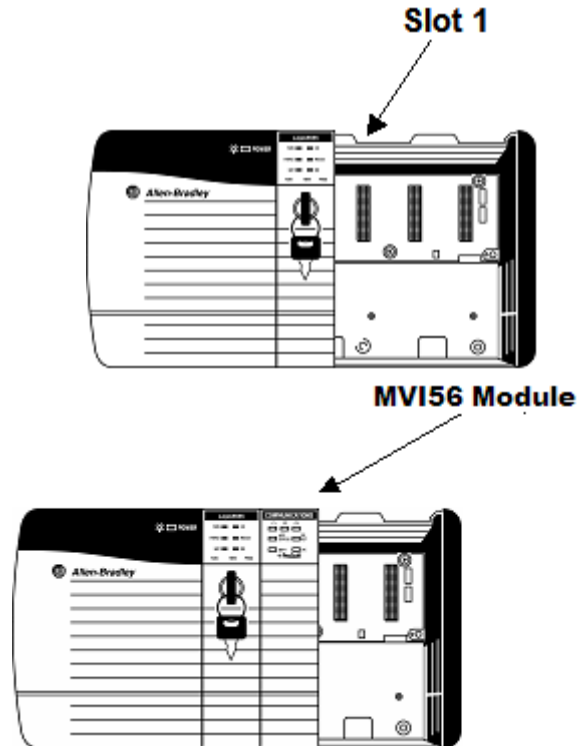

- 3 With a firm but steady push, snap the module into place.
- 4 Check that the holding clips on the top and bottom of the module are securely in the locking holes of the rack.
- 5 Make a note of the slot location. You will need to identify the slot in which the module is installed in order for the sample program to work correctly. Slot numbers are identified on the green circuit board (backplane) of the ControlLogix rack.
- 6 Turn power ON.

Note: If you insert the module improperly, the system may stop working, or may behave unpredictably.

Note: If you are installing MVI56-FLN with other modules connected to the PCI bus, the peripheral modules will not have holding clips. Make sure all of the modules are aligned with their respective slots before you snap them into place.

1.5 Connect your PC to the Processor

- 1 Connect the right-angle connector end of the cable to your controller at the communications port.

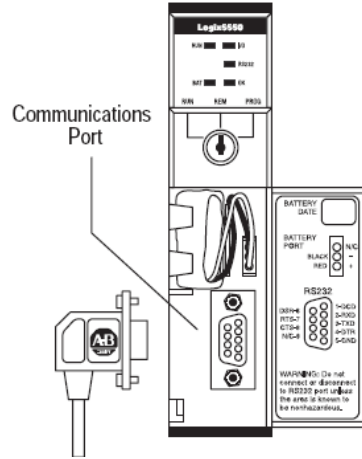

- 2 Connect the straight connector end of the cable to the serial port on your computer.

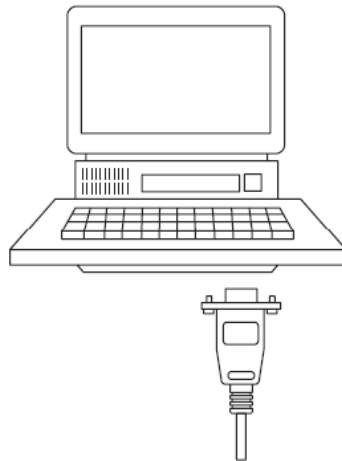

1.5.1 Sample Ladder Logic

Important: You must download the sample ladder to the ControlLogix processor, otherwise the module will be unable to establish communication with the processor.

If you see the message

"Waiting for connection to processor..."

when you connect to the configuration/debug port on the MVI56-FLN module using HyperTerminal, connect to the processor with RSLogix and download the sample ladder logic to the processor before continuing.

Open the Sample Ladder Logic in RSLogix

The sample program for your MVI56-FLN module includes custom tags, data types and ladder logic for data I/O, status and monitoring. For most applications, you can run the sample ladder program without modification, or, for advanced applications, you can incorporate the sample program into your existing application.

The inRAx Solutions CD provides one or more versions of the sample ladder logic. The version number appended to the file name corresponds with the firmware version number of your ControlLogix processor. The firmware version and sample program version must match.

To determine the firmware version of your processor

Important: The RSLinx service must be installed and running on your computer in order for RSLogix to communicate with the processor. Refer to your RSLinx and RSLogix documentation for help configuring and troubleshooting these applications.

- 1 Connect an RS-232 serial cable from the COM (serial) port on your PC to the communication port on the front of the processor.
- 2 Start RSLogix 5000 and close any existing project that may be loaded.
- 3 Open the Communications menu and choose **Go Online**. RSLogix will establish communication with the processor. This may take a few moments.

- 4 When RSLogix has established communication with the processor, the Connected To Go Online dialog box will open.

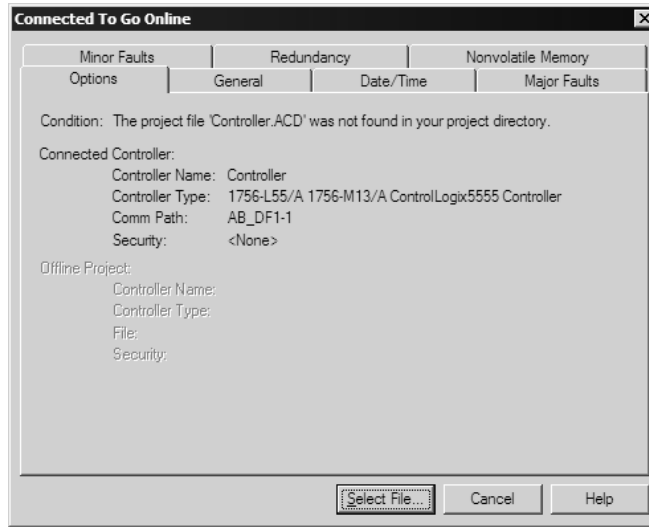

- 5 On the Connected To Go Online dialog box, click the General tab. This tab shows information about the processor, including the Revision (firmware) version. In the following illustration, the firmware version is 11.32

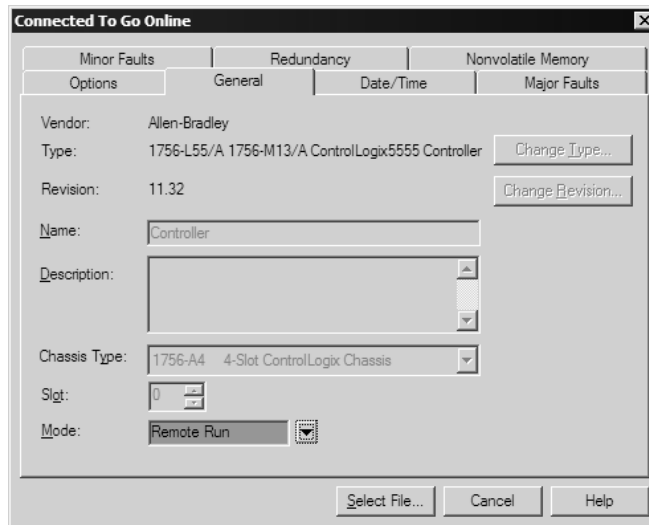

- 6 Select the sample ladder logic file for your firmware version.

To open the sample program

- 1 On the Connected to Go Online dialog box, click the Select File button.
- 2 Choose the sample program file that matches your firmware version, and then click the Select button.
- 3 RSLogix will load the sample program.

The next step is to configure the correct controller type and slot number for your application.

Choose the Controller Type

The sample application is for a 1756-L63 ControlLogix 5563 Controller. If you are using a different model of the ControlLogix processor, you must configure the sample program to use the correct processor model.

To change the Controller Type

- 1 In the Controller Organization list, select the folder "Controller MVI56_FLN", and then click the right mouse button to open a shortcut menu.
- 2 On the shortcut menu, choose **Properties**. This action opens the Controller Properties dialog box.

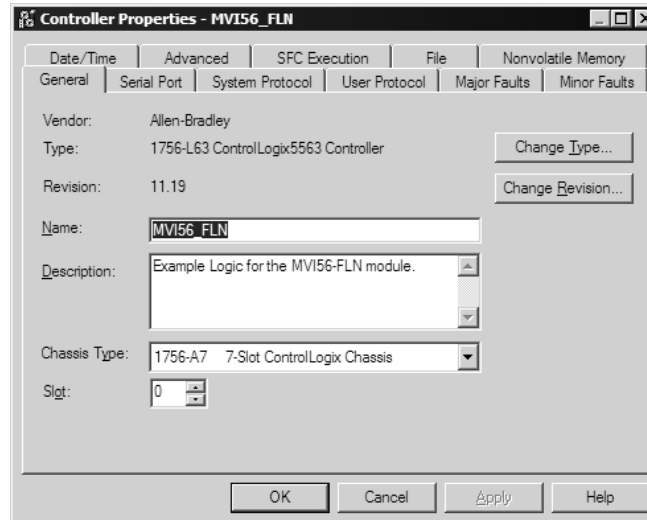

- 3 Click the **Change Controller** button. This action opens the Change Controller dialog box.

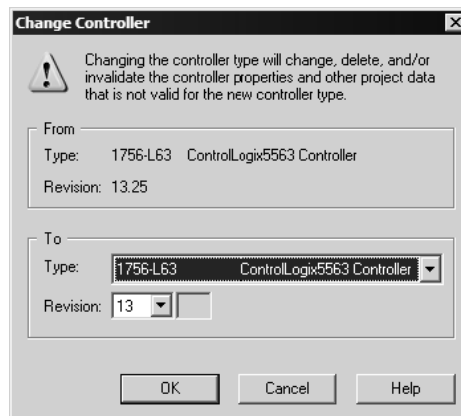

- 4 Open the Type: dropdown list, and then select your ControlLogix controller.

- 5 Select the correct firmware revision for your controller, if necessary.
- 6 Click OK to save your changes and return to the previous window.

Select the Slot Number for the Module

The sample application is for a module installed in Slot 1 in a ControlLogix rack. The ladder logic uses the slot number to identify the module. If you are installing the module in a different slot, you must update the ladder logic so that program tags and variables are correct, and do not conflict with other modules in the rack.

To change the slot number

- 1 In the Controller Organization list, select the module [1] 1756-MODULE MVI56, and then click the right mouse button to open a shortcut menu.
- 2 On the shortcut menu, choose **Properties**. This action opens the Module Properties dialog box.

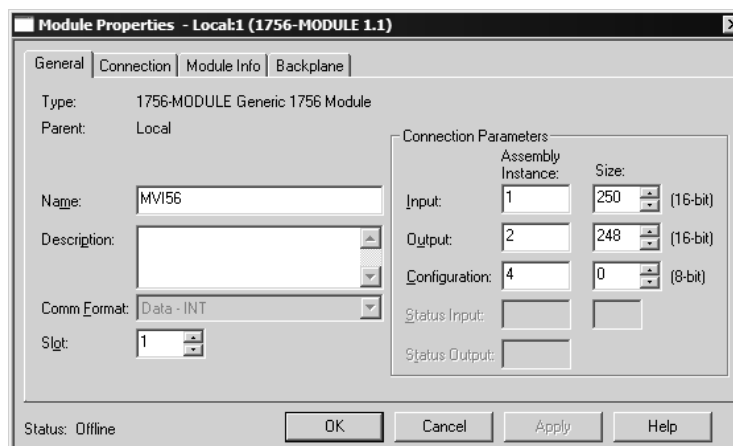

- 3 In the **Slot:** field, use the spinners on the right side of the field to select the slot number where the module will reside in the rack, and then click OK.

RSLogix will automatically apply the slot number change to all tags, variables and ladder logic rungs that use the MVI56-FLN slot number for computation.

1.6 Download the Sample Program to the Processor

To download the sample program from RSLogix 5000 to the ControlLogix processor:

Note: The key switch on the front of the ControlLogix module must be in the REM position.

- 1 If you are not already online to the processor, open the Communications menu, and then choose Download. RSLogix will establish communication with the processor.

- When communication is established, RSLogix will open a confirmation dialog box. Click the Download button to transfer the sample program to the processor.

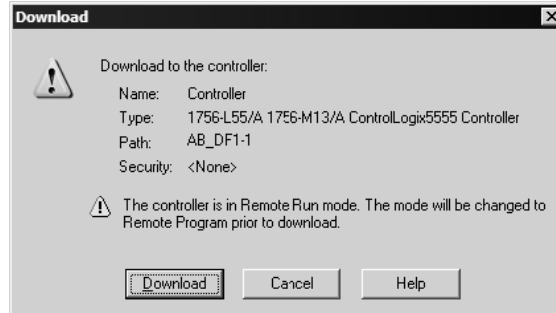

- RSLogix will compile the program and transfer it to the processor. This process may take a few minutes.
- When the download is complete, RSLogix will open another confirmation dialog box. Click OK to switch the processor from Program mode to Run mode.

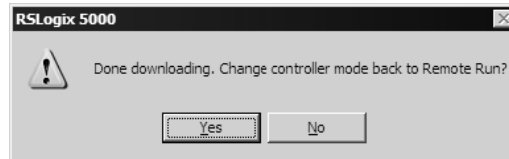

Note: If you receive an error message during these steps, refer to your RSLogix documentation to interpret and correct the error.

- To verify that the processor is communicating with the module, open the Main Program folder in the Controller Organization pane in RSLogix, and double-click MainRoutine. You will be able to see the numbers change in Rung 0 of the MainRoutine program.

The next step is to download the configuration files to the MVI56-FLN module.

1.6.1 Configuring RSLinx

If RSLogix is unable to establish communication with the processor, follow these steps:

- Open RSLinx.
- Open the Communications menu, and choose Configure Drivers.

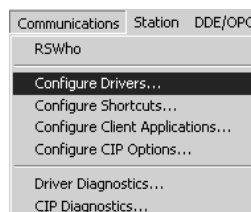

This action opens the Configure Drivers dialog box.

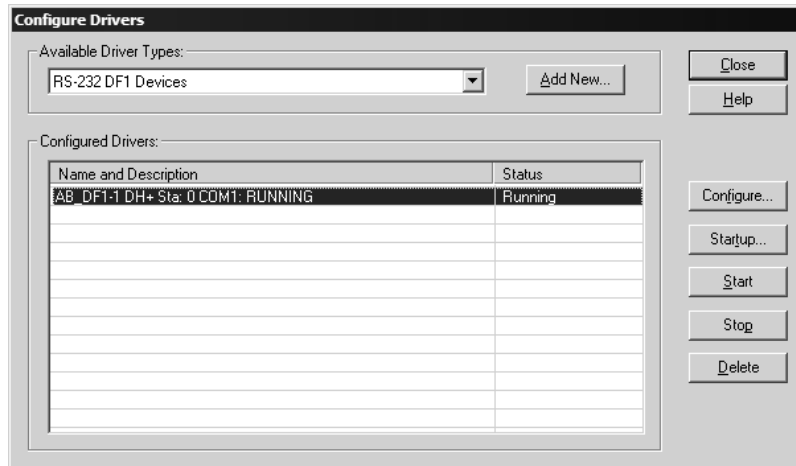

Note: If the list of configured drivers is blank, you must first choose and configure a driver from the Available Driver Types list. The recommended driver type to choose for serial communication with the processor is "RS-232 DF1 Devices".

- 3 Click to select the driver, and then click Configure. This action opens the Configure Allen-Bradley DF1 Communications Device dialog box.



- 4 Click the Auto-Configure button. RSLinx will attempt to configure your serial port to work with the selected driver.
- 5 When you see the message "Auto Configuration Successful", click the OK button to dismiss the dialog box.

Note: If the auto-configuration procedure fails, verify that the cables are connected correctly between the processor and the serial port on your computer, and then try again. If you are still unable to auto-configure the port, refer to your RSLinx documentation for further troubleshooting steps.

1.7 Connect your PC to the Module

With the module securely mounted, connect your PC to the **Configuration/Debug** port using an RJ45-DB-9 Serial Adapter Cable and a Null Modem Cable.

- 1 Attach both cables as shown.
- 2 Insert the RJ45 cable connector into the Configuration/Debug port of the module.
- 3 Attach the other end to the serial port on your PC or laptop.

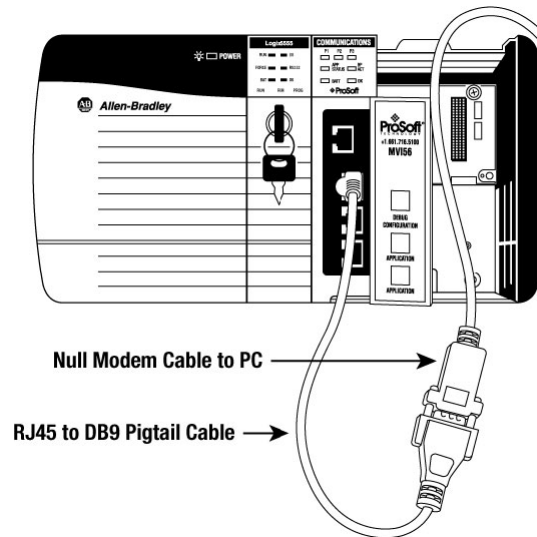

1.8 Configure the MVI56-FLN Module

The MVI56-FLN module requires the following configuration files:

- FLNET.CFG Module Configuration
- WATTCP.CFG Network Configuration

You can transfer these files from the MVI56-FLN module (S option from the Configuration/Debug Main Menu and Network Menu), or you can copy them from the ProSoft Solutions CD-ROM. You can edit both configuration files with a text editor such as Notepad.exe.

1.8.1 ProSoft Configuration Builder

ProSoft Configuration Builder (PCB) provides a quick and easy way to manage module configuration files customized to meet your application needs. PCB is not only a powerful solution for new configuration files, but also allows you to import information from previously installed (known working) configurations to new projects.

Set Up the Project

To begin, start ProSoft Configuration Builder. If you have used other Windows configuration tools before, you will find the screen layout familiar. ProSoft Configuration Builder's window consists of a tree view on the left, an information pane and a configuration pane on the right side of the window. When you first start ProSoft Configuration Builder, the tree view consists of folders for Default Project and Default Location, with a Default Module in the Default Location folder. The following illustration shows the ProSoft Configuration Builder window with a new project.

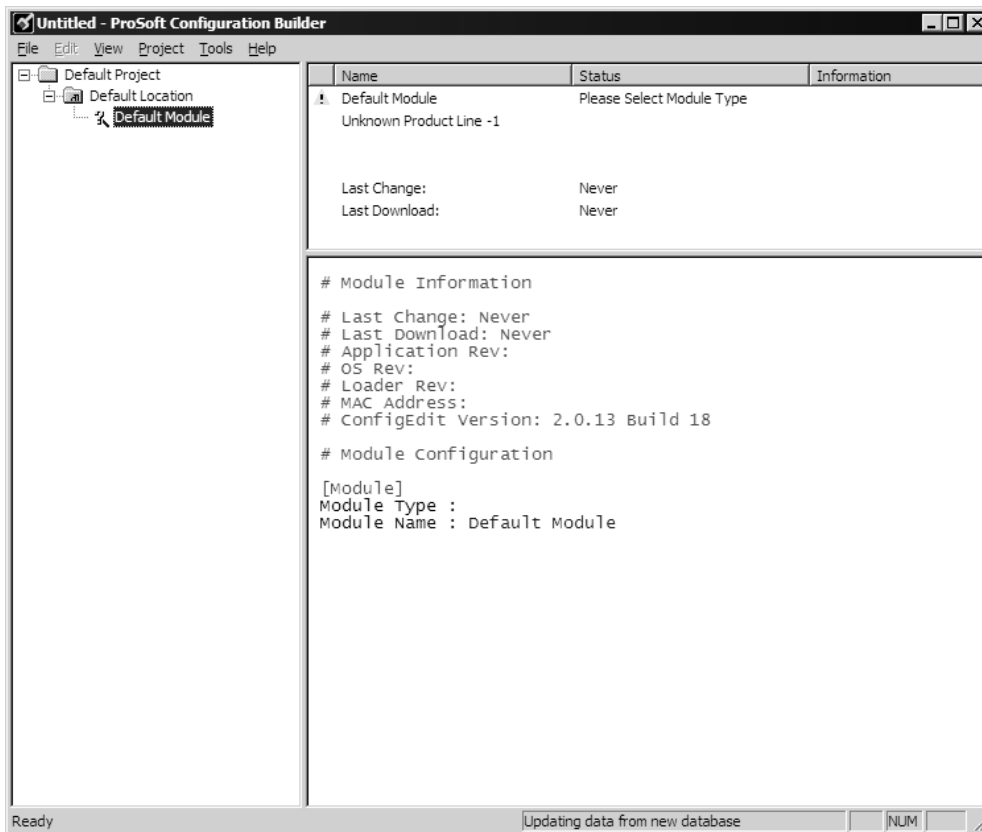

Your first task is to add the MVI56-FLN module to the project.

- 1 Use the mouse to select "Default Module" in the tree view, and then click the right mouse button to open a shortcut menu.

- On the shortcut menu, choose "Choose Module Type". This action opens the Choose Module Type dialog box.

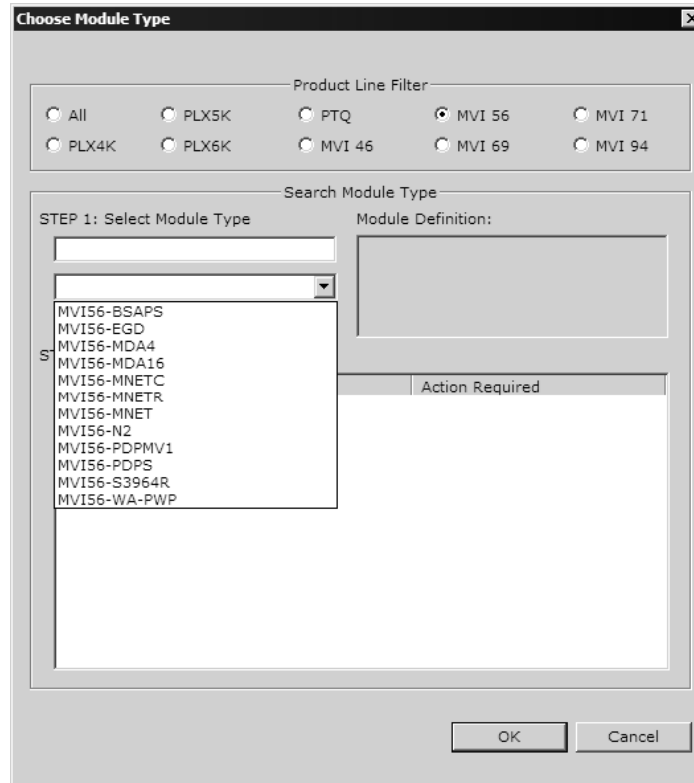

- In the Product Line Filter area of the dialog box, select MVI56. In the Select Module Type dropdown list, select MVI56-FLN, and then click OK to save your settings and return to the ProSoft Configuration Builder window.

The next task is to set the module parameters.

Adding a Project

To add a project to an existing project file:

- Select the Default Project icon.
- Choose Project from the Project menu, then choose Add Project. A new project folder appears.

Adding a Module

To add a module to your project:

- Double-click the Default Module icon to open the Choose Module Type dialog box.
- On the Choose Module Type dialog box, select the module type.

Or

- Open the Project menu and choose Location.
- On the Location menu, choose Add Module.

To add a module to a different location:

- 1 Right-click the Location folder and choose Add Module. A new module icon appears.

Or

- 1 Select the Location icon.
- 2 From the Project menu, select Location, then select Add Module.

Set Module Parameters

Notice that the contents of the information pane and the configuration pane changed when you added the MVI56-FLN module to the project.

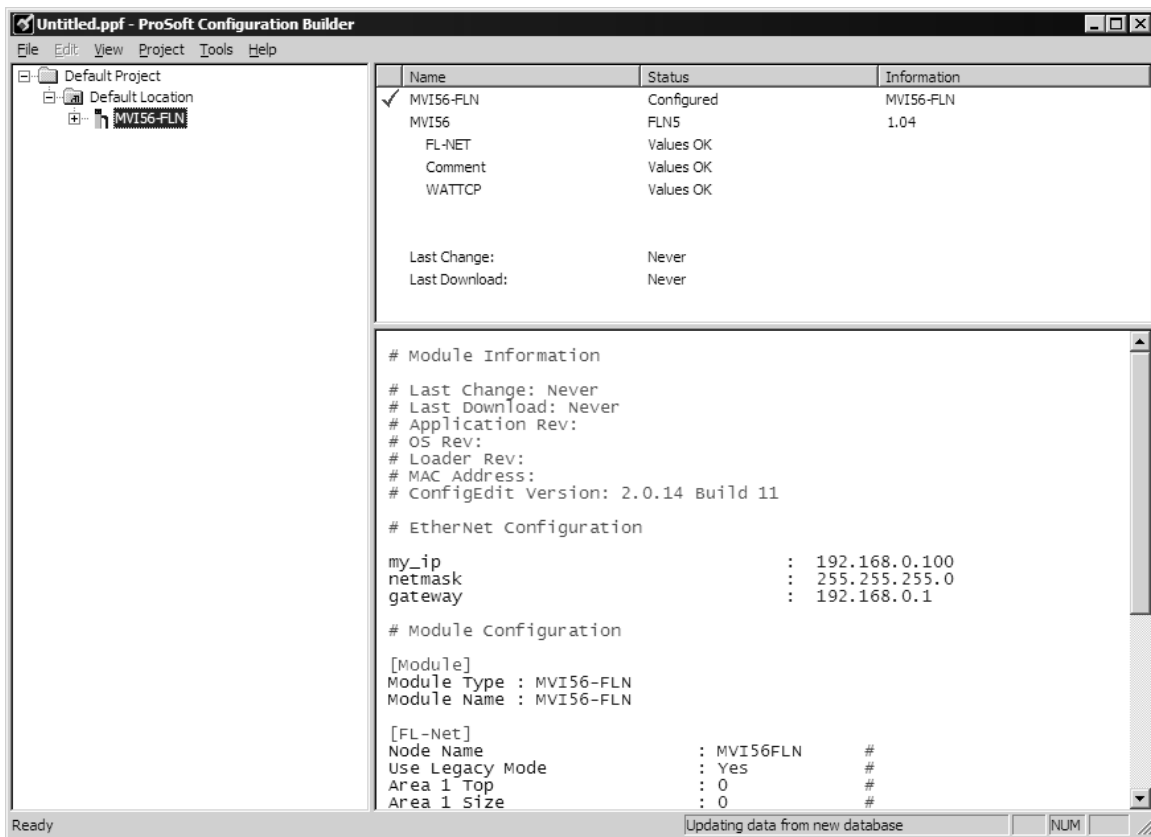



At this time, you may wish to rename the "Default Project" and "Default Location" folders in the tree view.

To rename an object:

- 1 Select the object, and then click the right mouse button to open a shortcut menu. From the shortcut menu, choose Rename.
- 2 Type the name to assign to the object.
- 3 Click away from the object to save the new name.



Module Entries

To configure module parameters

- 1 Click on the plus sign next to the icon  Comment to expand module information.
- 2 Double-click the  Module Comment icon to open the Edit dialog box.
- 3 To edit a parameter, select the parameter in the left pane and make your changes in the right pane.
- 4 Click OK to save your changes.

Comment Entries

To add comments to your configuration file:

- 1 Click the plus sign to the left of the  Comment icon to expand the Module Comments.
- 2 Double-click the  Module Comment icon. The Edit - Module Comment dialog appears.

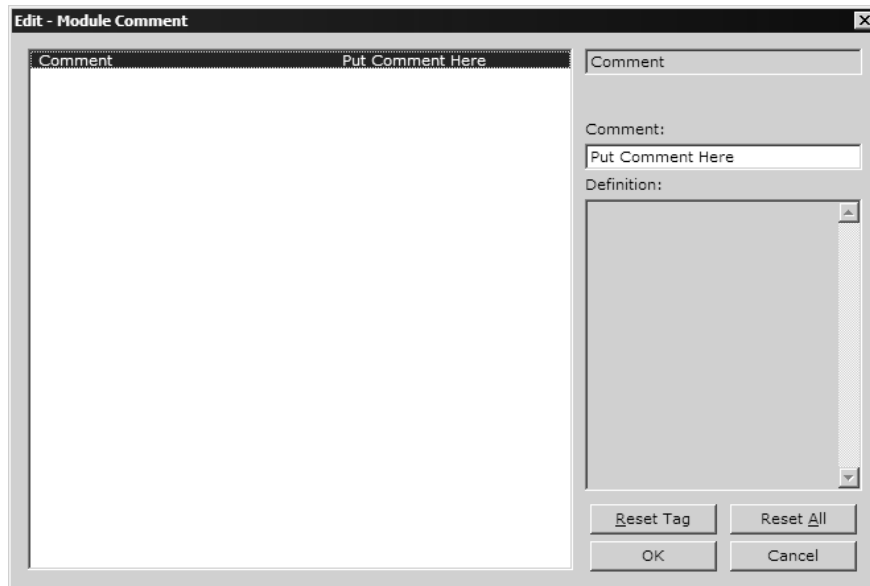

- 3 Enter your comment and click OK to save your changes.

Printing a Configuration File

To print a configuration file:

- 1 Select the Module icon, and then click the right mouse button to open a shortcut menu.
- 2 On the shortcut menu, choose View Configuration. This action opens the View Configuration window.
- 3 On the View Configuration window, open the File menu, and choose Print. This action opens the Print dialog box.
- 4 On the Print dialog box, choose the printer to use from the dropdown list, select printing options, and then click OK.

1.8.2 Configure Area 1 and Area 2

The next step is to configure the module to properly transfer data between the ControlLogix processor and the remote FLNET node (Toyoda PLC - TPLC). Each area is defined by its start address (top address) and word length (size). The following illustration shows the start addresses and word lengths used in the sample application:

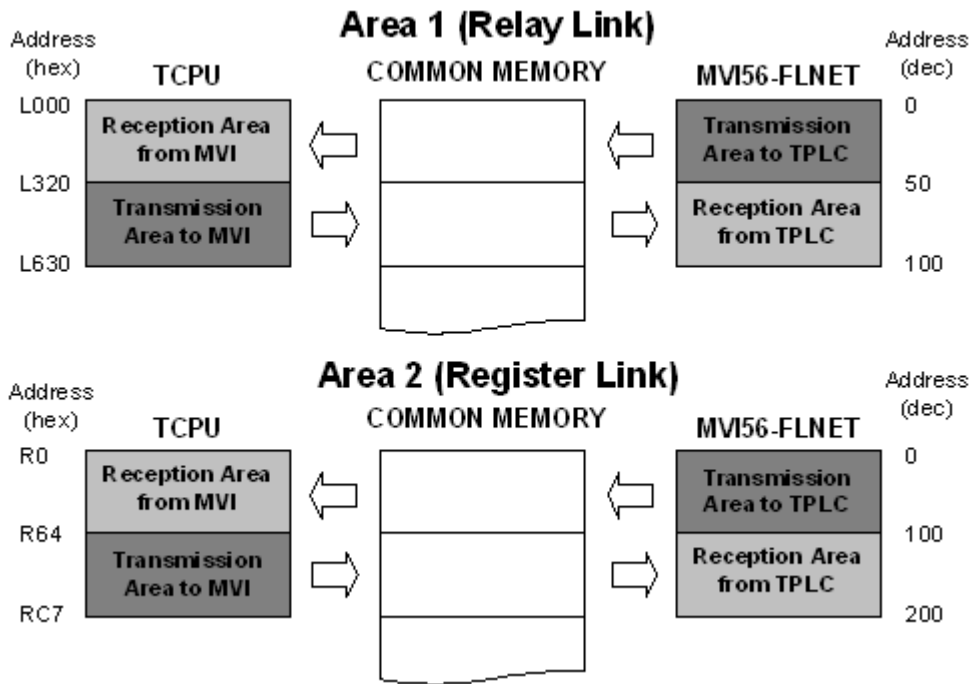

Refer to the MVI56-FLN configuration file (FLNET.CFG) to configure the module parameters for data transfer.

Use the following settings to configure the data to transfer from the module to the remote node. This data is transferred from the ControlLogix processor to the MVI56-FLN module through the *FLNETDATA.Output.Area1* and *FLNETDATA.Output.Area2* controller tag arrays.

```
Area 1 Top      : 0
Area 1 Size    : 50
Area 2 Top      : 0
Area 2 Size    : 100
```

Use the following settings to configure the data to transfer from the common memory to the processor. This data is transferred from the MVI56-FLN module to the ControlLogix processor through the *FLNETDATA.Input.Area1* and *FLNETDATA.Input.Area2* controller tag arrays.

```
BP Area 1 Top  : 50
BP Area 1 Size : 50
BP Area 2 Top  : 100
BP Area 2 Size : 100
```

The following illustration shows how the data is transferred:

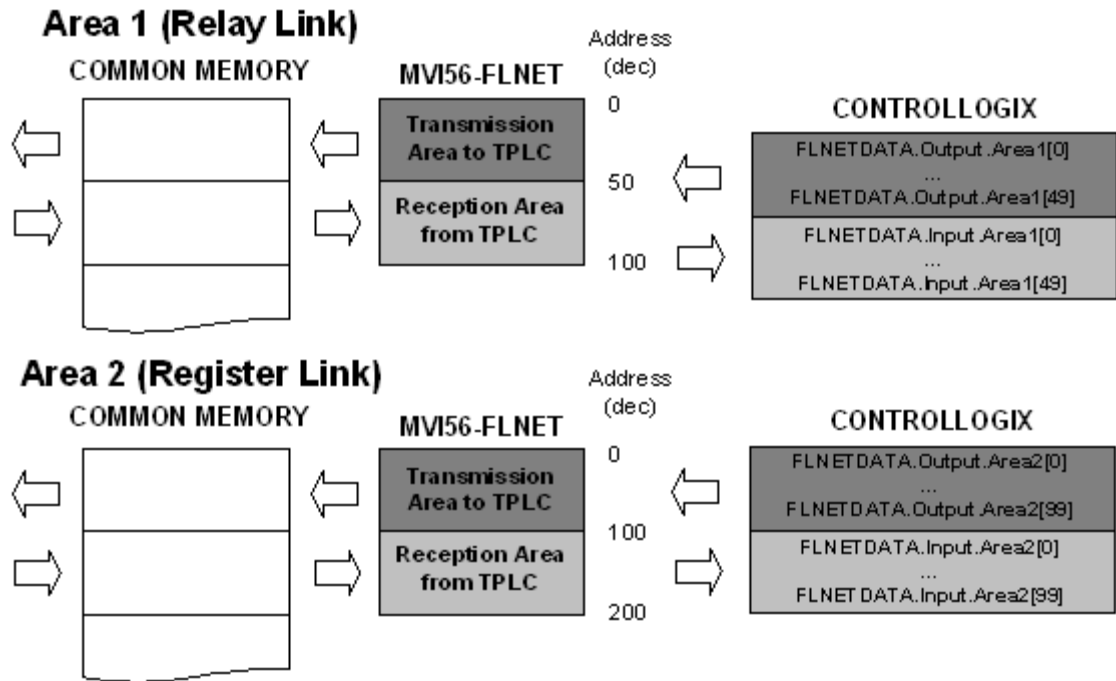

You can increase the area copied to the processor to also include the produced output data.

The following example shows how the data copied to the processor also includes the data produced by the module, which is available in the FLNET common memory.

This data is transferred from the MVI56-FLN module to the ControlLogix processor through the *FLNETDATA.Input.Area1* and *FLNETDATA.Input.Area2* controller tag arrays.

```
BP Area 1 Top : 0
BP Area 1 Size : 100
BP Area 2 Top : 0
BP Area 2 Size : 200
```

The data read from the remote FLNET starts at *FLNETDATA.Input.Area1[50]* (50 words) and *FLNETDATA.Input.Area2[100]* (50 words) controller tag arrays. The data produced by the module and available at the FLNET common memory starts at *FLNETDATA.Input.Area1[0]* (50 words) and *FLNETDATA.Input.Area2[0]* (50 words) controller tag arrays.

1.8.3 Configure the General Parameters

Configure the general parameters for your application. This example will consider the following parameters:

```
Node Name           : MVI56FLNET #identifies the node in the FLNET
network
Token Watchdog Time :          100 #token watchdog time (1..255) in ms
                        #(default=255)
Minimum Frame Interval Time:      20 #allowable min frame interval
                        #(20...50), #100 microsecond units
```

Note: Please refer to FL-net Node Configuration (page 96) for more information about these configuration parameters.

1.8.4 Data Mapping Functionality

Note: Data Mapping is supported for MVI56-FLN firmware version 1.04 and above only.

The data mapping feature allows the optimization of data transfer from the module to the ControlLogix processor.

Introduction

You can configure the sections of the A1 and A2 areas to be transferred to the processor through the following parameters:

```
BP Area 1 Top   :    0   #0...511 top address for area 1
BP Area 1 Size  :   200   #0...512 area 1 data size in words
BP Area 2 Top   :    0   #0...8191 top address for area 2
BP Area 2 Size  :  1440   #0...8192 area 2 data size in words
```

However, the data associated to the nodes is not necessarily in a contiguous order. Also, the application may require only specific data from each node that could be spread over the configured area to be transferred to the processor. This implementation may lead to the transfer of unused data to the processor, causing unnecessary delays to the overall module performance.

Example 1

In this example, the module receives data from four different nodes associated to the Area 2 common memory. Therefore, the module should be configured to transfer the first 1200 words of data to the processor as follows:

```
BP Area 2 Top   :    0   #0...8191 top address for area 2
BP Area 2 Size  :  1440   #0...8192 area 2 data size in words
```

The module can only transfer a block of 240 words at a time. Therefore, for the following application, the module would have to transfer unused data in order to transfer the entire data associated to the four slaves to the processor. The result is that unused blocks would have to be transferred, resulting in unnecessary delay to the overall performance.

Without Map Feature

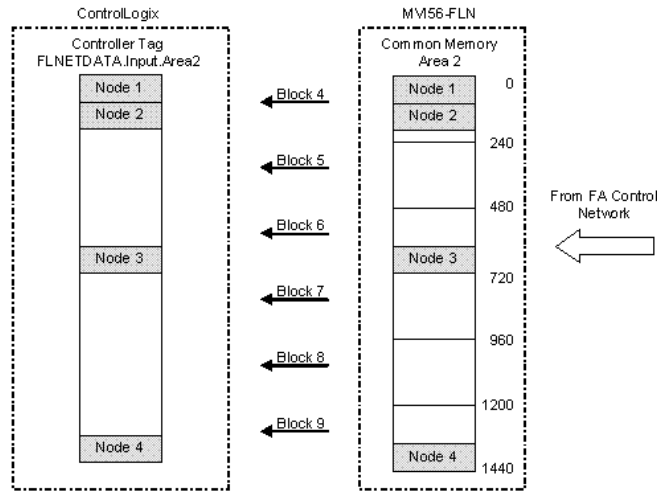

The data mapping feature allows you to select data sections associated to each slave, and select these to be mapped (in any order) into a virtual backplane map area. This virtual area will be copied to the processor (instead of the entire common memory area).

This feature allows the module to copy only specific data required for the application, as shown in the following illustration. Unused data blocks are not required to be copied:

With Map Feature

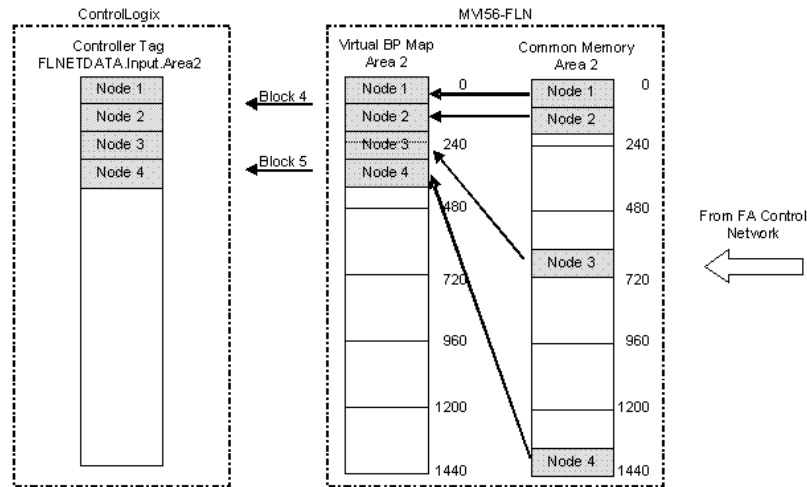

Instead of copying six blocks, the module only copies two blocks to send the data associated to all four nodes. You would also re-configure the portion of the Virtual BP Map area to be copied to the processor as follows:

```
BP Area 2 Top : 0 #0...8191 top address for area 2
BP Area 2 Size : 480 #0...8192 area 2 data size in words
```

Setting the Mapping Parameters

To set mapping parameters

- 1 Enable the Use BP Map Table parameter with a value of Y as follows:

Use BP Map Table : Y #Use BP mapping (Y=Use maps, N=Don't use maps (default))

- 2 Setup the mapping for your application through the [FL-NET BACKPLANE MAPPING] section of the configuration file.

```
[FL-NET BACKPLANE MAPPING]
#Node      A1 Network  A1 Network  A1 Backplane  A2 Network  A2 Network  A2 Backplane
#           Start      Size        Start         Start        Size         Start
START
  1         0          150         0             0            150          0
  2        100         50         150           100           50          150
END
```

Where each parameter is defined as follows:

Parameter	Description
Node	Node number
A1 Network Start	Start word offset in the node area (within the network common memory) to be mapped into the virtual backplane map. This is not the absolute offset within the common memory. For example, if the node top address is 200 (size of 150 words), in order to remap the last 50 words of that node then enter a A1 Network Start value of 100 (not 300).
A1 Network Size	Total number of words (starting from A1 Network Start offset) to be mapped into the virtual backplane map.
A1 Network Backplane Start	Start absolute word offset in the virtual backplane map where the mapped A1 data will be copied to.
A2 Network Start	Start word offset in the node area (within the network common memory) to be mapped into the virtual backplane map. This is not the absolute offset within the common memory. For example, if the node top address is 200 (size of 150 words), in order to remap the last 50 words of that node then enter a A2 Network Start value of 100 (not 300).
A2 Network Size	Total number of words (starting from A2 Network Start offset) to be mapped into the virtual backplane map.
A2 Network Backplane Start	Start absolute word offset in the virtual backplane map where the mapped A2 data will be copied to.

- 3 Setup the portion of the virtual backplane map to be transferred to the processor.

```
BP Area 1 Top : 0 #0...511 top address for area 1
BP Area 1 Size : 200 #0...512 area 1 data size in words
BP Area 2 Top : 0 #0...8191 top address for area 2
BP Area 2 Size : 200 #0...8192 area 2 data size in words
```

The following example shows how to use the map feature by configuring the module parameters.

Example 2

This example application requires the MVI56-FLN module to communicate with two nodes configured as follows:

Node 1

```
Area 1 Top : 0
Area 1 Size: 150
Area 2 Top : 0
Area 2 Size: 150
```

Node 2

```
Area 1 Top : 240
Area 1 Size: 150
Area 2 Top : 240
Area 2 Size: 150
```

The MVI56-FLN must transfer the following data to the processor:

- Entire node 1 data
- Last 50 words of node 2 data

Without Data Mapping

In order to disable the data mapping, set the Use BP Map Table parameter as N:

```
Use BP Map Table : N #Use BP mapping (Y=Use maps, N=Don't use maps
(default))
```

Because the goal is to transfer the entire Node 1 data and the last 50 words for Node 2 data, the backplane transfer to the processor should be set as follows:

```
BP Area 1 Top : 0 #0...511 top address for area 1
BP Area 1 Size : 390 #0...512 area 1 data size in words
BP Area 2 Top : 0 #0...8191 top address for area 2
BP Area 2 Size : 390 #0...8192 area 2 data size in words
```

Therefore, two blocks per each area will be required to transfer the data as follows:

Read Block ID	Area	Start Area Offset	Last Area Offset
1	1	0	239
2	1	240	389
4	2	0	239
5	2	240	389

The following illustration demonstrates this application:

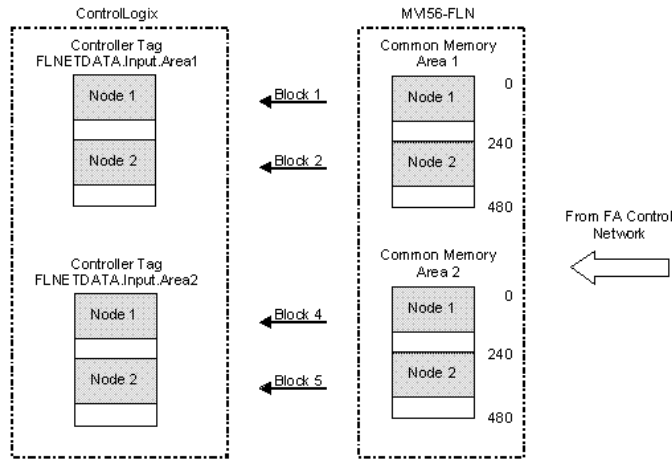

Note: This application only requires the last 50 words from Node 2, but it must transfer the entire data because the transferred data must be organized.

With Data Mapping

In order to enable the mapping feature set the Use BP Map Table parameter as Y:

Use BP Map Table : Y #Use BP mapping (Y=Use maps, N=Don't use maps (default))

Now configure the mapping settings through the [FL-NET BACKPLANE MAPPING] section in the configuration file. The goal is to remap only the areas to be transferred to the application in a contiguous order to provide optimal performance.

For this example the application requires only the following areas to be transferred to the processor (same offsets for both Area 1 and Area 2):

- Node 1 = Common Memory Data Offset from 0 to 149
- Node 2 = Common Memory Data Offset from 340 to 389

The following illustration shows how to configure this section for this example:

# Node #	A1 Network Start	A1 Network Size	A1 Backplane Start	A2 Network Start	A2 Network Size	A2 Backplane Start
START						
1	0	150	0	0	150	0
2	100	50	150	100	50	150
END						

The following illustration shows how the data transfer would occur for this example:

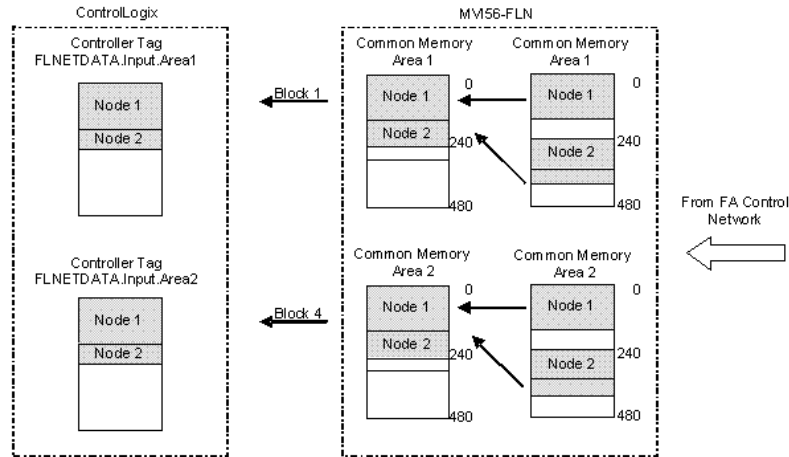

Important: A1 Network Start and A2 Network Start parameters refer to the start offset within each node's area. So for this example node 2 mapping was configured as:
A1 Network Start = A2 Network Start = 100
Therefore, the A1/A2 Network Start offsets do not indicate the absolute Common Memory offset (340 for this example). It indicates the starting offset within that specific node's area (100 for this example).

1.8.5 Configure the Node Number

Configure the MVI56-FLN module with a node number of 40. The last digit of the IP address is used to denote the node number of the module.

Refer to the configuration file WATTCP.CFG and configure both parameters as follows:

```
my_ip=192.168.250.40
netmask=255.255.255.0
```

1.8.6 Ethernet Configuration

Use this procedure to configure the Ethernet settings for your module. You must assign an IP address, subnet mask and gateway address. After you complete this step, you can connect to the module with an Ethernet cable.

- 1 Determine the network settings for your module, with the help of your network administrator if necessary. You will need the following information:
 - o IP address (fixed IP required) _____ . _____ . _____ . _____
 - o Subnet mask _____ . _____ . _____ . _____
- 2 Gateway address _____ . _____ . _____ . _____ Click [+] to expand the tree for the MVI56-FLN module.

- 3 Double-click the Ethernet Configuration object. This action opens the Edit dialog box.

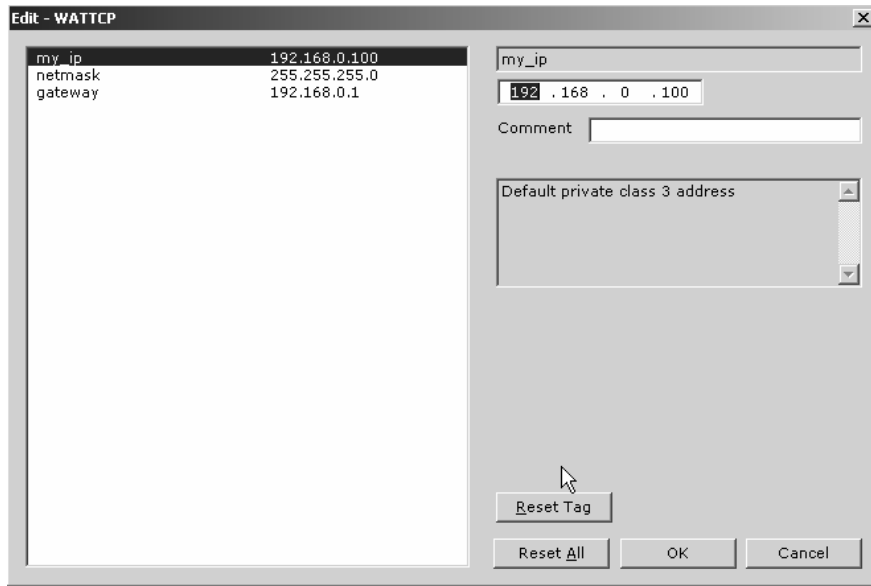

- 4 Edit the values for my_ip, netmask (subnet mask) and gateway (default gateway).
- 5 When you are finished editing, click OK to save your changes and return to the ProSoft Configuration Builder window.

1.9 Download the Project to the Module

In order for the module to use the settings you configured, you must download (copy) the updated Project file from your PC to the module.

To Download the Project File

- 1 In the tree view in ProSoft Configuration Builder, click once to select the MVI56-FLN module.
- 2 Open the **Project** menu, and then choose **Module / Download**. The program will scan your PC for a valid com port (this may take a few seconds). When PCB has found a valid com port, the following dialog box will open.

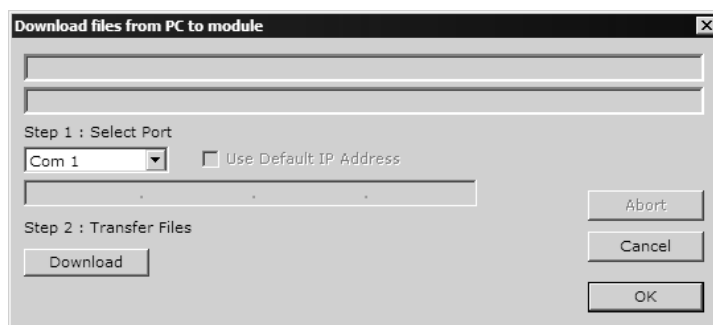

- 3 Choose the com port to use from the dropdown list, and then click the Download button.

The module will perform a platform check to read and load its new settings. When the platform check is complete, the status bar in ProSoft Configuration Builder will be updated with the message *"Module Running"*.

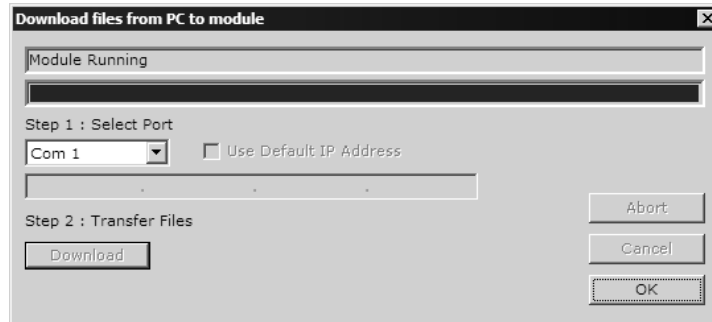

1.10 Cable Connections

The MVI56-FLN module has the following communication connections on the module:

- One Ethernet port (RJ45 connector)
- One RS-232 Configuration/Debug port (RJ45 connector)

1.10.1 Ethernet Connection

The MVI56-FLN module has an RJ45 port located on the front of the module labeled "Ethernet", for use with the TCP/IP network. The module is connected to the Ethernet network using an Ethernet cable between the module's Ethernet port and an Ethernet switch or hub.

Note: Depending on hardware configuration, you may see more than one RJ45 port on the module. The Ethernet port is labeled "Ethernet".

Warning: The MVI56-FLN module is NOT compatible with Power Over Ethernet (IEEE802.3af / IEEE802.3at) networks. Do NOT connect the module to Ethernet devices, hubs, switches or networks that supply AC or DC power over the Ethernet cable. Failure to observe this precaution may result in damage to hardware, or injury to personnel.

Important: The module requires a static (fixed) IP address that is not shared with any other device on the Ethernet network. Obtain a list of suitable IP addresses from your network administrator BEFORE configuring the Ethernet port on this module. The last digit of the IP address is used to denote the node number of the module.

Ethernet Port Configuration - wattcp.cfg

The wattcp.cfg file must be set up properly in order to use a TCP/IP network connection. You can view the current network configuration using an ASCII terminal by selecting "@" (Network Menu) and "V" (View) options when connected to the Debug port.

```
# WATTCP.CFG FILE:  
# ProSoft Technology.  
my_ip=192.168.0.40  
# Default class 3 network mask  
netmask=255.255.255.0  
# The gateway I wish to use  
gateway=192.168.0.1
```

1.10.2 RS-232 Configuration/Debug Port

This port is physically an RJ45 connection. An RJ45 to DB-9 adapter cable is included with the module. This port permits a PC based terminal emulation program to view configuration and status data in the module and to control the module. The cable for communications on this port is shown in the following diagram:

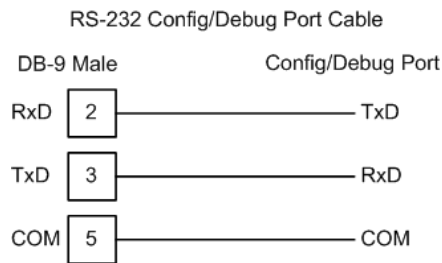

Disabling the RSLinx Driver for the Com Port on the PC

The communication port driver in RSLinx can occasionally prevent other applications from using the PC's COM port. If you are not able to connect to the module's configuration/debug port using ProSoft Configuration Builder (PCB), HyperTerminal or another terminal emulator, follow these steps to disable the RSLinx Driver.

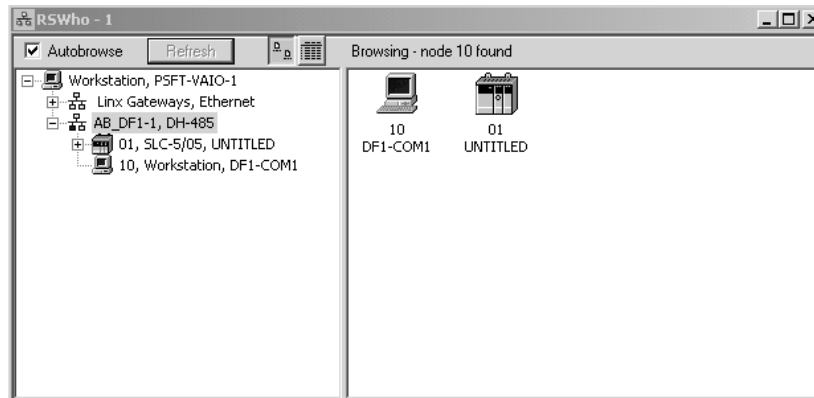

- 1 Open RSLinx and go to Communications>RSWho

- 2 Make sure that you are not actively browsing using the driver that you wish to stop. The following shows an actively browsed network:

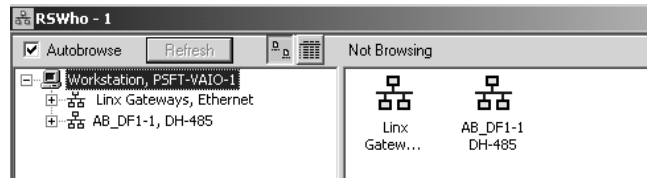

- 3 Notice how the DF1 driver is opened, and the driver is looking for a processor on node 1. If the network is being browsed, then you will not be able to stop this driver. To stop the driver your RSWWho screen should look like this:



Branches are displayed or hidden by clicking on the  or the  icons.

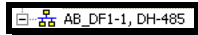

- 4 When you have verified that the driver is not being browsed, go to **Communications>Configure Drivers**
You may see something like this:

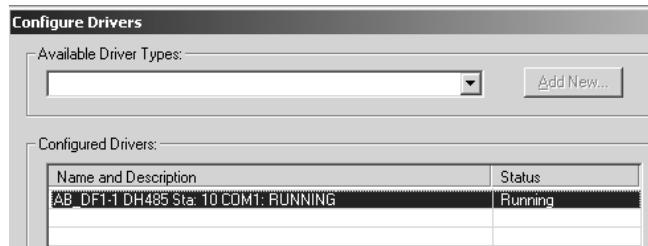

If you see the status as running, you will not be able to use this com port for anything other than communication to the processor. To stop the driver press the "Stop" on the side of the window:



5 After you have stopped the driver you will see the following:

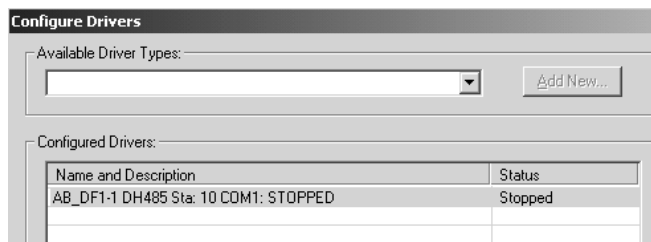

6 Upon seeing this, you may now use that com port to connect to the debug port of the module.

Note: You may need to shut down and restart your PC before it will allow you to stop the driver (usually only on Windows NT machines). If you have followed all of the above steps, and it will not stop the driver, then make sure you do not have RSLogix open. If RSLogix is not open, and you still cannot stop the driver, then reboot your PC.

1.10.3 DB9 to RJ45 Adaptor (Cable 14)

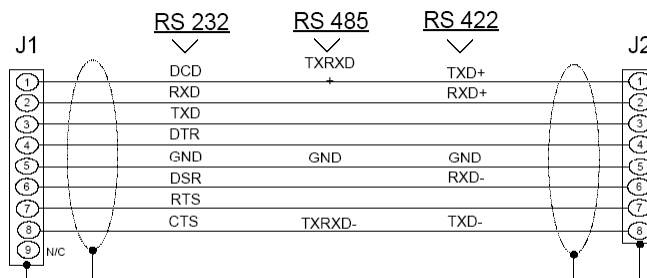
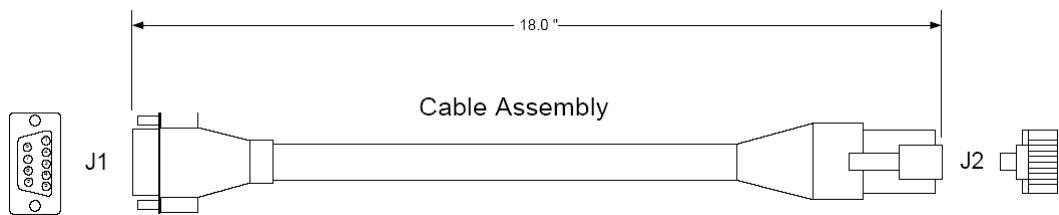

Wiring Diagram



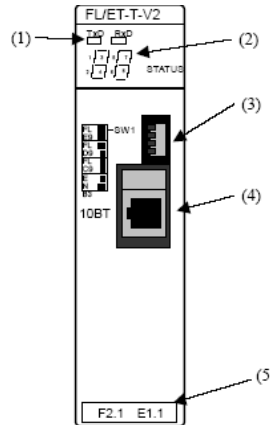

1.11 Setup the FL/ET-T-V2 Module

1.11.1 Set Operation Mode Switch

Select the correct operation mode through the switch (item 3 below)



The following options are available. This procedure will consider the first option (ID Code = C9 - 8kbytes of Link Memory Capacity)

Switch Positions	I/O module ID Code	Link Memory Capacity	Data Link Capacity (maximum number of total words in reception and transmission areas)
 1 & 2 off	C9	8 kbytes	Relay link: 2048 points (128 words) (*2) Register link: 2048 words (*1)
 1 off, 2 on	D9	16 kbytes	Relay link: 2048 points (128 words) (*2) Register link: 6144 words (* 1)
 1 & 2 on	E9	32 kbytes	Relay link: 2048 points (128 words) (*2) Register link: 8192 words (*1)
 1 on, 2 off	B3	4 kbytes	The module is operated as Ethernet.

1.12 FL/ET-V2 Configuration with PCwin

1.12.1 Specify I/O Module ID Code

Expand the *Parameter* folder, and double-click *I/O Module*

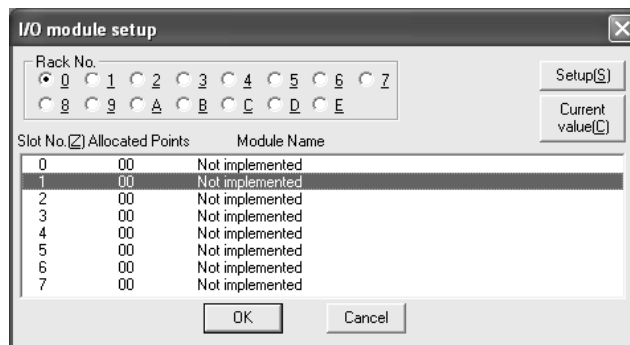
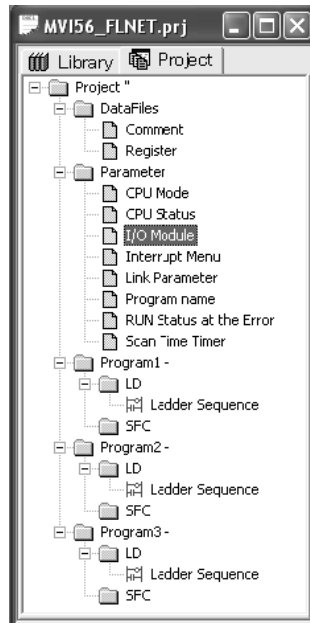

Select the FL-net module

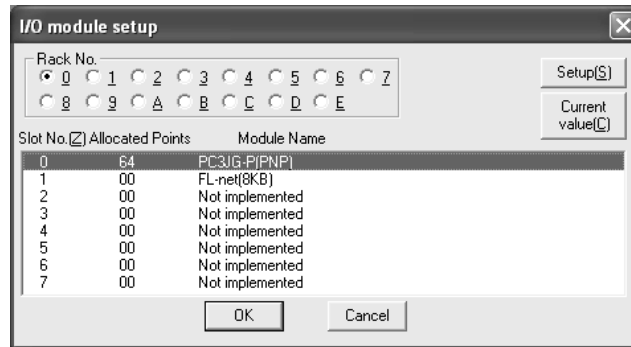
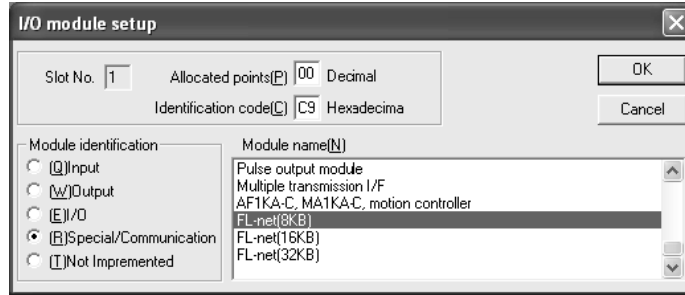

1.12.2 Setup the FL/ET-V2 Link Parameters

Double-click Link Parameter

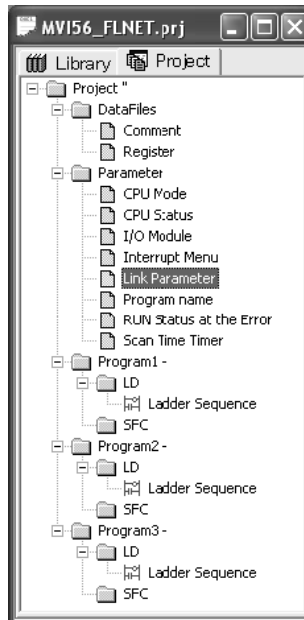

Select the link number to assign to the FL/ET-T-V2 module. For this example, use Link No 1 for the FL/ET-T-V2 module. Double click the link row and configure the correct slot, rack and module for link 1 as shown in the following illustrations:

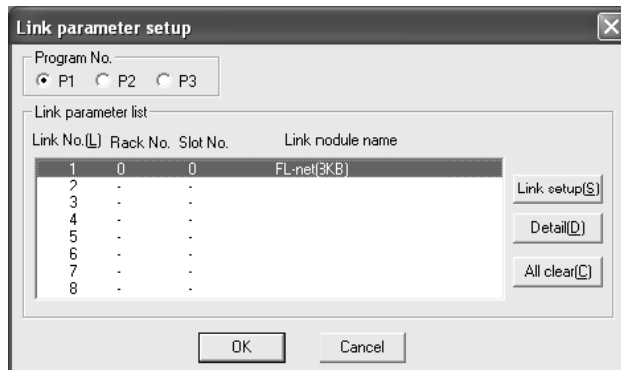
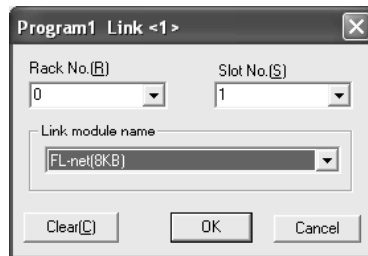
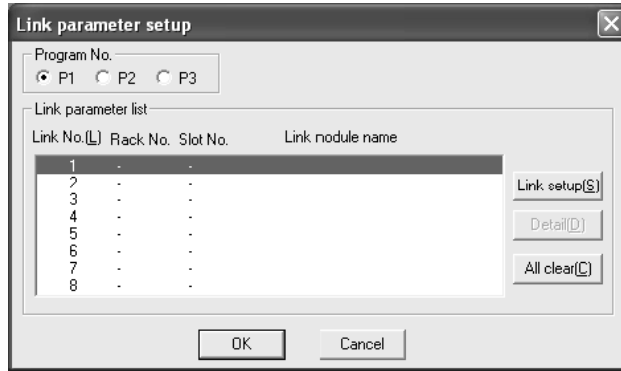

Now click the Detail button to configure the following link parameters:

- Node Number = 10
- Communication Method = N:N or 1:N (Master)

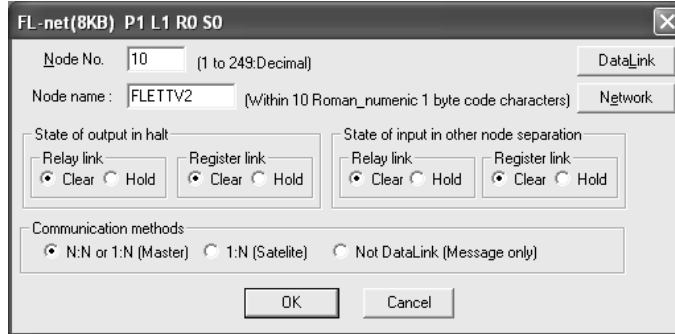

Click the Data Link button to configure the common memory that will be shared by all participating nodes in communication.

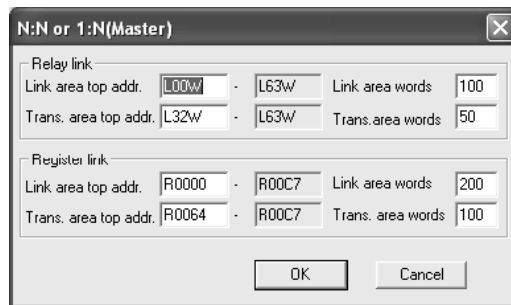

For this example, the data transfer takes place as described in the following illustration (the Transmit Area in the TOYODA PLC must be configured inside the Link Area):

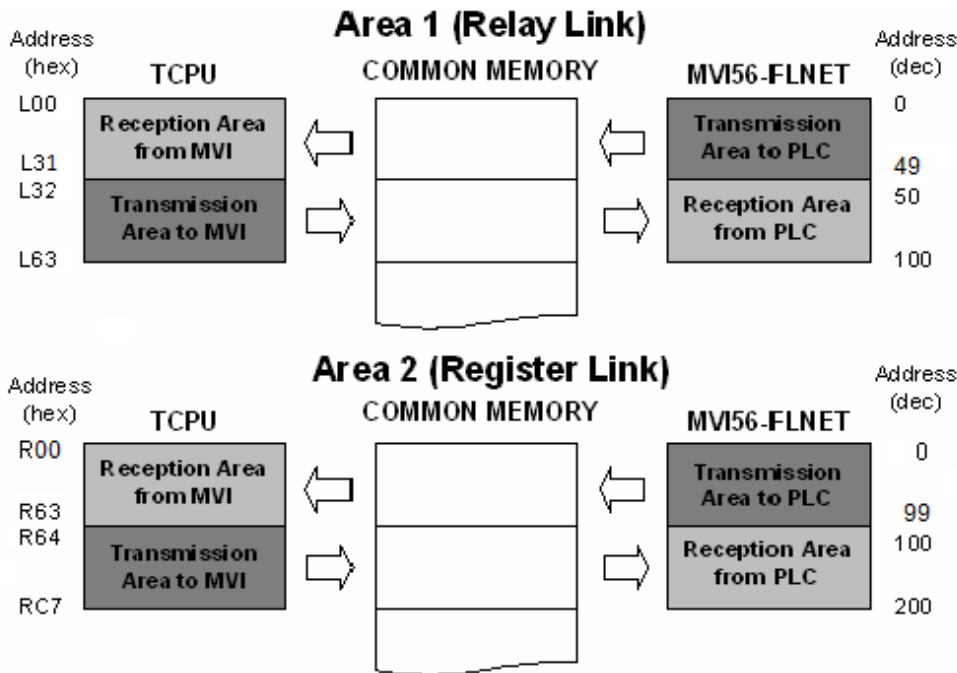

Click OK to close the Data Link window, and then click the Network button. Configure the default parameters as shown in the following illustration:

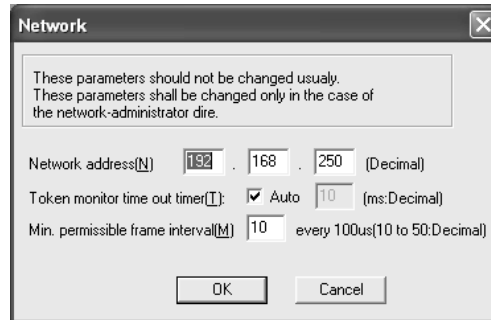

Note: This configuration sets the node address of the FL/ET-T-V2 module to 192.168.250.10 (the node address was configured as 10).

For this example, the processor (rack 0 and slot 0) will be assigned as DLNK-M2. For more information about this topic, refer to the TOYODA PLC documentation.

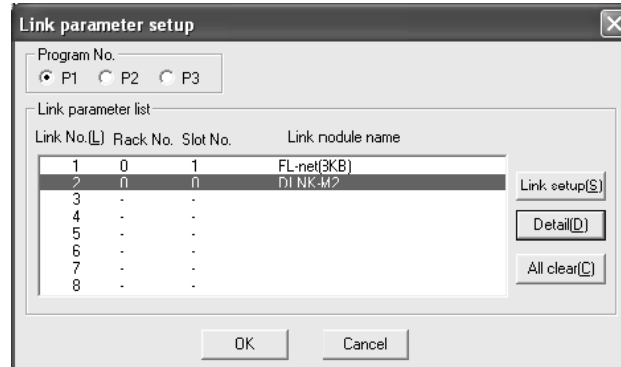

1.13 Download the Project

Now save the project and download it to the TOYODA PLC.

1.14 Connect the MVI56-FLN Module to the FL/ET-T-V2

Use standard CA5 Ethernet cables to connect the Ethernet port on the MVI56-FLN through a 10 Megabit Ethernet hub or switch to the Ethernet port on the FL/ET-T-V2 module.

Warning: The MVI56-FLN module is NOT compatible with Power Over Ethernet (IEEE802.3af / IEEE802.3at) networks. Do NOT connect the module to Ethernet devices, hubs, switches or networks that supply AC or DC power over the Ethernet cable. Failure to observe this precaution may result in damage to hardware, or injury to personnel.

1.15 Verifying Communication

This section shows how to monitor the communication status of the configured FL-net network (assuming that both the FL/ET-T-V2 module and the MVI56-FLN module were configured according to the previous sections).

1.15.1 Using the Configuration/Debug Port

To connect to the module's Configuration/Debug port:

- 1 Connect your computer to the module's port using a null modem cable.
- 2 Start the communication program on your computer and configure the communication parameters with the following settings:

Baud Rate	57,600
Parity	None
Data Bits	8
Stop Bits	1
Software Handshaking	None

- 3 Open the connection. When you are connected, press the [?] key on your keyboard. If the system is set up properly, you will see a menu with the module name followed by a list of letters and the commands associated with them.

If there is no response from the module, follow these steps:

- 1 Verify that the null modem cable is connected properly between your computer's serial port and the module. A regular serial cable will not work.
- 2 Verify that RSLinx is not controlling the COM port. Refer to Disabling the RSLinx Driver for the Com Port on the PC (page 38).
- 3 Verify that your communication software is using the correct settings for baud rate, parity and handshaking.
- 4 On computers with more than one serial port, verify that your communication program is connected to the same port that is connected to the module.

If you are still not able to establish a connection, you can contact ProSoft Technology Technical Support for further assistance.

1.15.2 The Configuration/Debug Menu

The Configuration and Debug menu for this module is arranged as a tree structure, with the Main Menu at the top of the tree, and one or more sub-menus for each menu command. The first menu you see when you connect to the module is the Main menu.

Because this is a text-based menu system, you enter commands by typing the command letter from your computer keyboard in the terminal application (for example, HyperTerminal). The module does not respond to mouse movements or clicks. The command executes as soon as you press the command letter — you do not need to press **[Enter]**. When you type a command letter, a new screen will be displayed in your terminal application.

Important: You must download the sample ladder to the ControlLogix processor, otherwise the module will be unable to establish communication with the processor.

If you see the message

"Waiting for connection to processor..."

when you connect to the configuration/debug port on the MVI56-FLN module using HyperTerminal, connect to the processor with RSLogix and download the sample ladder logic to the processor before continuing.

Navigation

All of the sub-menus for this module contain commands to redisplay the menu or return to the previous menu. You can always return from a sub-menu to the next higher menu by pressing **[M]** on your keyboard.

The organization of the menu structure is represented in simplified form in the following illustration:

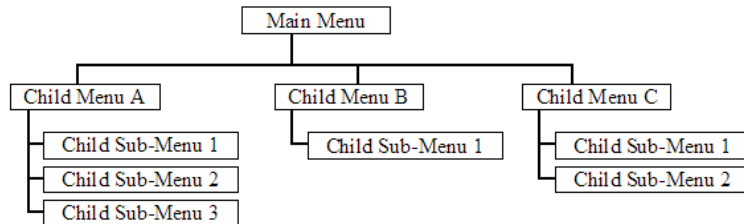

The remainder of this section shows you the menus available for this module, and briefly discusses the commands available to you.

Keystrokes

The keyboard commands on these menus are almost always non-case sensitive. You can enter most commands in lower case or capital letters.

The menus use a few special characters (**[?]**, **[-]**, **[+]**, **[@]**) that must be entered exactly as shown. Some of these characters will require you to use the **[Shift]**, **[Ctrl]** or **[Alt]** keys to enter them correctly. For example, on US English keyboards, enter the **[?]** command as **[Shift][/]**.

Also, take care to distinguish capital letter **[I]** from lower case letter **[i]** (L) and number **[1]**; likewise for capital letter **[O]** and number **[0]**. Although these characters look nearly the same on the screen, they perform different actions on the module.

1.15.3 Using the Module Debug Menu

Checking the Nodes Exchanging Data

From the Main Menu select:

FL-net Menu (F) → Node Data Exchange (D)

This menu contains a table that indicates all nodes that are exchanging data with the MVI56-FLN module. In the following table, each group of four digits corresponds to a word (16-bits) displayed in hexadecimal format. This table describes a sequence of bits that correspond to each FL-net node.

The following tables show the correlation between the bits and the nodes on the FL-net network for the first three words:

Word	0															
Bit #	0	1	2	3	4	5	6	7	8	9	10	11	12	13	14	15
Node #	0	1	2	3	4	5	6	7	8	9	10	11	12	13	14	15

Word	1															
Bit #	0	1	2	3	4	5	6	7	8	9	10	11	12	13	14	15
Node #	16	17	18	19	20	21	22	23	24	25	26	27	28	29	30	31

Word	2															
Bit #	0	1	2	3	4	5	6	7	8	9	10	11	12	13	14	15
Node #	32	33	34	35	36	37	38	39	40	41	42	43	44	45	46	47

The following illustration shows that that node 10 is in data exchange mode: the value 0400 hex indicates that bit 10 is set with a value of 1, and all other bits have a value of 0.

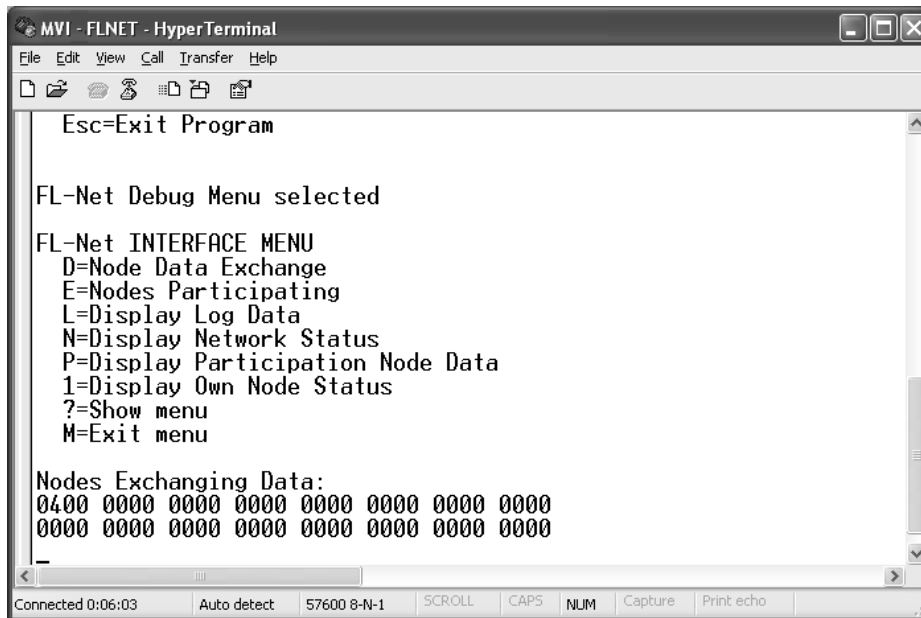

Checking the Participating Nodes

From the Main Menu select:

FL-net Menu (F) → Nodes Participating (E)

In the following tables, each group of four digits corresponds to a word (16-bits) displayed in hexadecimal format. This table describes a sequence of bits that correspond to each FL-net node.

The following tables show the correlation between the bits and the nodes on the FL-net network for the first three words:

Word	0															
Bit #	0	1	2	3	4	5	6	7	8	9	10	11	12	13	14	15
Node #	0	1	2	3	4	5	6	7	8	9	10	11	12	13	14	15

Word	1															
Bit #	0	1	2	3	4	5	6	7	8	9	10	11	12	13	14	15
Node #	16	17	18	19	20	21	22	23	24	25	26	27	28	29	30	31

Word	2															
Bit #	0	1	2	3	4	5	6	7	8	9	10	11	12	13	14	15
Node #	32	33	34	35	36	37	38	39	40	41	42	43	44	45	46	47

The following illustration shows that nodes 10 and 40 are participating: a value of 0400 hex in word 0 indicates that bit 10 is set with a value of 1 and a value of 0100 hex in word 2 indicates that bit 40 is set with a value of 1.

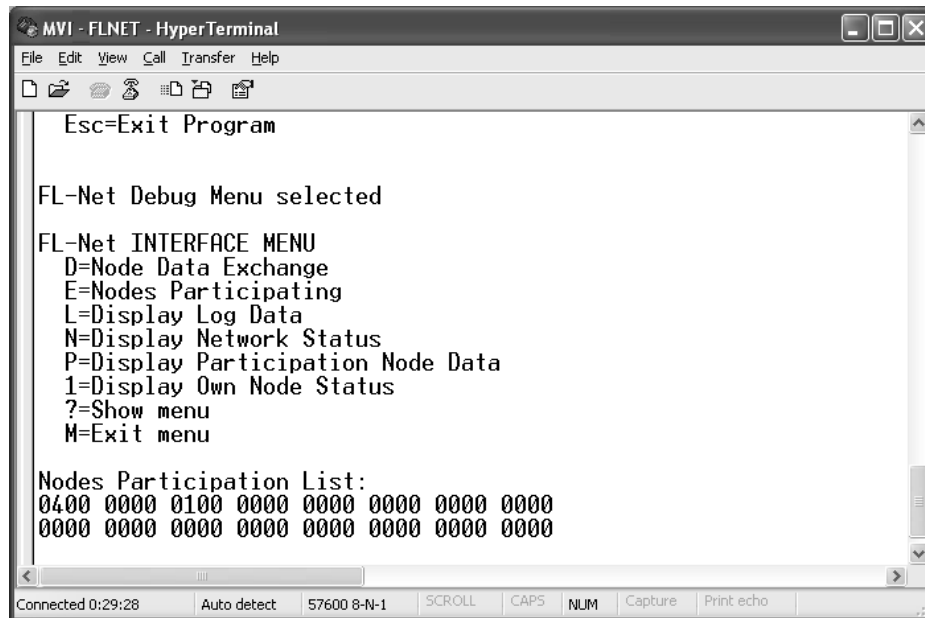

Checking the Log Data

From the Main Menu select:

FL-net Menu (F)→ Display Log Data (L)

The log data menu displays information pertaining to:

- Transmission
- Reception
- Cyclic Transmission

```
FL-Net LOG DATA
Socket Tx      : 14481930      Socket Tx Err : 0
Socket Rx      : 14481845      Socket Rx Err : 0
Tokens Tx      : 7240964       Cyclic Tx      : 7240964
P2P Msg Tx     : 0             BC Msg Tx      : 0
Tokens Rx      : 7240928       Cyclic Rx      : 7240916
P2P Msg Rx     : 0             BC Msg Rx      : 0
Cyclic Rx Err  : 0             Cyc AdSize Er  : 0
Cyc Rx CBN Er  : 0             Cyc Rx TBN Er  : 0
Cyc BSize Er   : 0             Msg Retrans    : 0
Msg Ovr RT     : 0             Msg Rx Err     : 0
Msg Rx Ver Er  : 0             Msg Rx Seq Er  : 0
ACK Errors     : 0             ACK Ver Seq    : 0
ACK Seq Error  : 0             ACK Node # Er  : 0
ACK TCD Error  : 0             Token Mult Er  : 0
Token Discard  : 0             Token Reissue  : 37
Token Hold TO  : 0             Token Mon TO   : 37
Total Serv Tm  : 61939         Frames Waiting : 0
# Participate  : 2             Self-Exits    : 0
Exit By Skip   : 0             Exit of Other  : 0
```

Checking the Participating Node Status

From the Main Menu select:

FL-net Menu (F)→ Display Log Data (P)

Use the navigation keys to navigate between nodes (next, previous, skip forward, skip backward).

```
FL-Net PARTICIPATION NODE DATA MENU
F=Go to node 0
N=Go to next node
P=Go to previous node
+=Skip forward 5 nodes
-=Skip backward 5 nodes
>=Skip forward 10 nodes
<=Skip backward 10 nodes
S=Display Current Node Status
?=Show menu
M=Exit menu
```

The following illustration shows the status for node 10. If the Node Address register indicates a value equal than zero it means that the node is not participating in the network.

```

FL-Net PARTICIPATION NODE 10 DATA:
Node Address   : 10 (0=not participating in network)
TW Time       : 24 (milliseconds)
MFT Time      : 10 100usec units
FA Link Status: 60 (hex)
ULS           : 8000 (hex)
Area 1 --> Top: 50      Size : 50
Area 2 --> Top: 100     Size : 100
Allowed RCT   : 10
Missed Count  : 0
Version Seq # : 28470
Broadcast Seq : 0
P2P Seq #    : 0
My TX Seq #   : 1

```

The Participation Node Data page shows Area 1 and Area 2 settings, FA Link, Upper Layer Status (ULS) and other values for each participating node.

Checking the Own Node Status

From the Main Menu select:

FL-net Menu (F) → Display Own Node Status (1)

```

FL-Net OWN NODE DATA
Node Number    : 40
Area 1 --> Top: 0      Size : 50      End : 49
Area 2 --> Top: 0      Size : 100     End : 99
ULS           : 0000 (hex)
TW Time       : 100 milliseconds
MFT Time      : 10 (100usec units)
Vendor Code   : ProSoft
Vendor Model  : MVI56-FLN
Node Name     : MVI56FLNET
Protocol      : 80 (hex)
FA Link Status: 60 (hex)
Own Status    : 00 (hex)
State         : 7
Tx Ver Seq #  : 2024438129
Broadcast Seq : 1
Msg Active    : No      Msg Resend : 0      Msg Circ : 0

```

The Own Node Data page shows MVI56-FLN status in the FL-net network, including upper layer status, allowable minimum frame interval time (MFT), Area 1 and Area 2 settings, and other values.

1.15.4 Checking Status through ControlLogix Controller Tags

You can also monitor network status through the ControlLogix controller tags that are updated through the MVI56-FLN sample ladder. Refer to the ProSoft Solutions CD-ROM or the ProSoft web site at <http://www.prosoft-technology.com> (<http://www.prosoft-technology.com>) for the sample ladder logic for the MVI56-FLN module.

THE FLNETSTATUS controller tag contains status information that is copied from the module and the processor.

Checking the Own Node Status

Monitor the FLNETSTATUS.Own_node controller tag for MVI56-FLN status information. This tag includes the upper layer status (UL), allowable minimum frame interval time (MFT), token watchdog time (TW), protocol, Area 1 and Area 2 settings for the MVI56-FLN.

The information in this tag is updated automatically from the module through status blocks 0 and -1.

The screenshot shows a software window titled "Controller Tags - MVI56_FLN(controller)". It features a search bar with "Scope: MVI56_FLN(controller)", "Show: Show All", and "Sort: Tag Name". Below is a table with columns for Tag Name, Value, Force Mask, Style, and Type. The table lists various tags under the "FLNETSTATUS.Own_node" category, including node number, protocol, link status, own status, area settings, UL status, TW time, MFT time, vendor code, vendor model, and node name characters.

Tag Name	Value	Force Mask	Style	Type
FLNETSTATUS.Own_node	{...}	{...}		FLNETOwnNodeData
FLNETSTATUS.Own_node.node_number	40		Decimal	SINT
FLNETSTATUS.Own_node.protocol	16#80		Hex	SINT
FLNETSTATUS.Own_node.FA_link_status	16#60		Hex	SINT
FLNETSTATUS.Own_node.Own_status	16#00		Hex	SINT
FLNETSTATUS.Own_node.top_area1	0		Decimal	INT
FLNETSTATUS.Own_node.size_area1	50		Decimal	INT
FLNETSTATUS.Own_node.top_area2	0		Decimal	INT
FLNETSTATUS.Own_node.size_area2	100		Decimal	INT
FLNETSTATUS.Own_node.UL_status	16#0000		Hex	INT
FLNETSTATUS.Own_node.TW_time	100		Decimal	SINT
FLNETSTATUS.Own_node.MFT_time	10		Decimal	SINT
FLNETSTATUS.Own_node.Vendor_code	{...}	{...}	ASCII	SINT[10]
FLNETSTATUS.Own_node.Vendor_model	{...}	{...}	ASCII	SINT[10]
FLNETSTATUS.Own_node.Node_name	{...}	{...}	ASCII	SINT[10]
FLNETSTATUS.Own_node.Node_name[0]	'M'		ASCII	SINT
FLNETSTATUS.Own_node.Node_name[1]	'V'		ASCII	SINT
FLNETSTATUS.Own_node.Node_name[2]	'I'		ASCII	SINT
FLNETSTATUS.Own_node.Node_name[3]	'5'		ASCII	SINT
FLNETSTATUS.Own_node.Node_name[4]	'6'		ASCII	SINT
FLNETSTATUS.Own_node.Node_name[5]	'F'		ASCII	SINT
FLNETSTATUS.Own_node.Node_name[6]	'L'		ASCII	SINT
FLNETSTATUS.Own_node.Node_name[7]	'N'		ASCII	SINT
FLNETSTATUS.Own_node.Node_name[8]	'E'		ASCII	SINT
FLNETSTATUS.Own_node.Node_name[9]	'T'		ASCII	SINT

Checking the Nodes Exchanging Data

Monitor the *FLNETSTATUS.General.Nodes_Exchanging_Data_Table[]* controller tag to see if each node is currently exchanging data. The following illustration shows that only node 10 is currently exchanging data with the MVI56-FLN module: bit 10 of

FLNETSTATUS.General.Nodes_Exchanging_Data_Table[0] word is set to 1 (hex value of 0400). The information in this tag is updated automatically from the module through status blocks 0 and -1.

Tag Name	Value	Force Mask	Style	Type
- FLNETSTATUS.General.Nodes_Exchanging_Data_Table	{...}	{...}	Hex	INT[16]
+ FLNETSTATUS.General.Nodes_Exchanging_Data_Table[0]	16#0400		Hex	INT
+ FLNETSTATUS.General.Nodes_Exchanging_Data_Table[1]	16#0000		Hex	INT
+ FLNETSTATUS.General.Nodes_Exchanging_Data_Table[2]	16#0000		Hex	INT
+ FLNETSTATUS.General.Nodes_Exchanging_Data_Table[3]	16#0000		Hex	INT
+ FLNETSTATUS.General.Nodes_Exchanging_Data_Table[4]	16#0000		Hex	INT
+ FLNETSTATUS.General.Nodes_Exchanging_Data_Table[5]	16#0000		Hex	INT
+ FLNETSTATUS.General.Nodes_Exchanging_Data_Table[6]	16#0000		Hex	INT
+ FLNETSTATUS.General.Nodes_Exchanging_Data_Table[7]	16#0000		Hex	INT
+ FLNETSTATUS.General.Nodes_Exchanging_Data_Table[8]	16#0000		Hex	INT
+ FLNETSTATUS.General.Nodes_Exchanging_Data_Table[9]	16#0000		Hex	INT
+ FLNETSTATUS.General.Nodes_Exchanging_Data_Table[10]	16#0000		Hex	INT
+ FLNETSTATUS.General.Nodes_Exchanging_Data_Table[11]	16#0000		Hex	INT
+ FLNETSTATUS.General.Nodes_Exchanging_Data_Table[12]	16#0000		Hex	INT
+ FLNETSTATUS.General.Nodes_Exchanging_Data_Table[13]	16#0000		Hex	INT
+ FLNETSTATUS.General.Nodes_Exchanging_Data_Table[14]	16#0000		Hex	INT
+ FLNETSTATUS.General.Nodes_Exchanging_Data_Table[15]	16#0000		Hex	INT

Checking the Participation Table

Monitor the *FLNETSTATUS.General.Nodes_Participating_Count* controller tag to see the number of nodes currently participating in the network. The information in this tag is updated automatically from the module through status blocks 0 and -1.

Monitor the *FLNETSTATUS.General.Nodes_Participating_Table[]* controller tag to check if each node is currently participating in the FL-net network. The following illustration shows that only nodes 10 and 40 are participating.

- Bit 10 of *FLNETSTATUS.General.Nodes_Exchanging_Data_Table[0]* word is set as 1 (hex value of 0400)
- Bit 8 of *FLNETSTATUS.General.Nodes_Exchanging_Data_Table[2]* word is set as 1 (hex value of 0100).
- Bit 8 of *FLNETSTATUS.General.Nodes_Exchanging_Data_Table[2]* corresponds with bit 40 for the entire participating table.

The following illustration shows that currently there are 2 nodes participating.

Tag Name	Value	Force Mask	Style	Type
+ FLNETSTATUS.General.Nodes_Participating_Count	2		Decimal	INT
- FLNETSTATUS.General.Nodes_Participating_Table	{ ... }	{ ... }	Hex	INT[16]
+ FLNETSTATUS.General.Nodes_Participating_Table[0]	16#0400		Hex	INT
+ FLNETSTATUS.General.Nodes_Participating_Table[1]	16#0000		Hex	INT
+ FLNETSTATUS.General.Nodes_Participating_Table[2]	16#0100		Hex	INT
+ FLNETSTATUS.General.Nodes_Participating_Table[3]	16#0000		Hex	INT
+ FLNETSTATUS.General.Nodes_Participating_Table[4]	16#0000		Hex	INT
+ FLNETSTATUS.General.Nodes_Participating_Table[5]	16#0000		Hex	INT
+ FLNETSTATUS.General.Nodes_Participating_Table[6]	16#0000		Hex	INT
+ FLNETSTATUS.General.Nodes_Participating_Table[7]	16#0000		Hex	INT
+ FLNETSTATUS.General.Nodes_Participating_Table[8]	16#0000		Hex	INT
+ FLNETSTATUS.General.Nodes_Participating_Table[9]	16#0000		Hex	INT
+ FLNETSTATUS.General.Nodes_Participating_Table[10]	16#0000		Hex	INT
+ FLNETSTATUS.General.Nodes_Participating_Table[11]	16#0000		Hex	INT
+ FLNETSTATUS.General.Nodes_Participating_Table[12]	16#0000		Hex	INT
+ FLNETSTATUS.General.Nodes_Participating_Table[13]	16#0000		Hex	INT
+ FLNETSTATUS.General.Nodes_Participating_Table[14]	16#0000		Hex	INT
+ FLNETSTATUS.General.Nodes_Participating_Table[15]	16#0000		Hex	INT

Checking the Participating Node Status

To retrieve the participation node status, the processor must request special block 2000 (Participation Table Request) from the module. This special block transfer request allows the processor to retrieve status information for each participating node. Status registers include:

- upper layer status (ULS)
- allowable minimum frame interval time (MFT)
- allowable refresh cycle time (RCT)
- Area 1 (A1) and Area 2 (A2) settings
- token watchdog time (TW).

Each block can retrieve status for up to 10 participating nodes. The user application must initially select the number of nodes to retrieve (up to 10) and the first node address to retrieve.

For example, to retrieve the status for participating node address 10 (1 node only), set the controller tags as shown in the following illustrations:

Tag Name	Value	Force Mask	Style	Type	Description
+ FLNETMODULE.CONTROL.GetParticipation_NodeCount	1		Decimal	INT	
+ FLNETMODULE.CONTROL.GetParticipation_FirstNode	10		Decimal	INT	

The next step is to trigger the Participation Table Request block (block 2000). To do this, set the *FLNETMODULE.CONTROL.GetParticipation* bit to 1. The following rung in the sample ladder WriteData routine performs the request to the module. The *FLNETMODULE.CONTROL.GetParticipation* bit is automatically cleared after the response is received from the module.

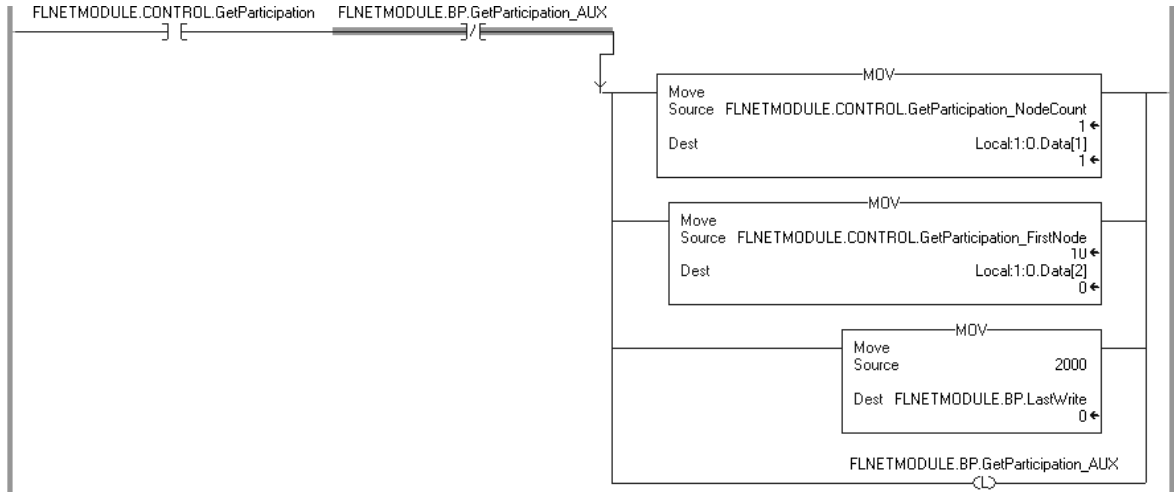

The following rung in the Read Data routine reads the module response containing the participating node status.

Note: The sample ladder will copy the status for 10 nodes. Edit this logic according to the number of nodes to be read for your application.

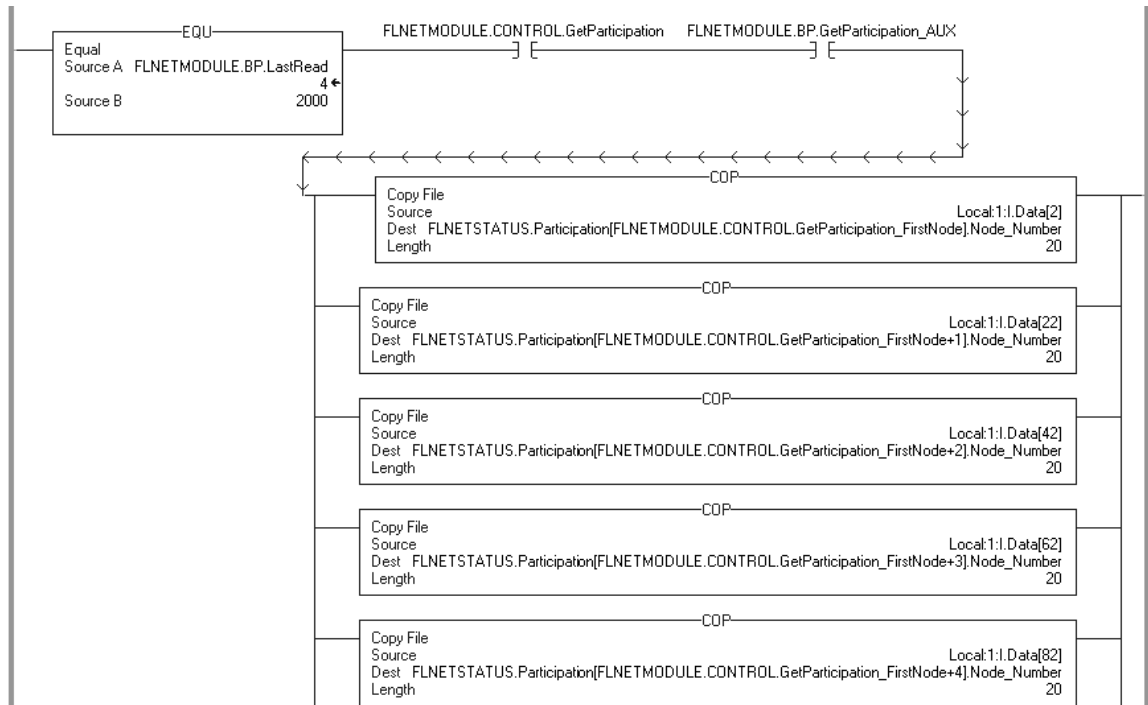

The participating node status is read to the *FLNETSTATUS.Participation[]* controller tag array. The status for node address 10 is available at *FLNETSTATUS.Participation[0]*.

Tag Name	Value	Force Mask	Style	Type
- FLNETSTATUS.Participation	{...}	{...}		FLNETNo...
+ FLNETSTATUS.Participation[0]	{...}	{...}		FLNETNo...
+ FLNETSTATUS.Participation[1]	{...}	{...}		FLNETNo...
+ FLNETSTATUS.Participation[2]	{...}	{...}		FLNETNo...
+ FLNETSTATUS.Participation[3]	{...}	{...}		FLNETNo...
+ FLNETSTATUS.Participation[4]	{...}	{...}		FLNETNo...
+ FLNETSTATUS.Participation[5]	{...}	{...}		FLNETNo...
+ FLNETSTATUS.Participation[6]	{...}	{...}		FLNETNo...
+ FLNETSTATUS.Participation[7]	{...}	{...}		FLNETNo...
+ FLNETSTATUS.Participation[8]	{...}	{...}		FLNETNo...
+ FLNETSTATUS.Participation[9]	{...}	{...}		FLNETNo...
- FLNETSTATUS.Participation[10]	{...}	{...}		FLNETNo...
+ FLNETSTATUS.Participation[10].Node_Number	10		Decimal	INT
+ FLNETSTATUS.Participation[10].Node_Active_Number	10		Decimal	INT
+ FLNETSTATUS.Participation[10].TW_time	24		Decimal	INT
+ FLNETSTATUS.Participation[10].MFT	10		Decimal	INT
+ FLNETSTATUS.Participation[10].FL_status	16#0060		Hex	INT
+ FLNETSTATUS.Participation[10].IULS	16#8000		Hex	INT
+ FLNETSTATUS.Participation[10].Top_A1	50		Decimal	INT
+ FLNETSTATUS.Participation[10].Size_A1	50		Decimal	INT
+ FLNETSTATUS.Participation[10].Top_A2	100		Decimal	INT
+ FLNETSTATUS.Participation[10].Size_A2	100		Decimal	INT
+ FLNETSTATUS.Participation[10].RCT	11		Decimal	INT
+ FLNETSTATUS.Participation[10].Missed_count	0		Decimal	INT
+ FLNETSTATUS.Participation[10].RX_Ver_Seq	75070		Decimal	DINT
+ FLNETSTATUS.Participation[10].RX_BC_Seq	0		Decimal	DINT
+ FLNETSTATUS.Participation[10].RX_P2P_Seq	0		Decimal	DINT
+ FLNETSTATUS.Participation[10].Tx_P2P_Seq	1		Decimal	DINT

Checking the Log Data

To retrieve the Log Data, the processor must request special block 9250 (Log Data Block) from the module.

The following rung in the Write Data routine requests block 9250. To trigger this logic, set the *FLNETMODULE.CONTROL.GetParticipation* bit to 1.

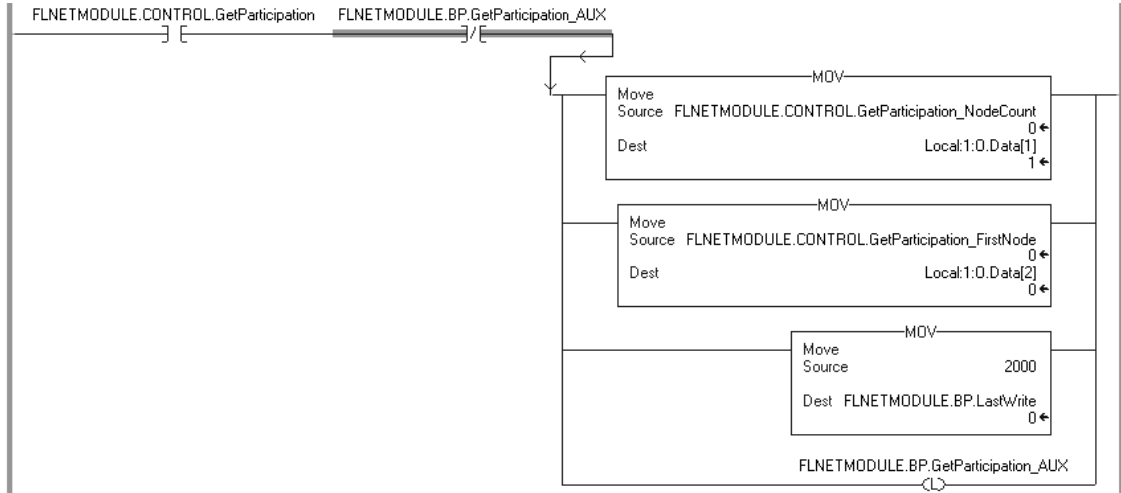

The processor will eventually receive the block response from the module, and the following rung in the Write Data routine will automatically clear the *FLNETMODULE.CONTROL.GetParticipation* bit and read the block response to the correct tags.

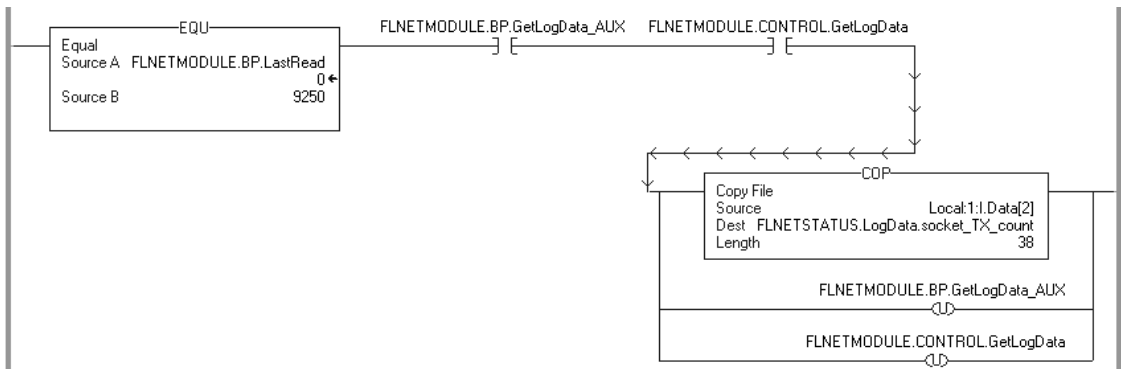

You can view the Log Data read from the module in the *FLNETSTATUS.LogData* controller tag, as shown in the following illustration:

Tag Name	Value	Force Mask	Style	Type
FLNETSTATUS.LogData	{...}	{...}		FLNETLo...
FLNETSTATUS.LogData.socket_TX_count	589381		Decimal	DINT
FLNETSTATUS.LogData.socket_TX_error_count	0		Decimal	DINT
FLNETSTATUS.LogData.socket_RX_count	589378		Decimal	DINT
FLNETSTATUS.LogData.socket_RX_error_count	0		Decimal	DINT
FLNETSTATUS.LogData.tokens_TX	294690		Decimal	DINT
FLNETSTATUS.LogData.cyclic_TX	294690		Decimal	DINT
FLNETSTATUS.LogData.p2p_msg_TX	0		Decimal	DINT
FLNETSTATUS.LogData.BC_msg_TX	0		Decimal	DINT
FLNETSTATUS.LogData.tokens_RX	294688		Decimal	DINT
FLNETSTATUS.LogData.cyclic_RX	294688		Decimal	DINT
FLNETSTATUS.LogData.p2p_msg_RX	0		Decimal	DINT

Checking the General Network Status

Monitor the *FLNETSTATUS.Network* for general FL-net network information:

- the token node that is currently holding the token
- the refresh cycle measurement time (RMT) - minimum, maximum and current values
- allowable minimum frame interval time (MFT)
- allowable refresh cycle time (RCT).

This information is available in the *FLNETSTATUS.Network* controller tag.

Tag Name	Value	Force Mask	Style	Type
FLNETSTATUS.Network	{...}	{...}		FLNET...
FLNETSTATUS.Network.token_node_number	40		Decimal	SINT
FLNETSTATUS.Network.MFT_time	10		Decimal	SINT
FLNETSTATUS.Network.RTL_time	9		Decimal	INT
FLNETSTATUS.Network.RMT_current	9		Decimal	INT
FLNETSTATUS.Network.RMT_max	30		Decimal	INT
FLNETSTATUS.Network.RMT_min	6		Decimal	INT

Checking the Backplane status

Monitor the FLNETSTATUS.Backplane controller tag for information about backplane status.

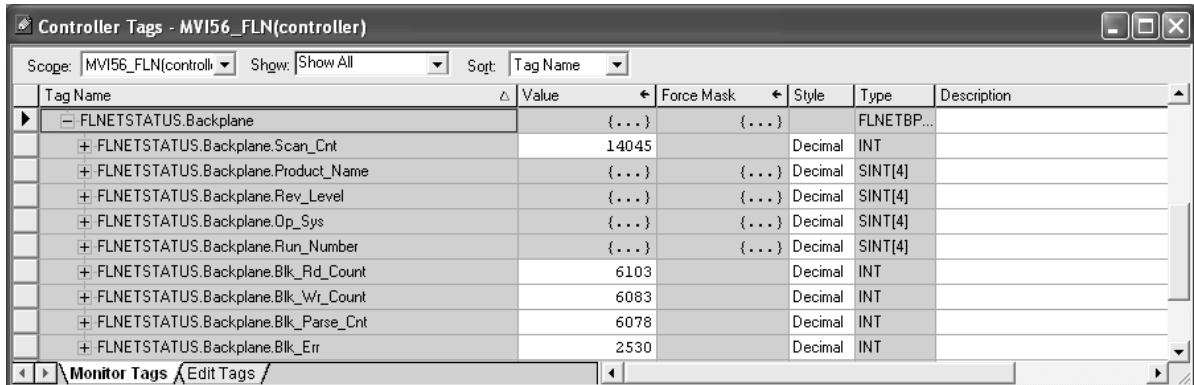

Tag Name	Value	Force Mask	Style	Type	Description
FLNETSTATUS.Backplane	{...}	{...}		FLNETBP...	
+ FLNETSTATUS.Backplane.Scan_Cnt	14045		Decimal	INT	
+ FLNETSTATUS.Backplane.Product_Name	{...}	{...}	Decimal	SINT[4]	
+ FLNETSTATUS.Backplane.Rev_Level	{...}	{...}	Decimal	SINT[4]	
+ FLNETSTATUS.Backplane.Op_Sys	{...}	{...}	Decimal	SINT[4]	
+ FLNETSTATUS.Backplane.Run_Number	{...}	{...}	Decimal	SINT[4]	
+ FLNETSTATUS.Backplane.Blk_Rd_Count	6103		Decimal	INT	
+ FLNETSTATUS.Backplane.Blk_Wr_Count	6083		Decimal	INT	
+ FLNETSTATUS.Backplane.Blk_Parse_Cnt	6078		Decimal	INT	
+ FLNETSTATUS.Backplane.Blk_Err	2530		Decimal	INT	

1.15.5 Transferring Data

The sample ladder logic automatically updates the data with the *FLNETDATA.Output* and *FLNETDATA.Input* controller tags. The Area 1 data is divided into blocks 1 to 3. The Area 2 data is divided into blocks 4 to 35. Each block contains up to 240 words of data.

The data received from the remote FL-net node to the MVI56-FLN module is automatically "reassembled" from the input blocks into the *FLNETDATA.Input* controller tag (according to each block ID). Also, the data to transfer from the module to the remote FL-net node is copied from the *FLNETDATA.Output* controller tag into the output blocks according to its block ID. This logic is already handled by the sample ladder program supplied by ProSoft.

For this example, use the following MVI56-FLN Area1 and Area 2 settings in the FLNET.CFG configuration file:

```

Area 1 Top      : 0 #0...511 top address for area 1
Area 1 Size    : 50 #0...512 area 1 data size in words (0=not used)
Area 2 Top      : 0 #0...8191 top address for area 1
Area 2 Size    : 100 #0...8192 area 2 data size in words (0=not used)
BP Area 1 Top  : 50 #0...511 top address for area 1
BP Area 1 Size: 50 #0...512 area 1 data size in words (0=none transferred)
BP Area 2 Top  : 100 #0...8191 top address for area 1
BP Area 2 Size: 100 #0...8192 area 2 data size in words (0=none transferred)

```

Important: The module only generates the blocks required to transfer the data you configured. For this example only one Area 1 block and one Area 2 blocks are required, so only blocks 1 to 4 are used for data transfer. The larger the areas, the more blocks are required to transfer data (and the more time is required to update the whole block).

In this example, configure the FL/ET-T-V2 module with the values in the following illustration:

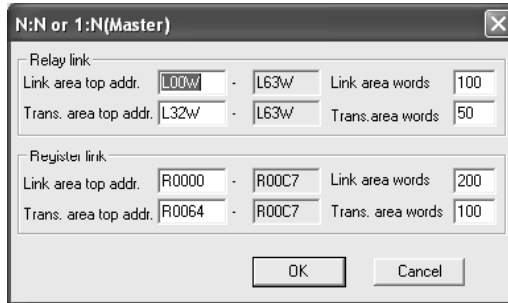

Transferring Data from MVI56-FLN (Area 1) to FL/ET-T-V2 module (Relay Area)

The *FLNETDATA.Output.Area1* controller tags transfer data from the module Area 1 to the remote FL-net node Relay link area. For this example, use the values in the following illustration:

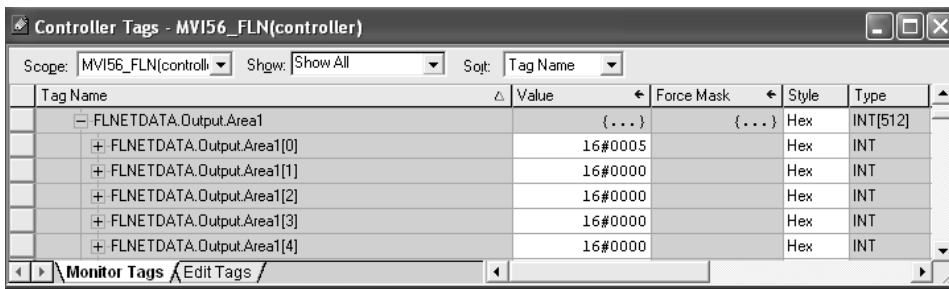

Use the PCWin Register Address Monitor to monitor the value set by the module (address L00W for our example).

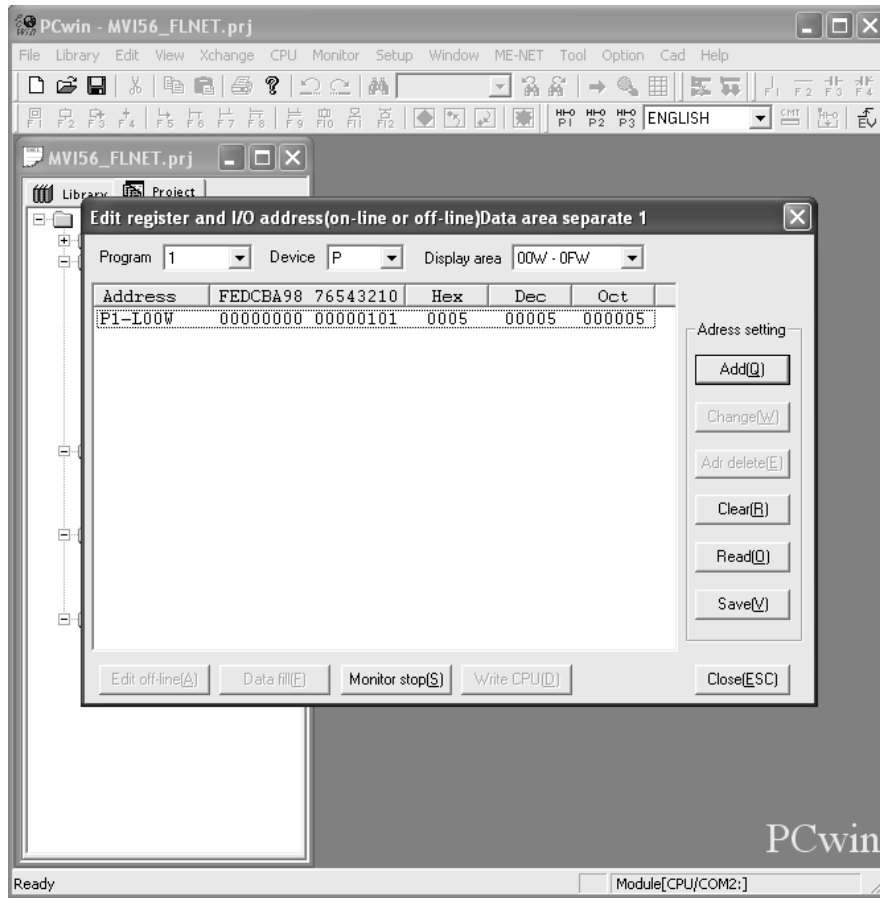

Transferring Data from FL/ET-T-V2 Link Area to MVI56-FLN Area 1

Use the PCWin Register Address Monitor to set the value to transfer to the module (address L32W for this example)

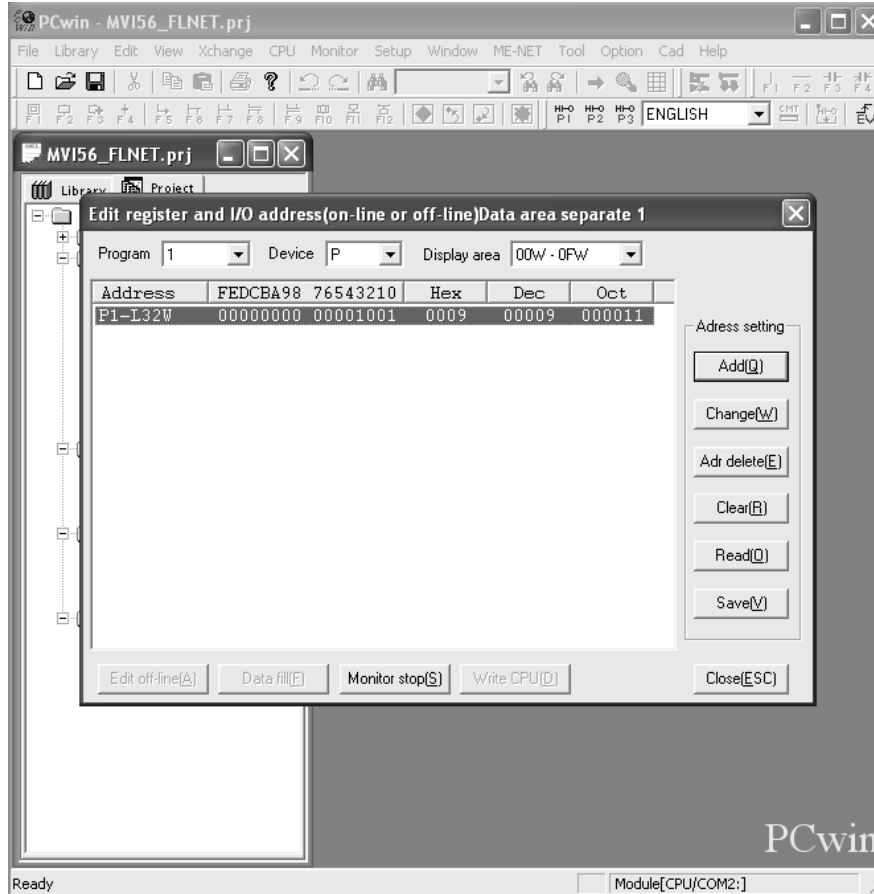

Use *FLNETDATA.Input.Area1* controller tags to monitor data received from the remote node to the MVI56-FLN Area 1.

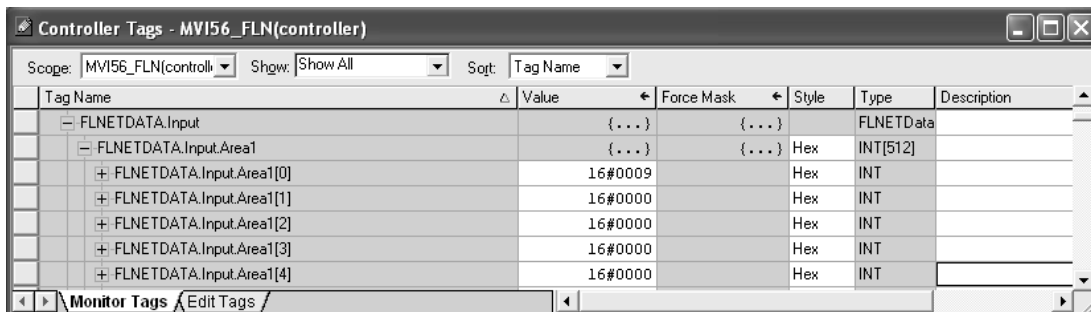

Transferring Data from MVI56-FLN (Area 2) to FL/ET-T-V2 module (Register Area)

Use the *FLNETDATA.Output.Area2* controller tags to transfer data from the module Area 1 to the remote FL-net node Relay link area. For this example, use the values in the following illustration:

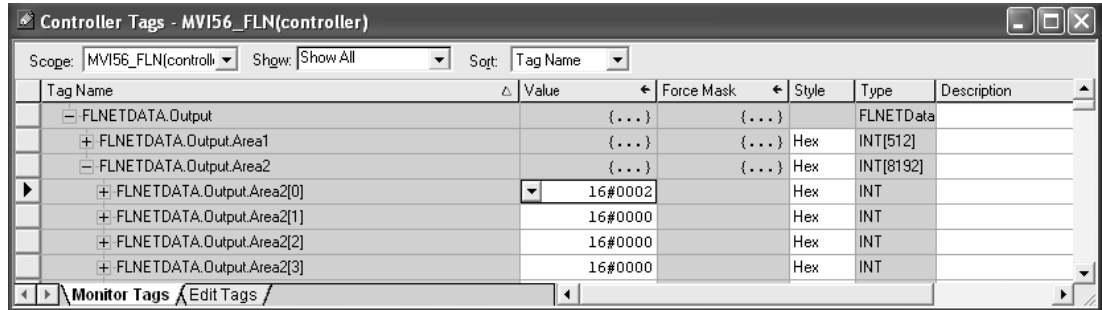

Use the PCWin Register Address Monitor to monitor the value set by the module (address R000 for our example).

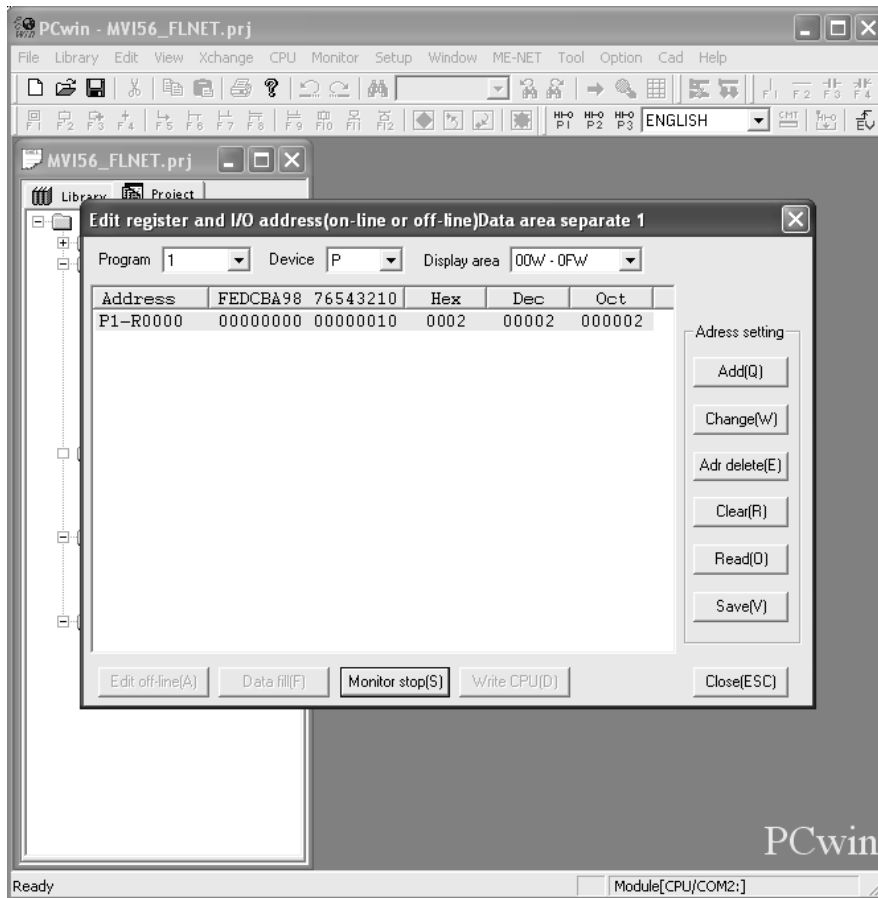

Transferring Data from FL/ET-T-V2 Register Area to MVI56-FLN Area 2

Use the PCWin Register Address Monitor to set the value to transfer to the module (address R0064 for this example)

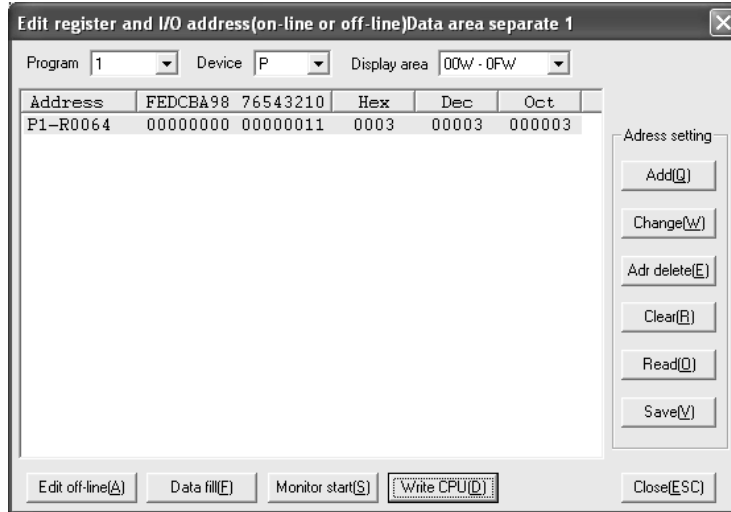

Use the *FLNETDATA.Input.Area2* controller tags to monitor data received from the remote node to the MVI56-FLN Area 2.

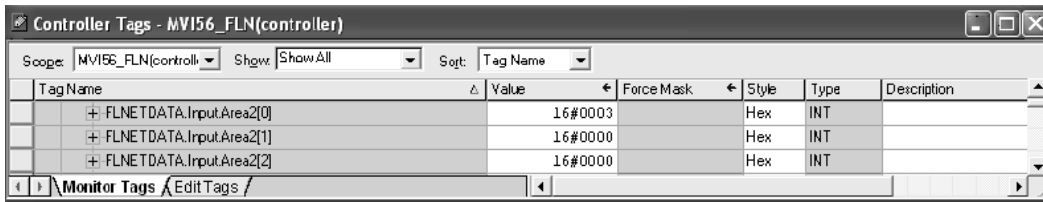

2 Diagnostics and Troubleshooting

In This Chapter

❖ Required Hardware	67
❖ The Configuration/Debug Menu	68
❖ Basic Ethernet	70
❖ LED Status Indicators	70
❖ Ethernet LED Indicators	71
❖ Troubleshooting.....	71

The module provides information on diagnostics and troubleshooting in the following forms:

- Status data values are transferred from the module to the processor.
- Data contained in the module can be viewed through the Configuration/Debug port attached to a terminal emulator.
- LED status indicators on the front of the module provide information on the module's status.

2.1 Required Hardware

You can connect directly from your computer's serial port to the serial port on the module to view configuration information, perform maintenance, and send (upload) or receive (download) configuration files.

ProSoft Technology recommends the following minimum hardware to connect your computer to the module:

- 80486 based processor (Pentium preferred)
- 1 megabyte of memory
- At least one UART hardware-based serial communications port available. USB-based virtual UART systems (USB to serial port adapters) often do not function reliably, especially during binary file transfers, such as when uploading/downloading configuration files or module firmware upgrades.
- A null modem serial cable.

2.2 The Configuration/Debug Menu

The Configuration and Debug menu for this module is arranged as a tree structure, with the Main Menu at the top of the tree, and one or more sub-menus for each menu command. The first menu you see when you connect to the module is the Main menu.

Because this is a text-based menu system, you enter commands by typing the command letter from your computer keyboard in the diagnostic window in ProSoft Configuration Builder (PCB). The module does not respond to mouse movements or clicks. The command executes as soon as you press the command letter — you do not need to press **[Enter]**. When you type a command letter, a new screen will be displayed in your terminal application.

2.2.1 Using the Diagnostic Window in ProSoft Configuration Builder

To connect to the module's Configuration/Debug serial port:

- 1 Start PCB program with the application file to be tested. Right click over the module icon.

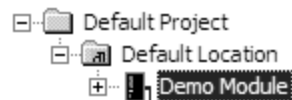

- 2 On the shortcut menu, choose Diagnostics.

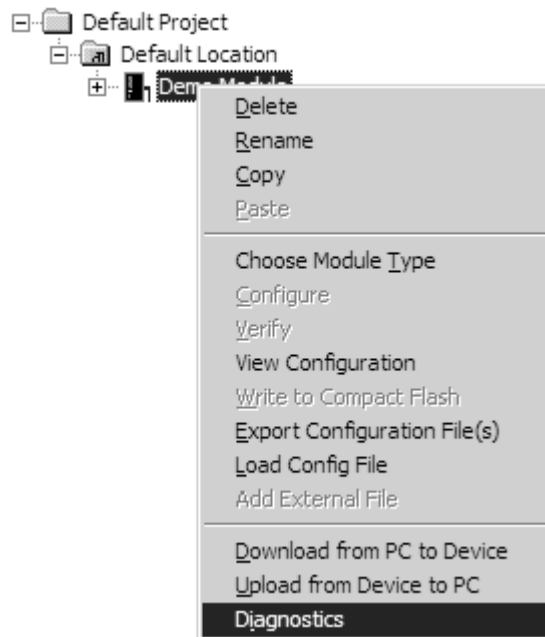

- This action opens the Diagnostics dialog box. Press "?" to display the Main Menu.

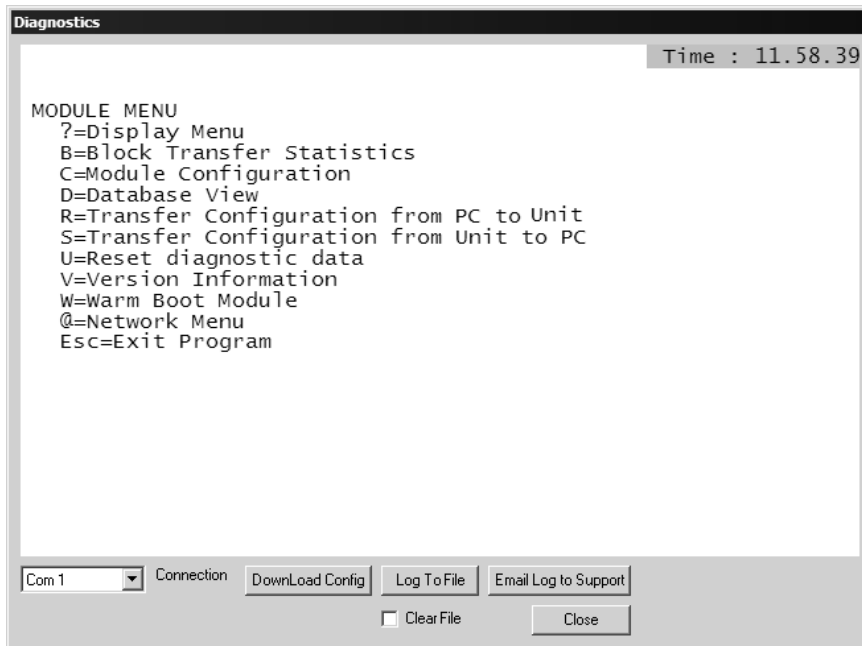

Important: The illustrations of configuration/debug menus in this section are intended as a general guide, and may not exactly match the configuration/debug menus in your own module.

If there is no response from the module, follow these steps:

- Verify that the null modem cable is connected properly between your computer's serial port and the module. A regular serial cable will not work.
- On computers with more than one serial port, verify that your communication program is connected to the same port that is connected to the module.

If you are still not able to establish a connection, contact ProSoft Technology for assistance.

2.2.2 Navigation

All of the sub-menus for this module contain commands to redisplay the menu or return to the previous menu. You can always return from a sub-menu to the next higher menu by pressing **[M]** on your keyboard.

The organization of the menu structure is represented in simplified form in the following illustration:

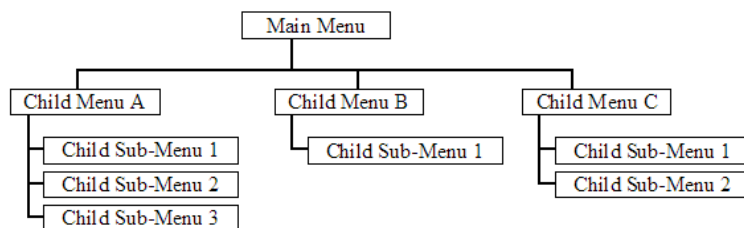

The remainder of this section shows you the menus available for this module, and briefly discusses the commands available to you.

Keystrokes

The keyboard commands on these menus are almost always non-case sensitive. You can enter most commands in lower case or capital letters.

The menus use a few special characters ([**?**], [**-**], [**+**], [**@**]) that must be entered exactly as shown. Some of these characters will require you to use the [**Shift**], [**Ctrl**] or [**Alt**] keys to enter them correctly. For example, on US English keyboards, enter the [**?**] command as [**Shift**]/.

Also, take care to distinguish capital letter [**I**] from lower case letter [**i**] (L) and number [**1**]; likewise for capital letter [**O**] and number [**0**]. Although these characters look nearly the same on the screen, they perform different actions on the module.

2.3 Basic Ethernet

The Ethernet Unit is provided with a variety of troubleshooting functions for prompt recovery in case of errors.

- Self-diagnostic function at startup
- PING command for checking other nodes
- Inter-nodal tests for checking other nodes
- Error log for recording error history data

2.4 LED Status Indicators

LED	Description
COM	Indicates Receive / Transmit activity on the Ethernet interface.
LE	Communication Error and FA Link present. This LED is illuminated when any of the following conditions exist: <ul style="list-style-type: none"> ▪ Bad frame recognized on FA Link ▪ Error recognized on FA Link Own Status Errors: <ul style="list-style-type: none"> ▪ Watchdog timeout error ▪ Receive wait error Link Status Errors: <ul style="list-style-type: none"> ▪ Out-ringed ▪ Communication invalidity bit set
ER	This LED indicates several conditions. If the LED illuminates solid green, there are no error conditions recognized. If the LED illuminates solid red, there is a major problem with the module and it may need to be replaced. If the LED blinks red and green, there is a parameter error present. The conditions which cause a parameter error are as follows: <ul style="list-style-type: none"> Own Status Errors: <ul style="list-style-type: none"> ▪ Node duplication address detected ▪ Initialization error Link Status Errors: <ul style="list-style-type: none"> ▪ Address overlap error

LED	Description
BP ACT	This LED indicates backplane activity. The LED should flash very quickly when backplane activity is present.
BATT	The battery voltage is low or battery is not present. Allow battery to charge by keeping module plugged into rack for 24 hours. If BAT LED still does not go off, contact ProSoft Technology, as this is not a user serviceable item.
LINK	This LED on the Ethernet port indicates that the module recognizes the connection to the hub or switch.

2.5 Ethernet LED Indicators

LED	State	Description
Data	Off	No activity on the port.
	Green Flash	The port is either actively transmitting or receiving data.
Link	Off	No connection to hub or network is detected.
	Green Solid	Connected to hub or network correctly. This is the normal operating state.

2.6 Troubleshooting

2.6.1 Own-Node Status information

The Own Node Status register (displayed on the Own Node Status menu) contains the following information:

Own Status Byte

Bit	Message	Description	Value
0	Node address duplicate (1=Error)	Indicates the management information on node number conflicted to see whether any node having the same node number as the self node setting exists on the network or not.	0x0001
1	TW Error (1=Error)	Token watchdog time error flag indicates that transmission processing fails to complete within the token watchdog time set in the own node	0x0002
2	Rx Wait Error (1=Error)	Indicates that no frame has been received at network initialization, being a frame receive waiting status.	0x0004
3	Initialization Error (1=Error)	Indicates an error is found in an initial setting or resetting parameter	0x0008
4	Reserved		0x0010
5	Reserved		0x0020
6	Reserved		0x0040
7			0x0080

Link Status Byte

The FA-Link Status register (displayed on the Own Node Status menu) contains the following information:

Bit	Message	Description	Value
0	*Node Status (1=Out-ring, 0=In-ring)	Indicates whether the node is in-ringed or out-ringed	0x0001
1	*Communication Invalid (1=Yes, 0=No)		0x0002
2	Always 0		0x0004
3	Always 0		0x0008
4	Upper Layer Error Signal (1=Error)	Indicates that the updating of the existence signal of the upper layer cannot be recognized	0x0010
5	Common Memory Valid (1=Valid)	Indicates the cycle data is valid	0x0020
6	Common Memory Set (1=Complete)	Indicates that the setting in the common memory of the node is completed	0x0040
7	Address Overlap (1=Error,0=No Error)	Indicates that there is a duplication in the common memory among the nodes connected to the network	0x0080

*Only reported to the processor and not network where these bits are always clear.

Upper Layer Status Word

The Upper Layer Status can be set by the ControlLogix processor or the module. Refer to Upper Layer Status Read Definition (page 90) for more information.

Bit	Message	Description		Value
0 to 11	Error Code (User Defined)			0x0001
12	reserved			0x1000
13	1=Warning, 0=No Warning	Bit 15 = 1 The upper layer program is running with an error but both cyclic data and message data are guaranteed.	Bit 15 = 0 The upper layer program is at a stop with an error but both cyclic data and message data are guaranteed.	0x2000
14	1=Alarm, 0=No Alarm	Both cyclic data and message data are not guaranteed.	Both cyclic data and message data are not guaranteed.	0x4000
15	1=Run, 0=Stop	Run	Stop	0x8000

3 Reference

In This Chapter

❖ Product Specifications	73
❖ Functional Overview	75
❖ Implementation of FL-net.....	87
❖ FL-net Node Configuration Parameters.....	96
❖ FL-net Protocol and network	98
❖ Error and Status Data.....	109
❖ FL-net Device Profile for MVI56-FLN Module.....	110
❖ Communications Management Tables	113
❖ State Transition Diagram.....	115
❖ Glossary	125

3.1 Product Specifications

3.1.1 Product Description

The MVI56-FLN FA Control Network communication module is a single slot solution that allows Allen-Bradley ControlLogix I/O compatible processors to easily interface with other FL-net protocol compatible devices. The module implements FL-net version 2.00 (OPCN-2) defined by JEMA (The Japan Electrical Manufacturers Association) for the standard FA control network. FL-net is a master-less system and is specified for a 50 millisecond cycle time for 32 nodes and up to 254 nodes can be addressed.

The MVI56-FLN module acts as a gateway between the FL-net network and the Allen-Bradley backplane. The data transfer from the ControlLogix processor is asynchronous from the actions on the FL-net network. The module's internal database can be used to exchange up to 512 words of Area 1 cyclic data, and 8192 words of Area 2 cyclic data between the processor and the FL-net network.

3.1.2 Features

General features include:

FL-net systems have the following features.

- 1 FL-net is an open system.
- 2 FL-net enables a multi-vendor network.
- 3 FL-net enables personal computers and FA controllers, such as programmable controllers (PLCs) or computerized numeric controllers (CNCs), by different manufacturers to be interconnected, controlled, and monitored.
 - Master-less token control method.

- FA link protocol on Ethernet UDP / IP.
- Cyclic data transfer: Supports virtual memory Area 1 (512 words) and Area 2 (8192 words). The cyclic data is mapped to the modules I/O area.
- Message transfer:
 - Server Functionality
 - Log data read service
 - Log data clear service
 - Network Parameter Read
 - Profile Read
 - Return Message
- Network Management Table: According to FL-net version 2.00 specification.
- Own-node Management Table: According to FL-net version 2.00 specification.
- Participating Node Management Table: According to FL-net version 2.00 specification.
- Network configurable via a text file or ProSoft Technology Configuration Builder Software
- Status and Error information

The MVI56-FLN module provides highly configurable FL-net capabilities to the Allen-Bradley ControlLogix platform. FL-net (OPCN-2) is a controller-level network conforming to specification Japan Electrical manufacturers Association JEM1479. Developed by to focus on multi-vendor communications of programmable controllers, NC controllers, Robotic and other Motion Control systems.

3.1.3 Functional Specifications

The MVI56-FLN module accepts commands to control and monitor the data stored in the databases. This data is passed between the module and the ControlLogix processor over the backplane for use in user applications.

Physical

- ControlLogix Form Factor - Single Slot
- Connections:
 - 1 - RJ45 10BaseT 10 Mbps connection to the Ethernet network
 - 1 - RJ45 RS-232 Configuration Tool Connector

ControlLogix Interface

- Operation via simple ladder logic
- Complete set up and monitoring of module through RSLogix 5000 software
- ControlLogix backplane interface via I/O access
- All data is contained in a single controller tag
- All status data is contained in a single controller tag with defined objects to simplify configuration, monitoring, and communication with the module

3.2 Functional Overview

3.2.1 About FL-net Protocol

FL-net is an open FA network that was standardized by the Japan FA Open Systems Promotion Group (JOP) of the Manufacturing Science and Technology Center (MSTC) under the Ministry of International Trade and Industry (MITI). It has been established in the Japan Electrical Manufacturers standards (JEM 1479) and is becoming very popular.

FL-net enables personal computers and FA controllers, such as programmable controllers (PLCs) or computerized numeric controllers (CNCs), by different manufacturers to be interconnected, controlled, and monitored, as shown in the following illustration.

The following figure shows the positioning of the FL-net.

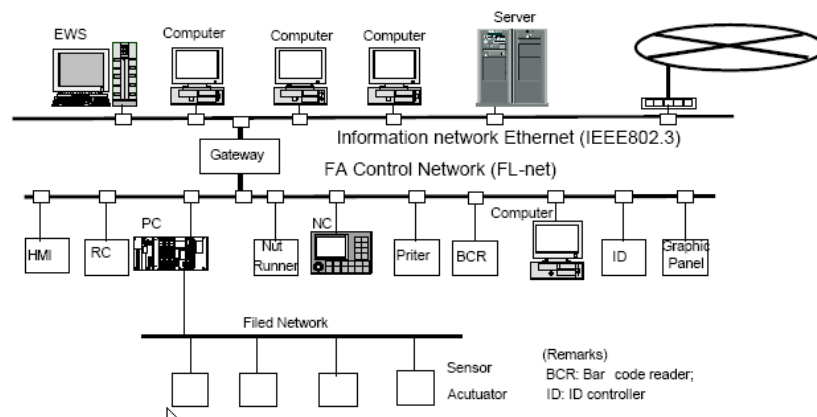

FL-net (Version 2.00) Unit specifications have been designed to conform to Japan Electrical Manufacturers standards (JEM 1479: 2001). It cannot be connected to communications devices based on the previous standards (JEM 1479: 2000).

The most recent FL-net specifications can be downloaded from the home page of the Japan Electrical Manufacturers Association (http://www.jema-net.or.jp/Japanese/hyojun/opcn_e/opcn07.htm) (http://www.jema-net.or.jp/japanese/hyojun/opcn_e/opcn07.htm)

User-defined Specifications

- 1 User-defined specifications allow the following range of features that are required for FA systems.
- 2 Large-scale network

Up to 254 devices (nodes) can be connected in the physical layer of the network.

"1 through 254" shall be used as node number. However, numbers "250 through 254" are reserved for maintenance purposes. Number "0" shall not be used.

Number "255" shall be used as the global address for broadcasting.

3 Dual communications functions to suit application

The Common Memory function uses cyclic transmission so that each node can always share the same data with other nodes on the network. FL-net also supports message communications for use when handling only essential data is required.

4 Large-capacity Common Memory

The Common Memory is provided with a large capacity of 8K bits (Area 1) and 8K words (Area 2).

5 High-speed response

High-speed response time of 50 milliseconds / 32 nodes (for 2K bits and 2K words) is provided. The absence of a master in the FL-net network enables nodes to be added or removed readily without affecting any other nodes. This allows any node to be turned ON or OFF easily and facilitates maintenance.

The FL-net protocol is characterized by the following items:

- 1** Transmission control using masterless token system avoids collision.
- 2** Refresh cycle time can be specified since the system circulates a token in a fixed time.
- 3** The token is transmitted together with a cyclic data.
- 4** The node with a smallest node number among those who participate the network at start-up time shall start to send the token.
- 5** If no token is transmitted for a specified period, next node in the token circulation ring shall send a new token.
- 6** The masterless token system (characterized by the above two items) will keep the network from stopping in case of failure of some nodes.
- 7** The protocol provides information management tables for useful information to refer operation status of other nodes such as operation mode (RUN / STOP) and hardware malfunction (ALARM).

Data Communication Between Nodes

Types of Data Communication

The FL-net protocol supports 2 types of data communication.

- 1** Cyclic transmission for cyclic data transmission
- 2** Message transmission for non-cyclic data transmission

Cyclic transmission

The common memory size is 8k bits + 8k words = 8.5k words in a whole network.

Available amount of transmission data in one node is 8.5k words at maximum.

One word consists of 2 bytes.

Message transmission

Maximum data length of one message frame is 1024 bytes (excluding header).

Cyclic Transmission Function

Cyclic transmission means a function that supports cyclic data exchange between nodes.

Basic functions

- 1 The cyclic transmission implements common memory interface.
- 2 Each node sends its whole data while it holds the token.
- 3 Nodes having no cyclic data are acceptable.

Common memory

- 1 The common memory interface provides nodes with a service that can be regarded as a memory shared among them.
- 2 Two area types (Area 1 and Area 2) may be assigned for a node.
- 3 Multiple frames may be used if the transmitting area size of a node exceeds the transmission size of one frame, that is, 1024 bytes.
- 4 The common memory will not update itself with receiving data until all frames from a node are successfully received in case of the item (3). Thus time coherency of data from a node is guaranteed.
- 5 Communication unit of each node shall provide fixed area of 8k bits + 8k words = 8.5k words as the common memory.
- 6 Both Area 1 and Area 2 can be set at any size within the maximum.

Data Share Function

Each node on a FL-net has specific transmission area in the common memory that does not overlap with others. A transmission area assigned to one node must be receiving area for other nodes.

Each node broadcasts its data in a fixed cycle and all the nodes in a network share the same data on the common memory.

Common Memory Function

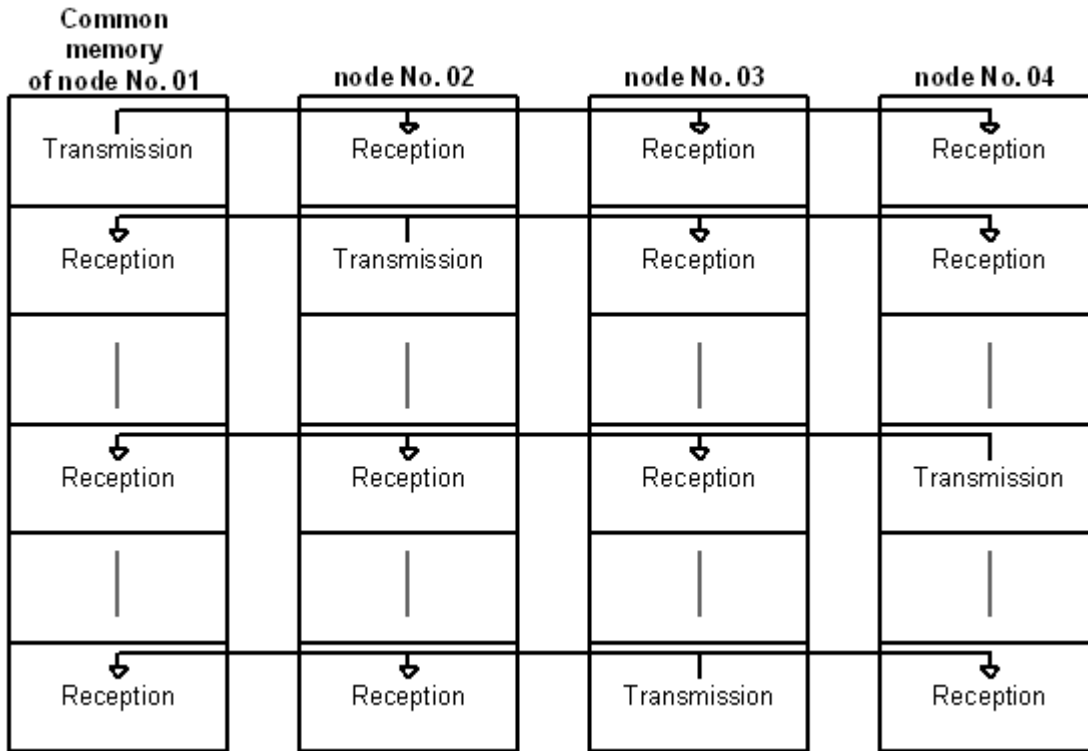

A node can use the whole common memory as receiving area.

Node for Reception Only

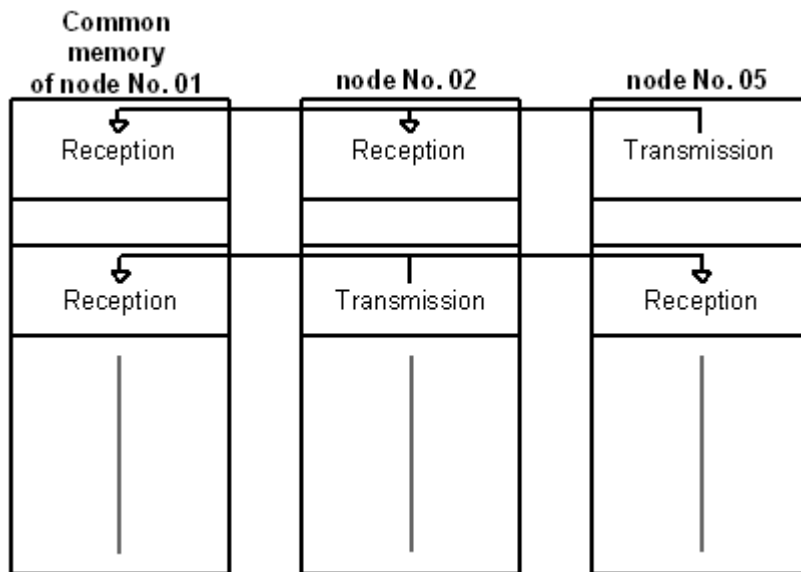

The FA link protocol allows the existence of nodes which do not have common memory because there is no transmission and reception data of cyclic but message transmission only.

Node Having No Common Memory

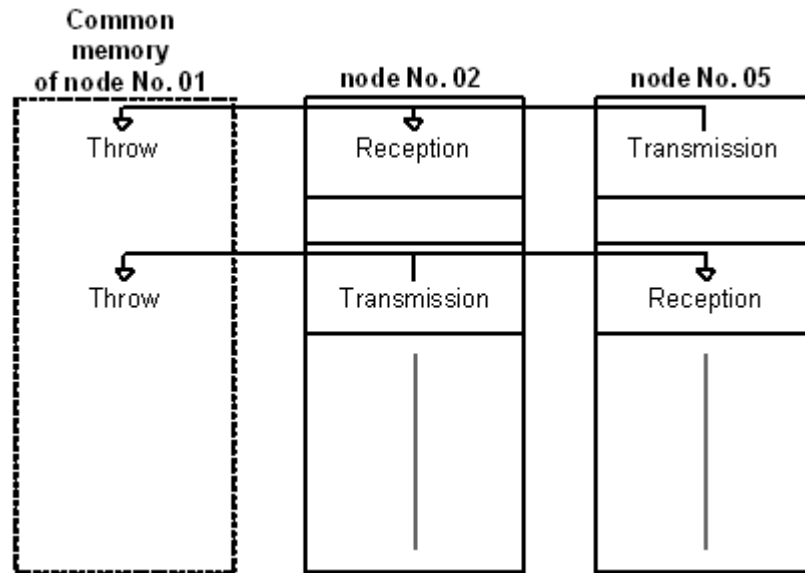

Area 1 and area 2

A node shall be assigned two data areas, area 1 and area 2, as the transmitting areas in its common memory.

A transmitting area is defined by the top address and size of the area.

Access to the area is made by word address. Area 1 consists of 0.5k word and area 2 consists of 8k words.

Assignment of Area 1 and Area 2

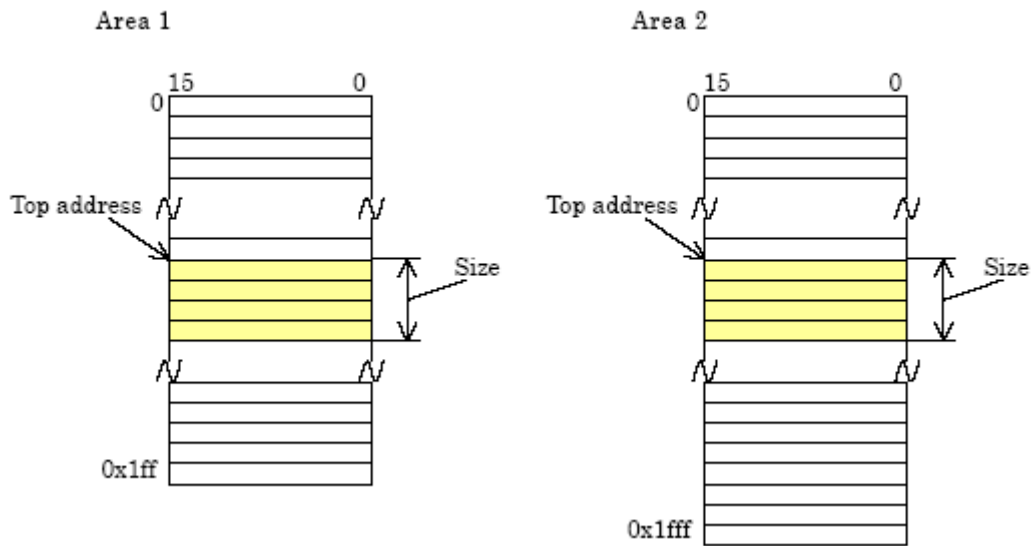

Common memory area size that one node should have

A node that is intended to perform cyclic transmission must have a common memory area size of 8.5k words.

A node that is not intended to perform cyclic transmission does not need to have any common memory area.

For more information about FL-net please refer the FL-net Protocol Specifications Version 1.0: MSTC / JOP-1012

3.2.2 Module Power Up

Main Logic Loop

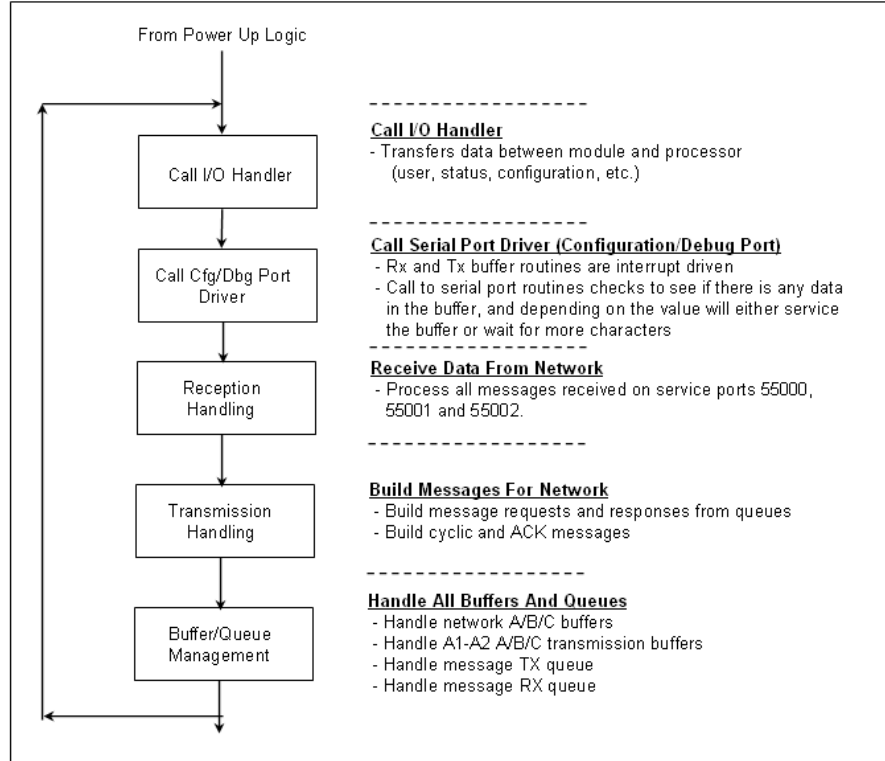

3.2.3 Backplane Data Transfer

MVI56-FLN Block Assignments Summary

In order to exchange data with the processor, the MVI56-FLN module supports the following block. The block range refers to the Block ID used to identify each block.

Input Data

Block Range	Descriptions
0 & -1	Status Data
1 to 3	Area 1 Data From Common Memory
4 to 35	Area 2 Data From Common Memory
1000 to 1004	Message Request ACK Blocks (future)
1100 to 1104	Message Response Blocks (future)
2000	Participation Table Response
9250	Log Data Block

Output Data

Block Range	Descriptions
0 & -1	Empty Data Blocks
1 to 3	Area 1 Data To Common Memory
4 to 35	Area 2 Data To Common Memory
1000 to 1004	Message Request Blocks (future)
2000	Participation Table Request
9250	Log Data Block Request
9998	Warm-boot control block
9999	Cold-boot control block

Read Block

Area 1 Input (Read) Data Block

Offset	Description	Length
0	Write Block ID Requested (1 to 3)	1
1 to 240	Area 1 data from field	240
241	Reserved	1
242	Reserved	1
243	Reserved	1
244	Reserved	1
245	Reserved	1
246	Reserved	1
247	Reserved	1
248	Reserved	1
249	Read Block ID (1 to 3)	1

Area 2 Input (Read) Data Block

Offset	Description	Length
0	Write Block ID Requested (4 to 35)	1
1 to 240	Area 2 data from field	240
241	Reserved	1
242	Reserved	1
243	Reserved	1
244	Reserved	1
245	Reserved	1
246	Reserved	1
247	Reserved	1
248	Reserved	1
249	Read Block ID (4 to 38)	1

Write Block

Empty Output (Write) Data Block

Offset	Description	Length
0	Write Block ID (-1 or 0)	1
1 to 240	Reserved	240
241	Reserved	1
242	Reserved	1
243	Reserved	1
244	Reserved	1
245	Reserved	1
246	Command Byte	1
247	Upper Layer Status for Module	1

Area 1 Output (Write) Data Block

Offset	Description	Length
0	Write Block ID (1 to 3)	1
1 to 240	Area 1 Data to field	240
241	Reserved	1
242	Reserved	1
243	Reserved	1
244	Reserved	1
245	Reserved	1
246	Command Byte	1
247	Upper Layer Status for Module	1

Area 2 Output (Write) Data Block

Offset	Description	Length
0	Write Block ID (4 to 38)	1
1 to 240	Area 1 Data to field	240
241	Reserved	1
242	Reserved	1
243	Reserved	1
244	Reserved	1
245	Reserved	1
246	Command Byte	1
247	Upper Layer Status for Module	1

Special Blocks

Participation Table Request (Write Block) Output Data

Offset	Description	Length
0	2000	1
1	Number of nodes to report (1 to 10)	1
2	Index of first node (0 to 255)	1
3 to 247	Spare	245

Participation Table Response (Read Block) Input Data

Offset	Description	Length
0	Write Block ID Requested	1
1	Number of nodes to reported (0 to 10)	1
2 to 21	Participation Data first node	20
22 to 41	Participation Data second node	20
42 to 61	Participation Data third node	20
62 to 81	Participation Data fourth node	20
82 to 101	Participation Data fifth node	20
102 to 121	Participation Data sixth node	20
122 to 141	Participation Data seventh node	20
142 to 161	Participation Data eighth node	20
162 to 181	Participation Data ninth node	20
182 to 201	Participation Data tenth node	20
202 to 248	Spare	47
249	2000	1

Participation Data Structure (20 words)

Offset	Description	Words
0	Node Number	1
1	Node Number (0 if not participating)	1
2	Token watchdog time	1
3	Allowable minimum frame interval	1
4	FL Link status	1
5	Upper layer status	1
6	Top Area 1	1
7	Size Area 1	1
8	Top Area 2	1
9	Size Area 2	1
10	Allowable refresh cycle time	1
11	Missed count	1
12 to 13	Rx Version sequence number	2
14 to 15	Rx Broadcast sequence number	2
16 to 17	Rx Peer-to-peer sequence number	2
18 to 19	Tx Peer-to-peer sequence number	2

Log Data Request (Write Block) Output Data

Offset	Description	Length
0	9250	1
1 to 247	Spare	247

Log Data Request (Read Block) Input Data

Offset	Description	Length
0	Write Block ID Requested	1
1	Spare	1
2 to 3	Socket Tx count	2
4 to 5	Socket Tx error count	2
6 to 7	Socket Rx count	2
8 to 9	Socket Rx error count	2
10 to 11	Tokens Tx	2
12 to 13	Cyclic Tx	2
14 to 15	Peer-to-peer message Tx	2
16 to 17	Broadcast message Tx	2
18 to 19	Tokens Rx	2
20 to 21	Cyclic Rx	2
22 to 23	Peer-to-peer message Rx	2
24 to 25	Broadcast message Rx	2
26 to 27	Cyclic Rx errors	2
28 to 29	Cyclic Rx address size errors	2
30 to 31	Cyclic Rx CBN errors	2
32 to 33	Cyclic Rx TBN errors	2
34 to 35	Cyclic Rx BSIZE errors	2
36 to 37	Message retrans	2
38 to 39	Message over retrans	2
40 to 41	Message Rx errors	2
42 to 43	Message Rx version sequence errors	2
44 to 45	Message sequence retrans errors	2
46 to 47	ACK errors	2
48 to 49	ACK version sequence errors	2
50 to 51	ACK sequence errors	2
52 to 53	ACK node number errors	2
54 to 55	ACK TCD errors	2
56 to 57	Token multiple errors	2
58 to 59	Token discards	2
60 to 61	Token reissued	2
62 to 63	Token holding timeouts	2
64 to 65	Token monitoring timeouts	2
66 to 67	Total service time (seconds)	2

Offset	Description	Length
68 to 69	Frames waiting	2
70 to 71	Number of nodes participating	2
72 to 73	Self exits	2
74 to 75	Exits by skipping	2
76 to 77	Exits of other nodes	2
78 to 79	Spare	2
80	Node holding token	1
81	Network allowable min frame interval	1
82	Network allowable refresh cycle time	1
83	Current measured refresh cycle time	1
84	Maximum refresh cycle time	1
85	Minimum refresh cycle time	1
86 to 248	Spare	163
249	9250	1

3.2.4 Data Flow between Module and Processor

The following discussion outlines the flow of data between the two pieces of hardware (ControlLogix processor and MVI56-FLN module) and other nodes on the TCP/IP network.

Module's Cyclic Input Data

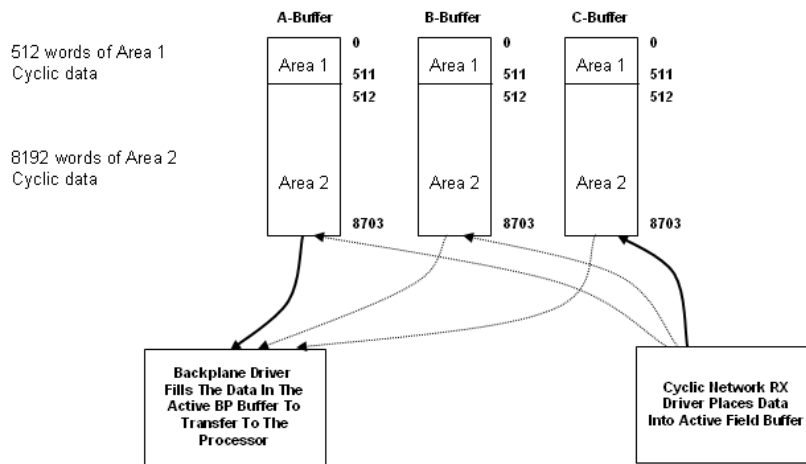

Module's Cyclic Output Data

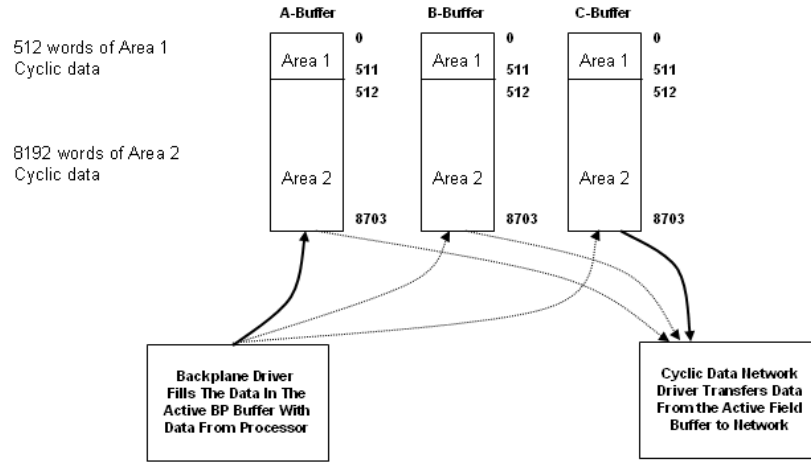

3.3 Implementation of FL-net

The following two classes are defined considering differences among necessities of FL-net transmission functions for various devices.

Class	Class Cyclic transmission		Message transmission	
	Sending	Receiving	Client function	Server function
1	Mandatory	Mandatory	Optional	Optional
2	Not applicable	Optional	Optional	Optional

Notes:

- 1 "Sending" of "cyclic transmission" indicates a function that the node allocates common memory and that it transmits data in the common memory of the own node to other nodes cyclically.
- 2 "Receiving" of "cyclic transmission" indicates a function that the system receives data from the common memory of other nodes cyclically.
- 3 The "client function" of "message transmission" indicates a function that the node transmits request messages and that it receives response messages.
- 4 The "server function" of "message transmission" indicates that the node processes request messages and that it returns response messages.

3.3.1 Information Tables

Types of management table

Node status management is divided into self-node management table, participating node management table, and network management table.

- 1 The self-node management table manages the settings of the self-node.
- 2 The participating node management table manages the information of the nodes of in-ring the network.
- 3 The network management table manages the common network information.

The MVI56-FLN module conforms to the mandatory items in the following tables.
 For more information refer to *Status Data* (page 109).

Table name	Information	Conforming level
Own-node management Table	Node number	<i>Mandatory</i>
	Area 1 data top address	Optional (Supported)
	Area 1 data size	Optional (Supported)
	Area 2 data top address	Optional (Supported)
	Area 2 data size	Optional (Supported)
	Upper layer status	<i>Mandatory</i>
	Token watchdog time	Optional (Supported)
	Allowable minimum frame interval time	Optional (Supported)
	Vendor code	Optional
	Manufacturer model name	Optional (Supported: Vendor Model)
	Node name	Optional (Supported)
	Protocol type	Optional (Supported)
	FA link status	<i>Mandatory</i> (Supported)
	Own-node status	<i>Mandatory</i> (Supported)
Participating node management table	Node number	<i>Mandatory</i> (Supported)
	Upper layer status	<i>Mandatory</i>
	Area 1 data top address	<i>Mandatory</i>
	Area 1 data size	<i>Mandatory</i>
	Area 2 data top address	<i>Mandatory</i>
	Area 2 data size	<i>Mandatory</i>
	Allowable refresh cycle time	Optional (Supported)
	Token monitoring time	Optional (Not Supported)
Network management table	Allowable minimum frame interval time	Optional (Supported)
	FA link status	<i>Mandatory</i>
	Token holding node number	Optional (Supported)
	Allowable refresh cycle time	Optional (Supported)
	Refresh cycle measurement time (Current value)	<i>Mandatory</i>
	Refresh cycle measurement time (Maximum value)	Optional (Supported)
Refresh cycle measurement time (Minimum value)	Optional (Supported)	

Own node management table

This table manages the data on the settings of the self-node.

- 1 The table is used to network parameter read and participation request frames.
- 2 Management data is set from the FA link protocol upper layer at the node startup time.
- 3 The node names and the top addresses and size of the transmitting area in the common memory can be set from the network.

Own node management table

Table name	Size	Description
(1) Node number	(1 byte)	1 to 254
(2) Area 1 data top address in common memory	(2 bytes)	Word address (0 to 0x1ff)
(3) Area 1 data size in common memory	(2 bytes)	Size (0 to 0x1ff)
(4) Area 2 data top address in common memory	(2 bytes)	Word address (0 to 0x1fff)
(5) Area 2 data size in common memory	(2 bytes)	Size (0 to 0x1fff)
(6) Upper layer status	(2 bytes)	RUN / STOP / ALARM / WARNING / NORMAL See status block (page 109) for additional information
(7) Token watchdog time	(1 byte)	1 to 255 (1 ms. Units)
(8) Allowable minimum frame interval	(1 byte)	10 to 50 (in units of 100ms.)
(9) Vender code	(10 byte)	Vender code
(10) Manufacture Model name	(10 bytes)	Manufacture Model name , device name
(11) Node name (equipment name)	(10 bytes)	Node name set by user
(12) Protocol version	(1 byte)	0x80 (fixed)
(13) FA link status	(1 byte)	in-ring / out-ring, etc.
(14) Self-node status	(1 byte)	Node number conflict detection, etc.

Participating Node Management Table

The node status of each node joining in the network is monitored by the management table held by each node. Regarding the nodes joining the network, this table handles the data to be managed for each node.

- 1 At a start, participating node management table and the network management table is created in accordance with the received token frame.
- 2 Upon receipt of each token frame, each node updates the participating node management table.
- 3 Upon receipt of the participation request frame for new joining, the joining node management table is updated.
- 4 When non-reception of a token frame of each node or a timeout is detected 3 times running, the corresponding node is deleted from the table.

Table name	Size	Description
(1) Node number	(1 byte)	1 to 254
(2) Upper layer status	(2 bytes)	RUN / STOP / ALARM / WARNING / NORMAL See status block for additional information
(3) Area 1 data top address in common memory	(2 bytes)	Word address (0 to 0x1ff)
(4) Area 1 data size in common memory	(2 bytes)	Size (0 to 0x1ff)
(5) Area 2 data top address in common memory	(2 bytes)	Word address (0 to 0x1fff)
(6) Area 2 data size in common memory	(2 bytes)	Size (0 to 0x1fff)
(7) Allowable refresh cycle time	(2 bytes)	1 ms. (unit)
(8) Token watchdog time	(1 byte)	1 to 255 (1 ms. Units)
(9) Allowable minimum frame interval	(1 byte)	1 to 50 (in units of 100ms.)
(10) Link status	(1 byte)	in-ring / out-ring information, etc.

Network management table

This table manages the parameters related to the network status.

Table name	Size	Description
(1) Token holding node number	(1 byte)	Node currently holding a token
(2) Allowable minimum frame interval	(1 byte)	1 to 50 (in units of 100ms.)
(3) Allowable refresh cycle time	(2 byte)	1 ms. (unit)
(4) Refresh cycle measurement time (present value)	(2 byte)	0 to 65535 (in 1 ms(unit)
(5) Refresh cycle measurement time (maximum value)	(2 byte)	1 ms. (unit)
(6) Refresh cycle measurement value (minimum value)	(2 byte)	1 ms. (unit)

Upper Layer Status Read Definition

The node status is divided into two types: FA link protocol upper layer status (referred to as the upper layer status) and FA link protocol status (referred to as the FA link status).

Upper layer status

The upper layer status is divided into upper layer operation information and upper layer error information.

Upper layer operation information

- RUN: Indicates that the upper layer program is running.
- STOP: Indicates that the upper layer program is at a stop.

Upper layer error information

- **NORMAL:** Indicates that the upper layer is normal and both cyclic data and message data are guaranteed.
- **WARNING:** Indicates that there occurs an error that permits continuing operation in the upper layer but both cyclic data and message data are guaranteed.
- **ALARM:** Indicates that there occurs an error that does not permit continuing operation in the upper layer and both cyclic data and message data are not guaranteed.

Contents of error in the upper layer: Indicates the contents of an error in the upper layer program.

The upper layer program means those that have an interface with the FA link protocol upper layer, which for the MVI-FLN module is the ControlLogix processor.

Upper Layer Status Table

Operation Information

Error information	Run	Stop
NORMAL	The upper layer program is running and both cyclic data and message data are guaranteed.	The upper layer program is at a stop but both cyclic data and message data are guaranteed.
WARNING	The upper layer program is running with an error but both cyclic data and message data are guaranteed.	The upper layer program is at a stop with an error but both cyclic data and message data are guaranteed.
ALARM	Both cyclic data and message data are not guaranteed.	Both cyclic data and message data are not guaranteed.

The Upper Layer Status word is structured as follows:

Upper Layer Status Word

Bit	Description	Value
0 to 11	Error Code (User Defined)	0x0001
12	reserved	0x1000
13	1=Warning, 0=No Warning	0x2000
14	1=Alarm, 0=No Alarm	0x4000
15	1=Run, 0=Stop	0x8000

The output blocks that transfer Area 1 and Area 2 data from the ControlLogix to the MVI56-FLN module (blocks 1 to 38) update the Upper Layer Status through word offset 247. The sample ladder logic uses the FLNETMODULE.CONTROL.UpperLayerStatus controller tag to update the upper layer status.

For example, to set a warning condition, set this controller tag as shown in the following illustration:



You can monitor the Upper Layer Status from the Display Own Node Status command in the Configuration/Debug menu.

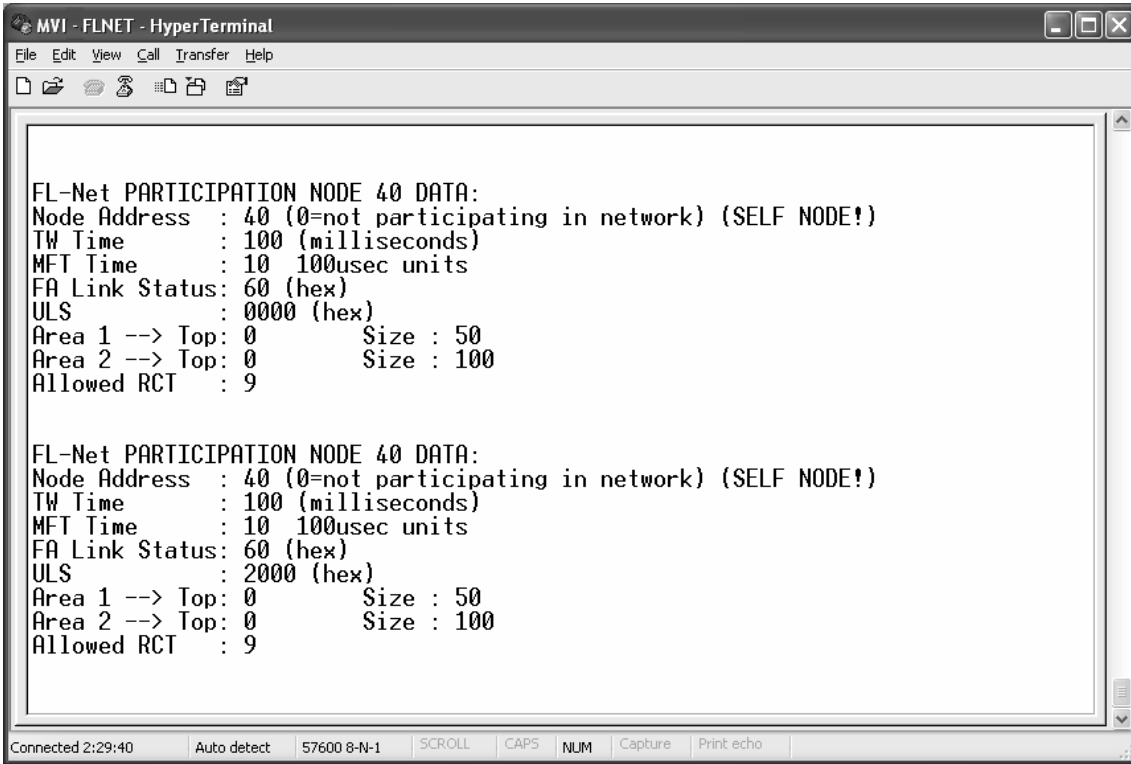

FA link status

The information on link status is divided into two types: information shared on the network and information to be managed by each node.

In-ring and out-ring of each node are managed in units of node. All information except the above is shared on the network.

Message	Description
Address overlapping detection	Indicates that there is any overlapping setting in the common memory of a node connected to the network.
Common memory setting completion	Indicates that the setting in the common area of a node is completed.
Common memory data validity	Indicates that cyclic data is effective.
Upper layer operation signal error	Indicates that updating of the existence signal of the upper layer cannot be recognized.
Node in-ring / out-ring	Indicates the information managed to see whether each node joins the network or secedes from it.

The MVI56-FLN module allows the processor to dynamically set the module to out-ring and then again to in-ring state. The output blocks that transfer Area 1 and Area 2 data from the ControlLogix to the MVI56-FLN module (blocks 1 to 38) updates word offset 246 which is reserved for this purpose (in-ring and out-ring command).

The sample ladder logic uses the *FLNETMODULE.CONTROL.In_Out_RingCommand* controller tag to update this register. Setting a value of 0 will not interfere on the module regular functionality (it will go in-ring once finds other nodes in the network as defined in the protocol specification)

+ FLNETMODULE.CONTROL.In_Out_RingCommand	0	Decimal	INT
--	---	---------	-----

In order to monitor the in-ring and out-ring state the user can refer to the FA Link status which according to the protocol specification is defined as follows:

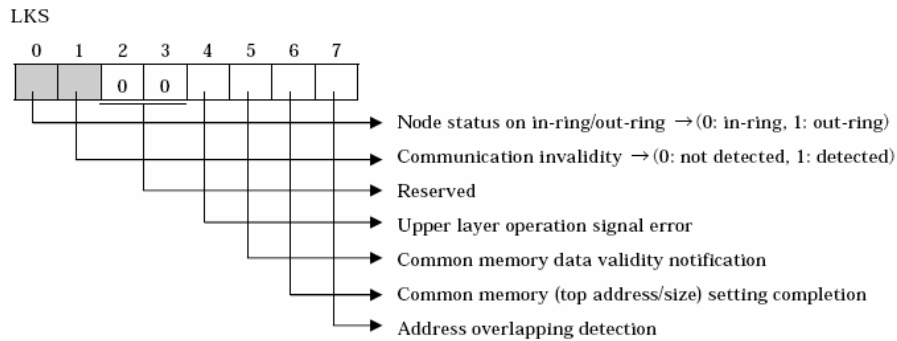

Figure 4 LKS Data

You can monitor the FA Link Status through the *FLNETSTATUS.Own_node.FA_link_status*. For this example bit 0 is currently set as 0 (MVI56-FLN is in-ring)

+ FLNETSTATUS.Own_node.FA_link_status	2#0110_0000	Binary	SINT
---------------------------------------	-------------	--------	------

Setting a value of 1 to *FLNETMODULE.CONTROL.In_Out_RingCommand* controller tag will set the MVI56-FLN module as out-ring:

+ FLNETMODULE.CONTROL.In_Out_RingCommand	1	Decimal	INT
--	---	---------	-----

- **Version 1.04 or higher:** The out-ring state can be checked by the FA Link status which now indicates that all bits are set to 0 (out-ring).
- **Older Versions :** The out-ring state can be checked by the FA Link status which now indicates that bit 0 is set to 1 (out-ring).

+ FLNETSTATUS.Own_node.FA_link_status	2#0000_0000	Binary	SINT
---------------------------------------	-------------	--------	------

You can observe that the LER/LE LED will be asserted to indicate that the module was set out-ring.

Setting a value of 2 to *FLNETMODULE.CONTROL.In_Out_RingCommand* controller tag will set the MVI56-FLN module again to in-ring:

+ FLNETMODULE.CONTROL.In_Out_RingCommand	2	Decimal	INT
--	---	---------	-----

- **Version 1.04 or higher:** The in-ring state can be checked by the FA Link status which now indicates that bit 0 is set to 1 (in-ring)
- **Older Versions:** The in-ring state can be checked by the FA Link status which now indicates that bit 0 is set to 0 (in-ring)

```
+ FLNETSTATUS.Dwn_node,FA_link_status      2#0110_0001      Binary  SINT
```

Self-node status

This is the information on self-node status to be given to the upper layer.

Message	Description
Self-node number conflict	Indicates the management information on node number conflicted to see whether any node having the same node number as the self-node setting exists on the network or not.
Token monitoring time error	Indicates the error notice information that transmit processing has not been completed within the token monitoring time set in the self-node.
Receive waiting status	Indicates that no frame has been received at network initialization, being a frame receive waiting status.
Initialize error	Indicates an error is found in an initial setting or resetting parameter.

Timer Types

Message	Description
Token monitoring time	Set from the upper layer (in units of 1 ms).
Allowable refresh cycle time	Calculated from the refresh time only for cyclic transmission.
Refresh cycle measurement time	Measurement value in a circulation of a token: Present value. The maximum value and the minimum value from the start time are held. (in units of 1 ms).
Allowable minimum frame interval time	Set from the upper layer. The maximum value on the network is effective. (in units of 100 microseconds).
Joining token detection time	Fixed value (3 seconds)
Participation request frame transmission waiting time	Fixed value (self-node number × 4 ms)
Three-circulation waiting time	Fixed value (3 seconds)
Token holding timeout time	Within this time after receipt of a token directed to the self-node, a token must be transmitted to the next node.
Trigger frame transmission waiting time	Fixed value ((self-node number mod 8) × 4 ms)

3.3.2 Lower Layer Protocol

Address Setting

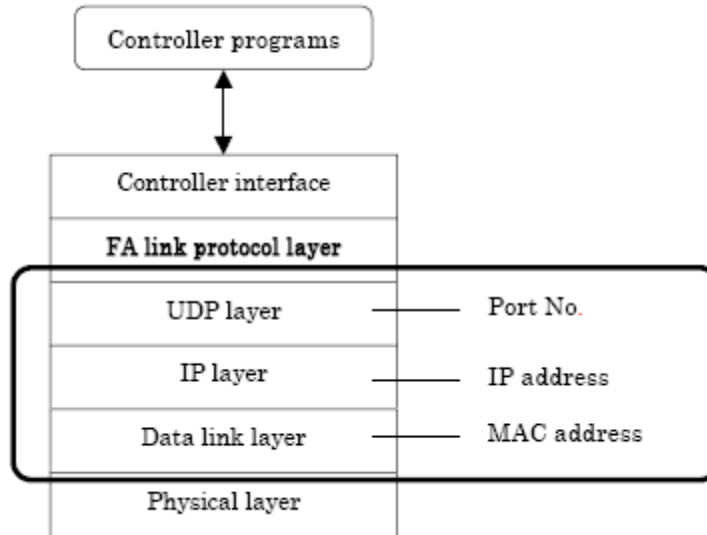

IP address

The IP address is set from the upper layer of the FA link protocol.

The sub-network mask is also set from the upper layer of the FA link protocol.

The default value of the transmission source is specified as 192.168.250.N (N = node No.: 1 to 125).

The default value of the transmission destination is specified as 192.168.250.255.

Remarks: For the IP address, it is recommended that class C is used and that the lower host address is matched with the FA link protocol node No

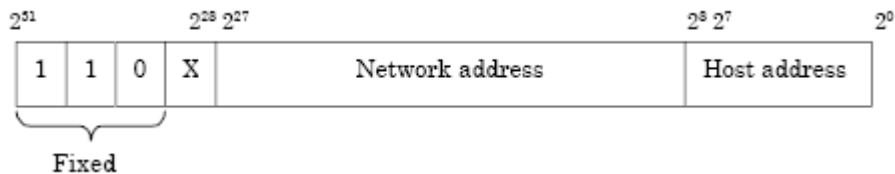

MAC address

As the MAC address, the default set in the unit is used.

Port number

For reception

- Cyclic transmission port number (for system: 55000 fixed)
- Message transmission port number (for system: 55001 fixed)
- Participation request frame port number (for system: 55002 fixed)
For transmission
- Transmission port number (for system: 55003 fixed)

3.4 FL-net Node Configuration Parameters

3.4.1 Node Number

Node number is set by software configuration file (FLNET.CFG) using HyperTerminal. As the initial value, a node number is set from the FA link protocol upper layer. Without a node number, the node is inoperable. When a node number conflict is detected before joining the network, it does not transmit any frame. The range of the node address is 1 to 254.

3.4.2 Top address and data size of common memory transmitting area

These parameters can be set from the upper layer or by a network parameter write message.

When nodes receive a network parameter write message for setting these parameters, the node secedes from the network and rejoins this network in the halfway participation status.

Unless they are set from the upper layer, the node is regarded as having no transmitting area. At this time, however, a token is exchanged.

The range of top address and size of areas 1 and 2 of common memory are as follows:

- 1 Top address of common memory area 1: (0...16#1FF)
- 2 Data size of common memory area 1: (0...16#200)
- 3 Top address of common memory area 2: (0...16#1FFF)
- 4 Data size of common memory area 2: (0...16#2000)

3.4.3 Node name (equipment name)

This can be set from the upper layer or by a network parameter write message.

When it is set from the network by using message transmission, the node does not secede from the network if only the node name is changed, continuing communication. The node name is set in ASCII character set up to 10 characters.

3.4.4 Token monitoring time

This time value is peculiar to each node. This time value is set from the FA link protocol upper layer as the initial value. If this value is not set, the node is inoperable.

The token monitoring time is notified to all nodes as information on the frame header. Each node uses the value on the frame from each node as a value of the monitoring time until token holding node releasing the token.

The watchdog time is set as 1 to 255 in the unit of 1 millisecond.

3.4.5 Allowable minimum frame interval

This interval value is a peculiar to each node. This value is set from the FA link protocol upper layer as the initial value. If this value is not set, the node is inoperable.

The allowable minimum frame interval is set to 0 to 50 (in units of 100 milliseconds).

The allowable minimum frame interval means the following 2 contents:

- Time from receiving a token directed to the node until transmitting any frame from the node.
- Time of transmitting frame interval. (From the end of the previous frame until the beginning of the next frame) The allowable minimum frame interval of each node is notified to all nodes as information on the frame header. Each node obtains the maximum value from it and recognizes it as the allowable minimum frame interval to use.

Important Note: For this module to operate correctly on an FL-net network, this parameter must be set to a value of 20 or more for all nodes on the network. If nodes on the network have values less than 20 for this parameter, the module may not be able to join the network.

3.4.6 Allowable refresh cycle time

Each node always monitors the message frames in the network in the period from receipt of a token until receipt of the next token to the node. If there is no message frame in the network in this 1 cycle, this cycle time × 1.2 is specified as the allowable refresh cycle time.

When the network is started, the allowable refresh cycle time is set to "0". When a token directed to the node is received 3 times at the start-up, a refresh cycle measurement will be started. Accordingly, the network does not perform message transmission before a token is circulated once.

A node that joins in the halfway participation status, starts measuring the refresh cycle time after the third token reception to the node.

The allowable refresh cycle time is dynamically determined depending on the number of nodes joining the network.

3.4.7 Memory Resources

The module provides 8700 words for shared Area1 and Area2 common memory.

3.5 FL-net Protocol and network

3.5.1 Understanding the Basics of FL-net

The MVI56-FLN module is equipped to use with 10Base-T FL-net (Version 2.00) Systems.

The basic configuration of a 10Base-T FL-net System consists of one hub to which nodes are attached in star form through twisted-pair cable.

Number of Connectable Nodes and Node Numbers

Up to 254 nodes can be connected to an FL-net network. Each node is assigned a node number from 1 to 254.

Node number	Applications
1 to 249	Used for standard FL-net (Version 2.00) devices.
250 to 254	Used for FL-net (Version 2.00) maintenance purposes.
255	Reserved for internal system use. (used for broadcasting not available to users)
0	Reserved for internal system use.

Assignment of common memory

- Two data areas "area1 and area2" can be assigned for a node.
- Area 1 has 512w and area 2 has 8192w. (1w=16bits)
- Both areas can be assigned at any word-size within the maximum.
- Both areas are defined by the top address and size of the area.

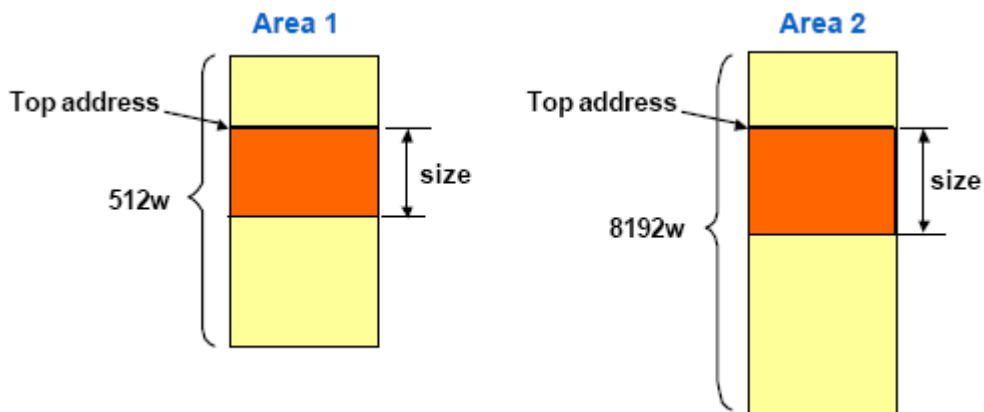

Data Communications

FL-net supports data communications by cyclic transmission and message transmission.

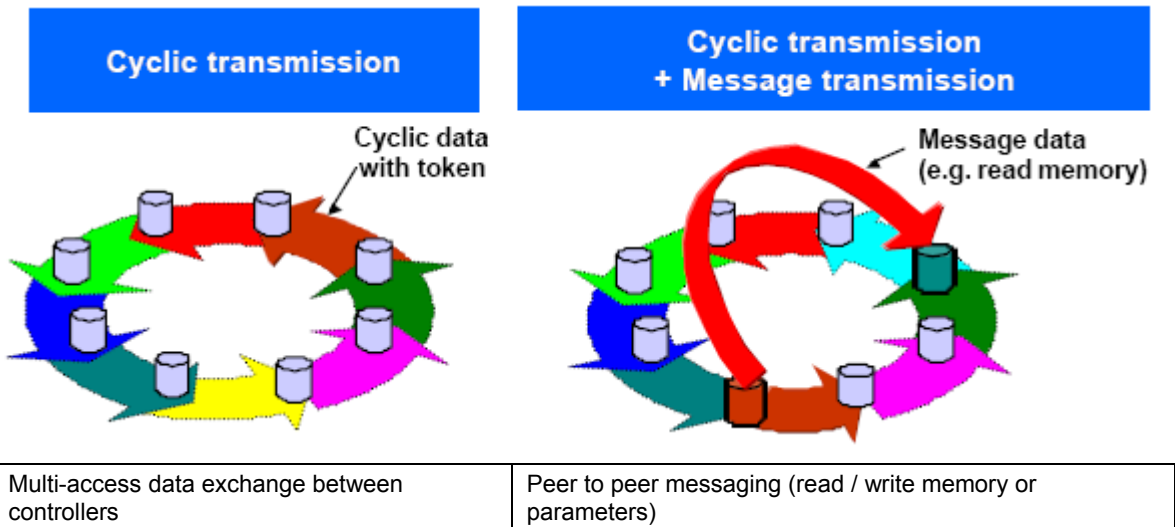

Transmission Cycle

With cyclic communications, the Common Memory is refreshed on a fixed cycle time. Message communications are controlled so that the Common Memory refresh time does not exceed the allowable refresh cycle time.

Each node constantly monitors the message communications frames that travel through the network from the time it receives one local-node-directed token until it receives the next local-node-directed token. When no message communications frame travels through the network in a single cycle, 120% of the cycle time value becomes the allowable refresh cycle time. In this way the allowable refresh cycle time is actively determined according to the number of nodes in the network.

Common memory is divided by each node not to be overlapped.

- Share the same data in a system by each node's data broadcasting.
- Data on the common memory is refreshed cyclically.
- User can use the common memory as global area in the node.

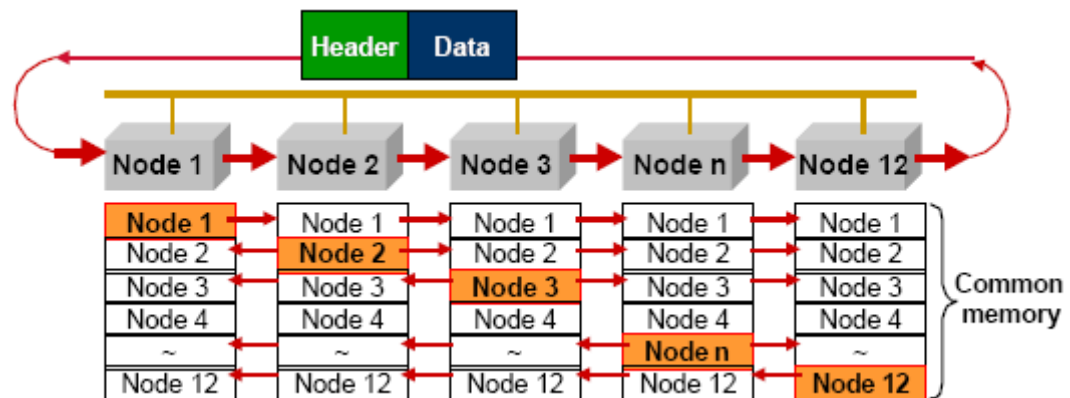

Multiple frames of cyclic data

- Multiple frames may be used if the transmitting area size exceeds the frame data size that is 1024 byte.
- A node receiving multiple frames, the node shall update the area after receiving all frames from sending node.

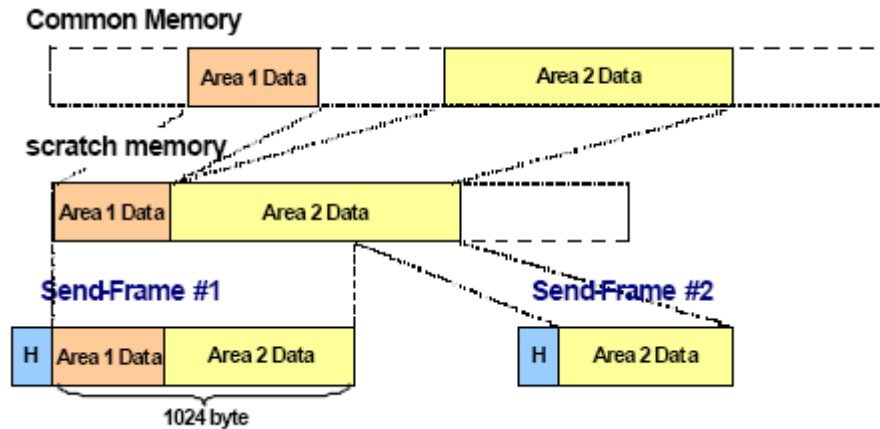

3.5.2 Data Frame ID of FL-net

When review the network with an analyzer such as Ethereal the user can examine the protocol frames and use the table below to determine the transaction type.

Data Frame ID: Transaction Code

Transaction Code	Application
0 to 59999	Transparent mode message frame
60000 to 64999	Reserved
65000	Cyclic frame (with token)
65001	Cyclic frame (without token)
65002	Participation request frame
65003	Byte block read frame (request)
65004	Byte block write frame (request)
65005	Word block read frame (request)
65006	Word block write frame (request)
65007	Network parameter read frame (request)
65008	Network parameter write frame (request)
65009	Stop command frame (request)
65010	Start command frame (request)
65011	Profile read frame (request)
65012	Trigger frame
65013	Log data read frame (request)
65014	Log data clear frame (request)

Transaction Code	Application
65015	Echo back message frame (request)
65016 to 65202	Reserved (for future expansion)
65203	Byte block read frame (response)
65204	Byte block write frame (response)
65205	Word block read frame (response)
65206	Word block write frame (response)
65207	Network parameter read frame (response)
65208	Network parameter write frame (response)
65209	Stop command frame (response)
65210	Start command (response)
65211	Profile read frame (response)
65212	Reserved
65213	Log data read frame (response)
65214	Log data clear frame (response)
65215	Echo back message frame (response)
65216 to 65399	Reserved (for future expansion)
65400 to 65535	Reserved

3.5.3 Message Transmissions

- A token holding node can send up to one message frame.
- 1:1 transmission and 1:N transmission are provided.
- Message acknowledges is available for 1:1 transmission.

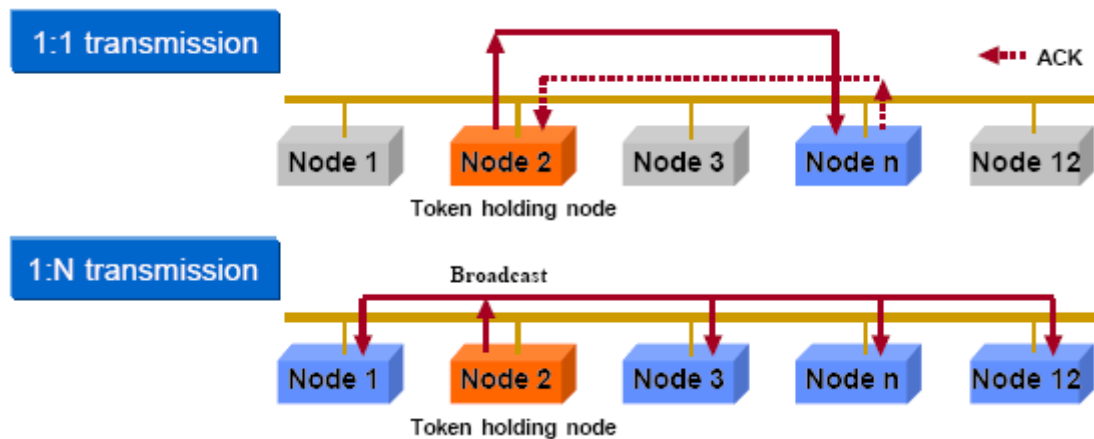

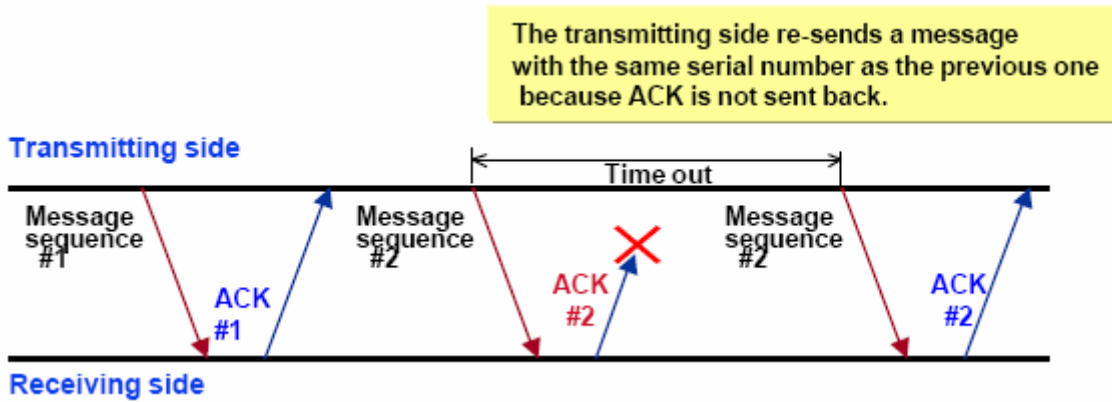

Type of message	ACK response	Re-send	Sequence No. control
1:1 message transmission	Yes	Yes	Yes
1:N message transmission	No	No	Yes

Message Transmission Services

Type of message service	Remarks
Read byte block data	Not supported
Write byte block data	Not supported
Read word block data	Not supported
Write word block data	Not supported
Read network parameter	Supported
Write network parameter	Not supported
Start operation	Not supported
Stop operation	Not supported
Read profile	Supported
Read log data	Supported
Clear log data	Supported
Transparent mode message	Not Supported
Echo back message	Supported

3.5.4 Message Transmission Function

Message transmission is a function that supports non-cyclic data exchange between nodes. *The MVI56-FLN module does not support the optional messaging functions except in response to Log Data request messages as follow:*

Log data read: Function reads the log data on a specified node.

- (Request) No data division.
- (Normal response) 512 bytes
- (Error response) The data division includes an error code.

Log data clear: Function clears the log related to a specified node.

- (Request) No data division.
- (Normal response) No data division.
- (Error response) The data division includes an error code.

Items provided for "Log Data Read" service

Major items	Minor items	Implemented (Y) or not(N)
Transmission / reception	Total number of transmission at socket unit *	Y
	Total number of transmission errors at socket unit *	Y
	Number of Ethernet transmission errors	N
	Total number of receptions *	Y
	Total number of reception errors *	Y
Frame types	Number of Ethernet reception errors	N
	Number of tokens transmitted	Y
	Number of cyclic frames transmitted	Y
	Number of peer-to-peer messages transmissions	Y
	Number of broadcast messages transmissions	Y
	Number of tokens received	Y
Cyclic transmission	Number of cyclic frames received	Y
	Number of peer-to-peer messages received	Y
	Number of broadcast messages received	Y
	Number of cyclic reception errors *	Y
	Number of cyclic address size errors	Y
	Number of cyclic CBN errors	Y
Message transmission	Number of cyclic TBN errors	Y
	Number of cyclic BSIZE errors	Y
	Number of message retransmissions *	Y
	Number of message over-retransmissions *	Y
	Number of message reception errors *	Y
	Number of message version-of-sequence number errors	Y
	Number of message sequence number retransmissions recognized	Y
ACK-related	Number of ACK errors *	Y
	Number of ACK version-of-sequence number errors	Y
	Number of ACK sequence number errors	Y
	Number of ACK node number errors	Y
	Number of ACK TCD errors	Y
Token-related	Number of token multiplications recognized *	Y
	Number of tokens discarded *	Y
	Number of tokens re-issued *	Y
	Number of token holding timeouts	Y
	Number of token monitoring timeouts	Y

Major items	Minor items	Implemented (Y) or not(N)
Total service time	Number of frame waiting states *	Y
	Number of participations *	Y
	Number of self-exits *	Y
	Number of exits by skipping *	Y
Status 1	Number of exits of other nodes recognized *	Y
Status 2	List of participation recognized nodes	Y
Vendor definable area	Self exits	Y
	Exits by skipping	Y
	Exits of other nodes	Y
	Spare	Y
	Node holding token	Y
	Network allowable min frame interval	Y
	Network allowable refresh cycle time	Y
	Current measured refresh cycle time	Y
	Maximum refresh cycle time	Y
Minimum refresh cycle time	Y	

3.5.5 Data volume and number of frames

The frame structure for cyclic transmission depends on the data volume consisting of area 1 and area 2.

- 1 When the data volume is 1024 bytes or less: This data is transmitted by one frame.

Figure when the transit data volume is 1024 bytes or less

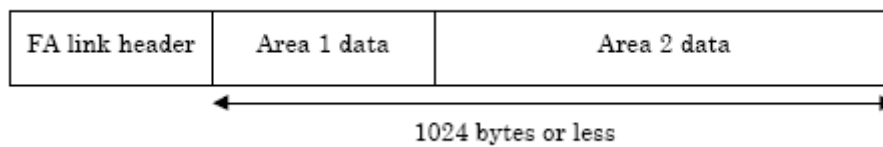

- 2 When the data volume exceeds 1024 bytes: This data is transmitted by 2 frames of more in divided form.

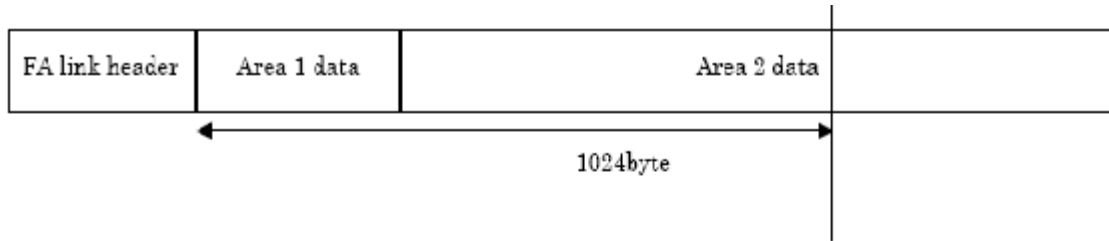

(a) 1st transmit data



(b) 2nd and subsequent transmit data

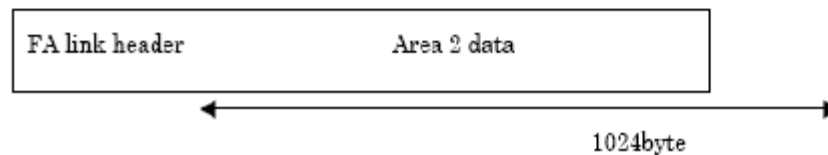

Figure when the transmit data volume exceeds 1024 bytes
Two or more divided frames are continuously sent in the token held state.

3.5.6 Network Management

- Node addition can be done while FL-net system is running.
- System is running even if any node will be failure.
- Every node knows state all other nodes.
Every node manages In-ring and Out-ring of nodes
- One token is circulated among all nodes in the FL-net and
Token is monitored by the time of each node.
If a node does not send the token, next node will reissue it in a fixed time.
- Out-ring management
If a node does not send the token, every node will recognize the node failure.
- In-ring management
New node sends a participation request frame and every node monitors it.
- Node state management
Network status and upper layer status are attached in the cyclic frame.

3.5.7 Masterless Transmission Management

Token

Basically, while a node holds a token, the node can transmit data.

In the following two cases, however, transmission is enabled without a token. That is, one is reissue of token due to a token monitoring time is up and the other is a transmission of participation request frame when the node has not joined in the network.

- 1 In the FL-net, a single token is circulated among nodes. A node receiving a token, this node will hold the transmission right until it releases the token to the next node.
- 2 The token is circulated among all the nodes joining in the FL-net.
- 3 The token can be transmitted together with cyclic data.
- 4 The token can also be circulated without any data.
- 5 The token is monitored by the timer of each node. If the token is not sent in the network for a fixed time, another token will be reissued automatically.
- 6 If there are two tokens in the network, they are unified into one.

Token flow

Only one token exists in the network.

A frame including a token (token frame) is provided with a node number of destination and node number of token transmitting side. Each node becomes a token holding node when a match is found with the destination node number of the received token frame.

The token rotation order is determined in the ascending order of node number. The node with the largest node number releases a token to the node with the smallest node number.

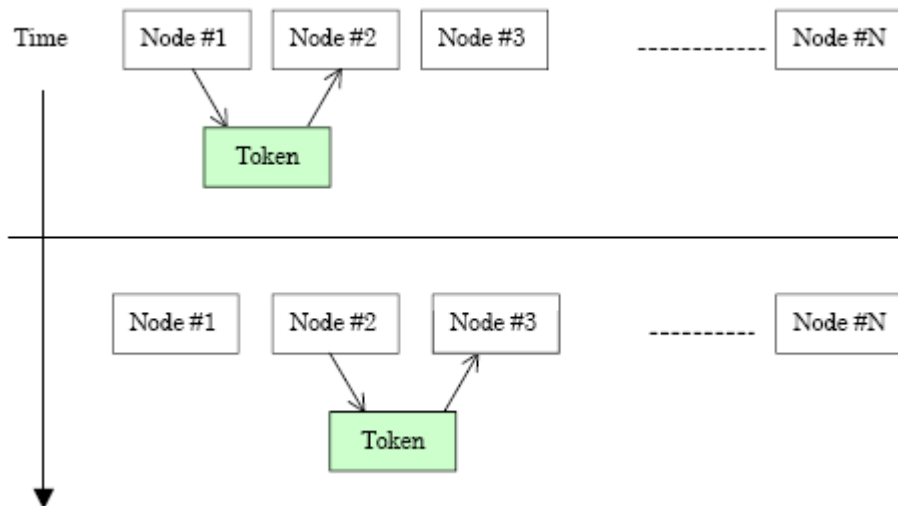

Token and frames

As patterns of the frames to be sent with a token, the following 6 types are available.

- 1 When there is no cyclic data to be sent: Only a token is transmitted.
- 2 When there is only cyclic data: a token is transmitted together with cyclic frame.
- 3 When there is only cyclic data and this cyclic data is sent in divided form: Only the cyclic frames are transmitted and a token is attached to the last cyclic frame.
- 4 When there is only message data: The message frame is transmitted and then a token is transmitted.
- 5 When there are cyclic data and message data: The message frame is transmitted and then the cyclic frame is transmitted together with a token.
- 6 When there are cyclic data and message data and the cyclic data is sent in divided form: The message frame is transmitted and then only the cyclic frames are transmitted and a token is attached to the last frame.

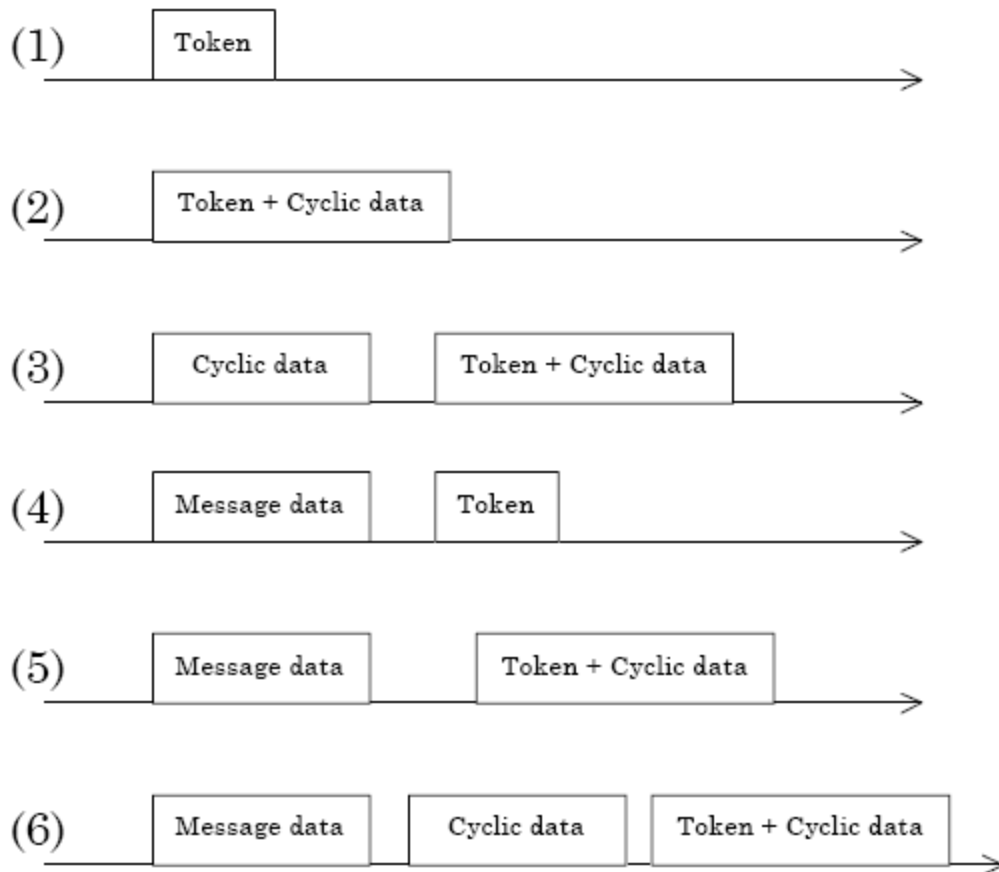

3.5.8 FA link protocol

In-ring and out-ring management

In-ring and out-ring of other nodes

At network initialization, each node monitors the line until the joining token detection time is up. If the node monitors token flow, the node considers it as a halfway participation state and performs the processing of (1) below. In the other case, if the node does not monitor any token, the node considers itself as a network start-up state and performs the processing of (2) below.

1 When monitoring a token flow (halfway participation state)

When monitoring a token flow within the joining token detection time, it is recognized that a link is already established.

At this time, the node waits for transmission of a participation request frame until the token is circulated 3 times. In this period, a node number conflict check and an address overlapping check of common memory are made by the received frames and the participating node management table is updated. If any address overlapping is detected, the node set the common memory top address and data size of areas 1 and 2 to 0 and shall not transmit cyclic data. At the same time, the node sets the address overlapping flag, and resets the common memory data validity flag.

When no error is found in node number, the node will send out a participation request frame after the participation request frame transmission waiting time is up. The participation request frame is transmitted regardless of token holding.

A node that has recognized a node number conflict does not transmit a participation request frame and does not join the network. The node number conflict error shall be notified to the upper layer.

When a token for the self-node is not received after the third circulation though the node joined the network by the participation request frame, this node transmits a participation request frame again. Token monitoring is performed for the joining token detection time. When a token is received, the node is put into a halfway participation status. When no token is received, it is put into a network startup status that will be described later.

2 When receiving no token (network startup status)

When no token is monitored during the joining token detection time, the node transmits a trigger frame after the remainder of $(\text{node number} / 8) \times 4$ milliseconds. If a trigger frame is received before the node transmits its trigger frame, the node shall transmit no trigger frame.

When the participation request frame transmission waiting time (node number \times 4 milliseconds) is up after a first trigger frame reception, each node transmits its participation request frame.

During the participation request frame reception waiting time (1200 milliseconds) after a first trigger frame reception, a conflict check of node number and an address overlapping check are made and the participating node management table is updated, thus each node shall wait for all nodes to transmit participation request frames.

A node that recognized address overlapping by the participation request frame reception from other nodes sets the common memory top address and common memory size of areas 1 and 2 to 0 and does not transmit cyclic data. At the same time, the node set the address overlapping and reset the common memory data validity flag.

The node having the smallest node number transmits a token first according to the participating node management table after the participation request frame reception waiting time is up.

A node that recognized conflict of node number does not transmit and receive data at all. A joining error in the network shall be notified to the upper layer.

A conflict of node number / address overlapping check are made when the node does not yet join the network. At the initial startup status, a conflict of node number / address overlapping check are made for both nodes that transmitted a participation request frame and nodes that did not transmit it. If overlapping is detected, the corresponding processing is performed.

When a node does not receive even one frame during the participation request frame reception waiting time, the node executes the start up sequence from monitoring the token for the joining token detection time. If the existence of other nodes is not recognized in the period from transmission of the third participation request frame until the participation request frame reception waiting time is up, the node sets a frame waiting flag. The node continues to resend a participation request frame until the network is established.

In case other nodes have fallen off and only one node remains during token circulation with the result that the node waits for a trigger frame or a token frame, the above is also applicable.

3.6 Error and Status Data

3.6.1 Status Data

Status Input (Read) Data Block

Offset	Description	Length
0	Write Block ID Requested (0 &-1)	1
1	FA_link status & Own status	1
2	Number of Nodes Active	1
3 to 18	Participation List	16
19 to 34	Nodes With Active Data	16
35	Token Node & MFT	1
36	Allowable refresh cycle time	1
37	Current refresh cycle time	1
38	Maximum refresh cycle time	1
39	Minimum refresh cycle time	1
40	Frames waiting to send	1
41	Node Number & protocol	1
42	FL-Status & Own Status	1

Offset	Description	Length
43	Top Area 1	1
44	Size Area 1	1
45	Top Area 2	1
46	Size Area 2	1
47	Upper Layer Status	1
48	Watchdog Timeout & MFT	1
49 to 53	Vendor Code (10 bytes)	5
54 to 58	Vendor Model (10 bytes)	5
59 to 63	Node Name (10 bytes)	5
64	Network Token Node & MFT	1
65	Network Allowable refresh cycle time	1
66	Network current refresh cycle time	1
67	Network maximum refresh cycle time	1
68	Network minimum refresh cycle time	1
69 to 99	Reserved for future use	31
100	Program scan counter	1
101 to 102	Product Code	2
103 to 104	Revision	2
105 to 106	Operating system revision	2
107 to 108	Run number	2
109	Block read count	1
110	Block write count	1
111	Block parse count	1
112	Block error count	1
113 to 248	Reserved for future use	136
249	Read Block ID (-1 or 0)	1

3.7 FL-net Device Profile for MVI56-FLN Module

3.7.1 Text Notation of Profile

Name of Parameter	Characters used [Printable String type], (length), (characters)	Data type [Type]	Text Notation (Length), (content)
Version of device profile common specification	6, "COMVER"	INTEGER	1, 1
System parameter ID	2, "ID"	Printable String	7, "SYSPARA"
System parameter revision number	3, "REV"	INTEGER	1, 0
System parameter revision date	7, "REVDATE"	[INTEGER], 2, (0001 to 9999), [INTEGER], 1, (01 to 12), [INTEGER], 1, (01 to 31)	2, 2006 1, 5 1, 30

Name of Parameter	Characters used [Printable String type], (length), (characters)	Data type [Type]	Text Notation (Length), (content)
Device type	10, "DVCATEGORY"	Printable String	5, "OTHER"
Vendor name	6, "VENDOR"	Printable String	24, "PROSOFT TECHNOLOGY, INC."
Product name	7, "DVMODEL"	Printable String	9, "MVI56-FLN"

Abstract Syntax of Profile

1) Type Definition

OtherRecord: :=	SEQUENCE
	{
	syspara SysparaType
	}
SysparaType: :=	SEQUENCE
	{
	nameCOMVER NameType
	paraCOMVER INTEGER
	nameID NameType
	paraID NameType
	nameREV NameType
	paraREV INTEGER
	nameREVDATE NameType
	paraREVDATE DateType
	nameDVCATEGORY NameType
	paraDVCATEGORY NameType
	nameVENDOR NameType
	paraVENDOR NameType
	nameDVMODEL NameType
	paraDVMODEL NameType
	}

2) Value Definition

	{
syspara	{
	nameCOMVER "COMVER",
	paraCOMVER 1,
	nameID "ID",
	paraID "SYSPARA",
	nameREV "REV",
	paraREV 0,
	nameREVDATE "REVDATE",

paraREVDATE	{
year	2006,
month	5,
day	30
	},
nameDVCATEGORY	"DVCATEGORY",
paraDVCATEGORY	"OTHER",
nameVENDOR	"VENDOR",
paraVENDOR	"PROSOFT TECHNOLOGY, INC.",
nameDVMODEL	"DVMODEL",
paraDVMODEL	"MVI56-FLN"
	}
	}

MVI56-FLN Transfer Syntax Data Array (Coding)

Identifier	Length													
30	8180													
30	7E													
13	06	"COMVER"												
02	01	1												
13	02	"ID"												
13	07	"SYSPARA"												
13	03	"REV"												
02	01	0												
13	07	"REVDATE"												
30	0A	<table border="1"> <thead> <tr> <th>Identifier</th> <th>Length</th> <th>Content</th> </tr> </thead> <tbody> <tr> <td>02</td> <td>02</td> <td>07D6</td> </tr> <tr> <td>02</td> <td>01</td> <td>05</td> </tr> <tr> <td>02</td> <td>01</td> <td>1E</td> </tr> </tbody> </table>	Identifier	Length	Content	02	02	07D6	02	01	05	02	01	1E
Identifier	Length	Content												
02	02	07D6												
02	01	05												
02	01	1E												
13	0A	"DVCATEGORY"												
13	05	"OTHER"												
13	06	"VENDOR"												
13	18	"PROSOFT TECHNOLOGY, INC."												
13	07	"DVMODEL"												
13	09	"MVI56-FLN"												

MVI56-FLN Profile Data Array

Relative Address

	0	1	2	3	4	5	6	7	8	9	A	B	C	D	E	F
00	30	81	80	30	7E	13	06	"C"	"O"	"M"	"V"	"E"	"R"	02	01	1
10	13	02	"I"	"D"	13	07	"S"	"Y"	"S"	"P"	"A"	"R"	"A"	13	03	"R"
20	"E"	"V"	02	01	00	13	07	"R"	"E"	"V"	"D"	"A"	"T"	"E"	30	0A
30	02	02	07	D6	02	01	05	02	01	1E	13	0A	"D"	"V"	"C"	"A"
40	"T"	"E"	"G"	"O"	"R"	"Y"	13	05	"O"	"T"	"H"	"E"	"R"	13	06	"V"
50	"E"	"N"	"D"	"O"	"R"	13	18	"P"	"R"	"O"	"S"	"O"	"F"	"T"	" "	"T"
60	"E"	"C"	"H"	"N"	"O"	"L"	"O"	"G"	"Y"	","	" "	"I"	"N"	"C"	"."	13
70	07	"D"	"V"	"M"	"O"	"D"	"E"	"L"	13	09	"M"	"V"	"I"	"5"	"6"	"."
80	"F"	"L"	"N"													

3.8 Communications Management Tables

Node status is managed using three types of management tables: Own node management tables, participating node management tables, and network management

3.8.1 Own Node Management Table

The own node management table manages the local node settings.

Item	Bytes	Contents (data range)
Node number	1 byte	1 to 249
Common Memory Area 1 first word	2 bytes	Word address (0 to 0xff)
Common Memory Area 1 data size	2 bytes	Size (0 to 0x200)
Common Memory Area 2 first word	2 bytes	Word address (0 to 0x2000)
Common Memory Area 2 data size	2 bytes	Size (0 to 0x200)
Upper layer status	2 bytes	RUN / STOP / ALARM / WARNING / NORMAL
Token monitoring time	1 byte	Unit: 1 ms
Minimum allowable frame interval	1 byte	Unit: 100 _s
Vendor code	10 bytes	Vendor code
Manufacturer model	10 bytes	Manufacturer model, device name
Node name (equipment name)	10 bytes	User-defined node name
Protocol version	1 byte	0x80 (fixed)
FA link status	1 byte	Participating, not participating, etc.
Local node status	1 byte	Duplicate node number detection, etc.

3.8.2 Participating Node Management Table

The participating node management table manages information on the nodes in the network.

Item	Bytes	Contents (data range)
Node number	1 byte	1 to 254 if participating (a zero in this field for a node indicates the node is not participating on the network)
Upper layer status	2 bytes	RUN / STOP / ALARM / WARNING / NORMAL
Common Memory Area 1 data first word	2 bytes	Word address (0 to 0x1ff)
Common Memory Area 1 data size	2 bytes	Size (0 to 0x200)
Common Memory Area 2 data first word	2 bytes	Word address (0 to 0x1fff)
Common Memory Area 2 data size	2 bytes	Size (0 to 0x2000)
Minimum allowable refresh cycle time	2 bytes	Unit: 1 ms
Token monitoring time	1 byte	Unit: 1 ms
Minimum allowable frame interval	1 byte	Unit: 100 ms
Link status	1 byte	Participating, not participating, etc.

3.8.3 Network Management Table

The network management table manages information that is shared by all nodes on the network.

Item	Bytes	Contents (data range)
Token holding node number	1 byte	Node currently holding the token
Minimum allowable frame interval	1 byte	Unit: 100_s
Allowable refresh cycle time	2 bytes	Unit: 1 ms
Refresh cycle measurement value (current)	2 bytes	Unit: 1 ms
Refresh cycle measurement value (maximum)	2 bytes	Unit: 1 ms
Refresh cycle measurement value (minimum)	2 bytes	Unit: 1 ms

3.8.4 Cyclic Transmission

Cyclic transmission is used to transmit cyclic data. The data is shared by each node through the Common Memory (shared memory) function.

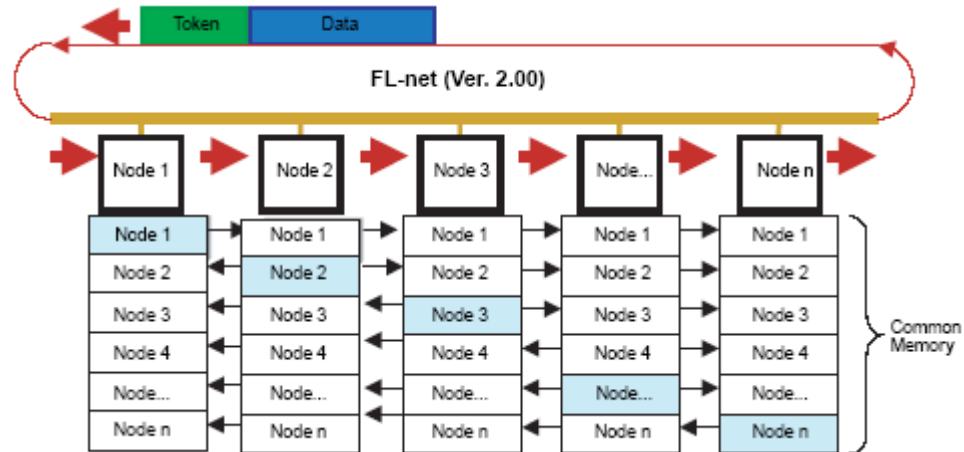

3.8.5 Volume of Transmission Data

An area of 0.5Kwords + 8Kwords = 8.5Kwords is provided for the whole network.

The maximum quantity of data that can be transmitted by a single node is 8.5Kwords. One word is equal to two bytes.

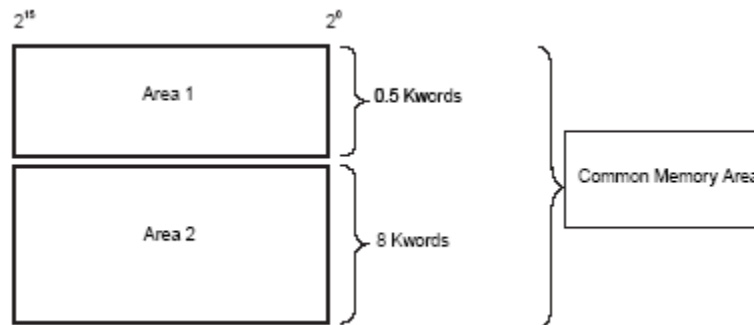

3.9 State Transition Diagram

This chapter describes the state transition.

3.9.1 A. State definitions

- 1 Initialization monitoring state: Waits for an initialization request from the upper layer and judges if the network link is established
- 2 Network initialization state: Link establishment state from a link non-establishment state.

- 3 Halfway joining initialization state: Up to the time when the self-node joins the network in the link establishment state.
- 4 Token waiting state: State where a token is not held in the link joining state.
- 5 Token holding state: State where a token is held in the link joining state.

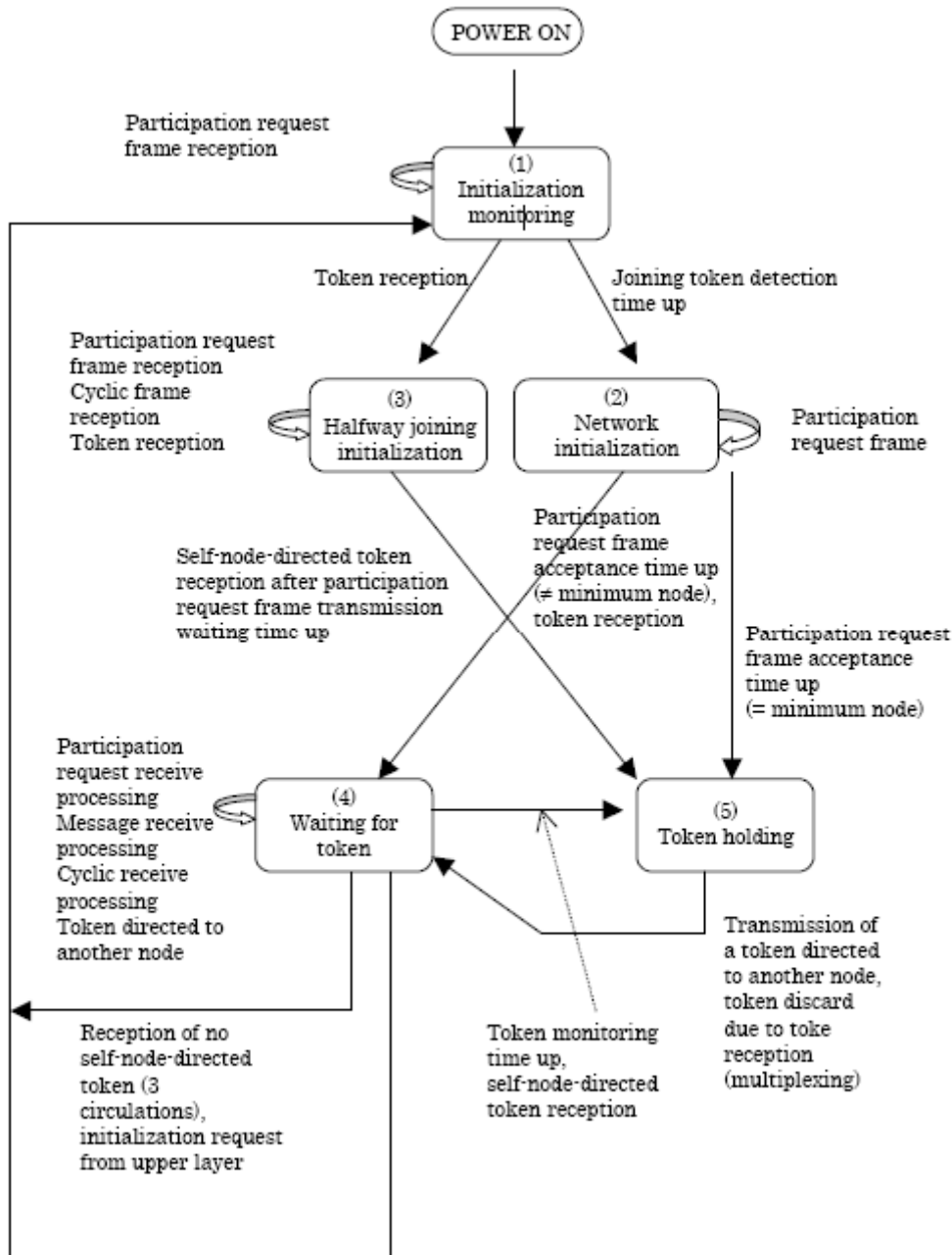

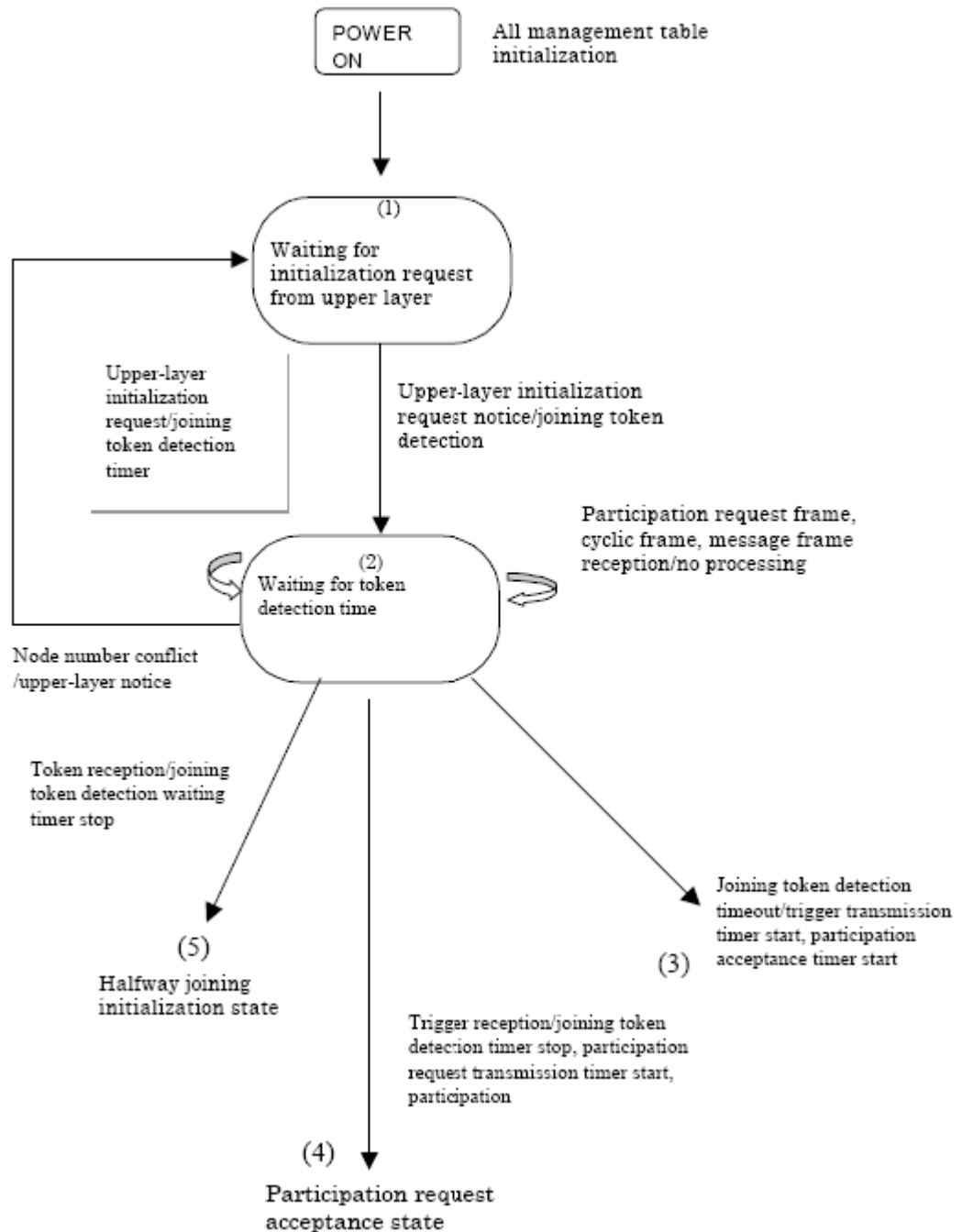
3.9.2 B. Initialization monitoring

State

Waiting for initialization request from upper layer

Because necessary information for joining the network such as self-node No. is not set, a joining operation cannot be started.

The node waits until the parameters that permit joining the network are set by the upper layer.

Waiting for joining token detection timeout Time for judging the current network status. The time starts after an initialization request from the upper layer is accepted. The monitoring time shall be 3 sec.

If even a token is received within this monitoring time, the network is judged as an operating status. When the network is in the operating status, the self-node in the network is put into the halfway joining initialization state.

When the network is not in the operating status, the self-node will join the network at network initialization.

3.9.3 C. Network initialization

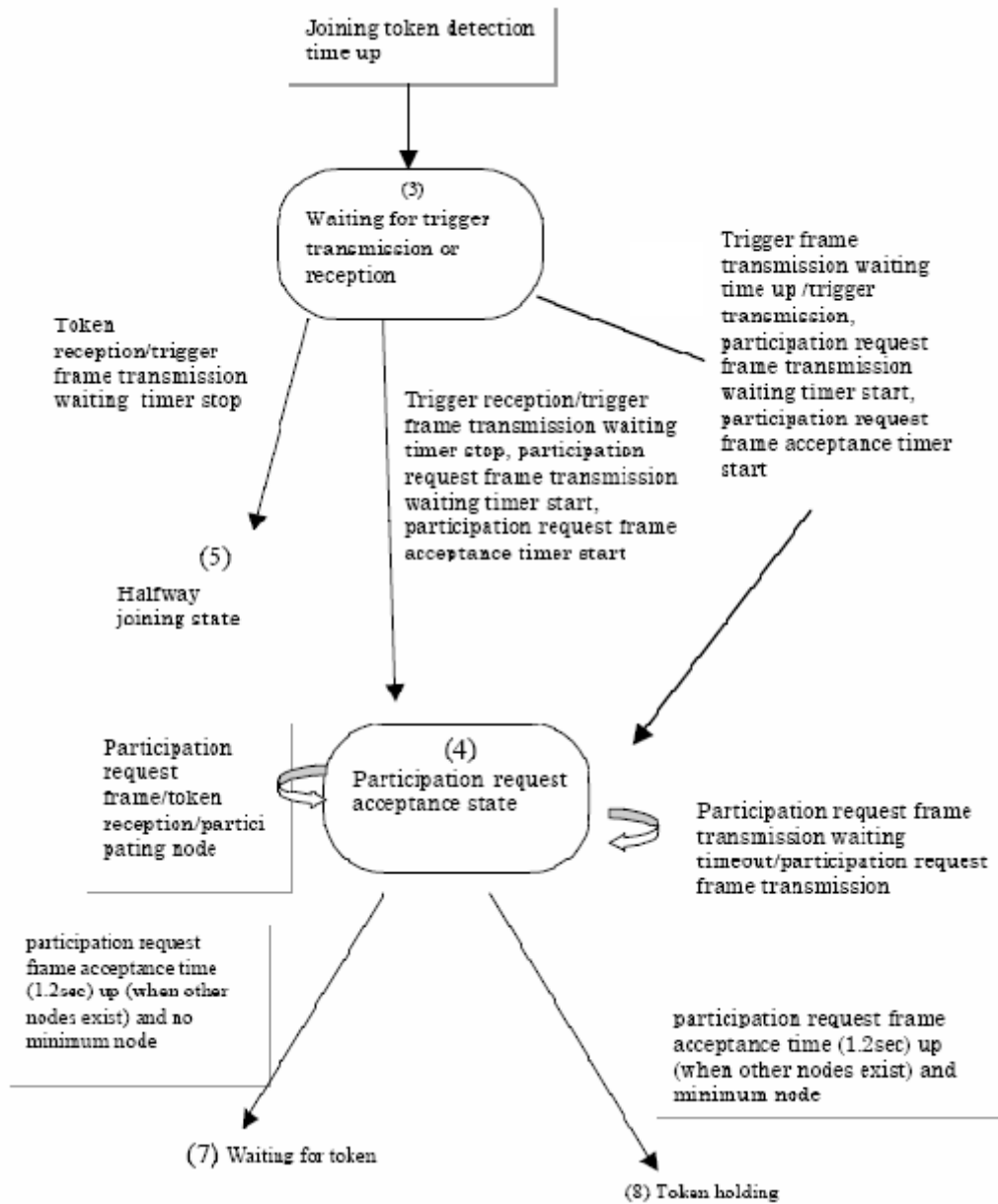

3.9.4 D. Halfway joining initialization

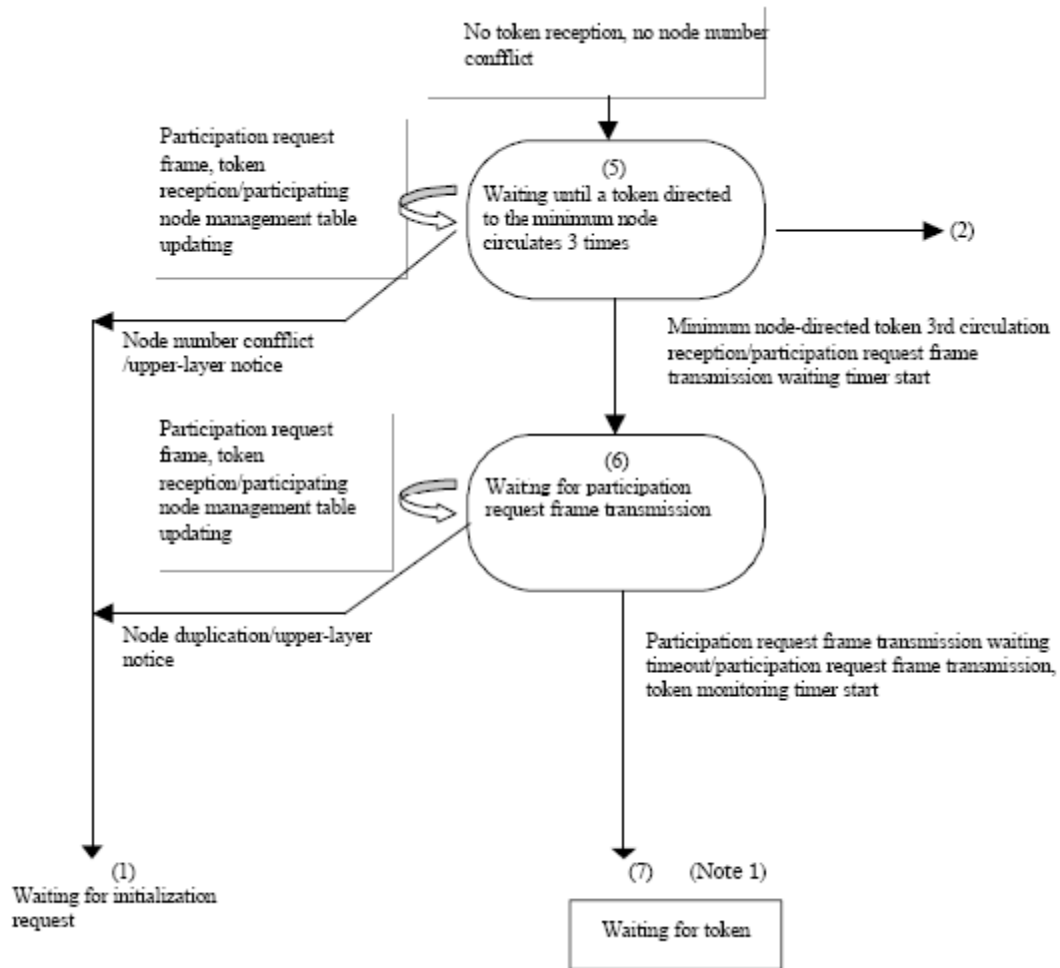

3.9.5 E. Waiting for token

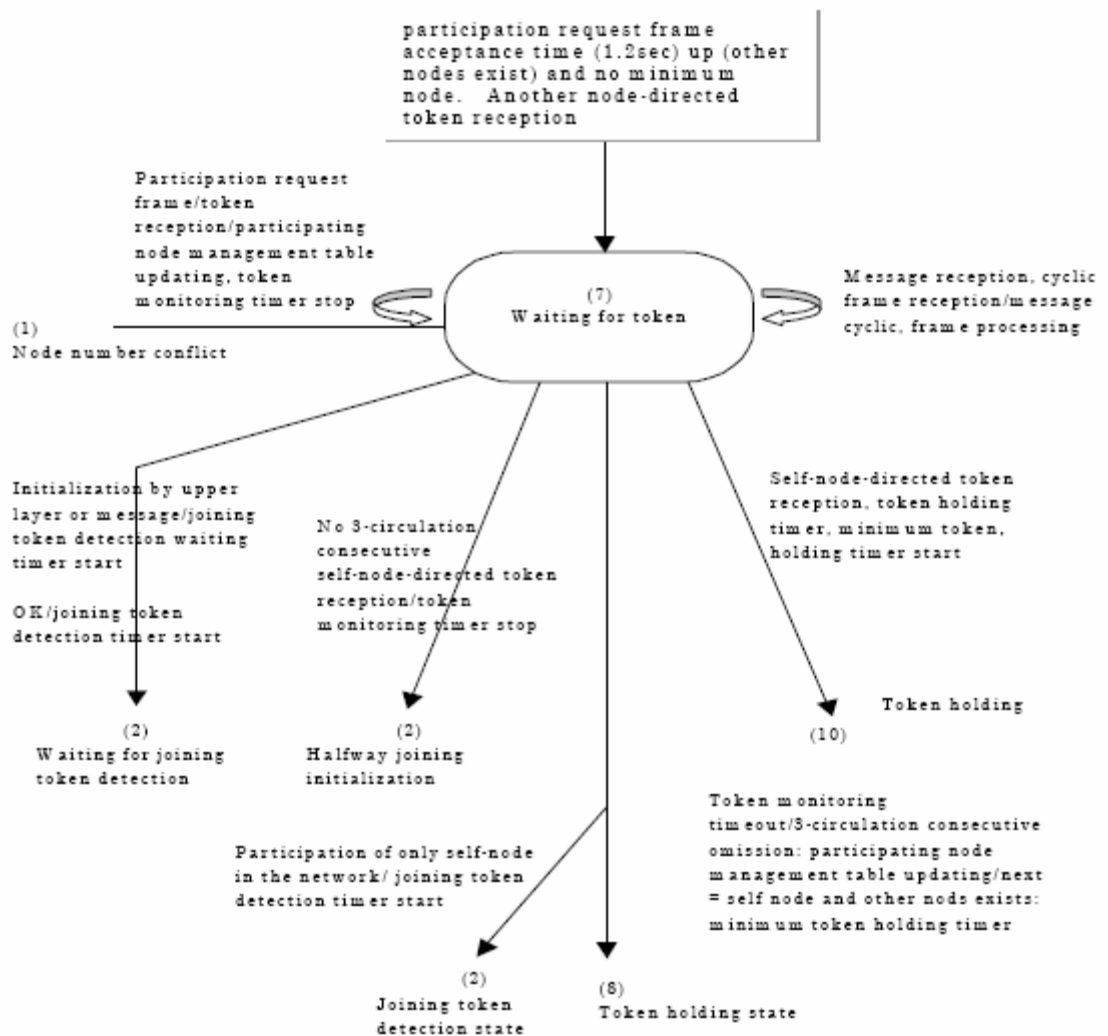

3.9.6 F. Token holding

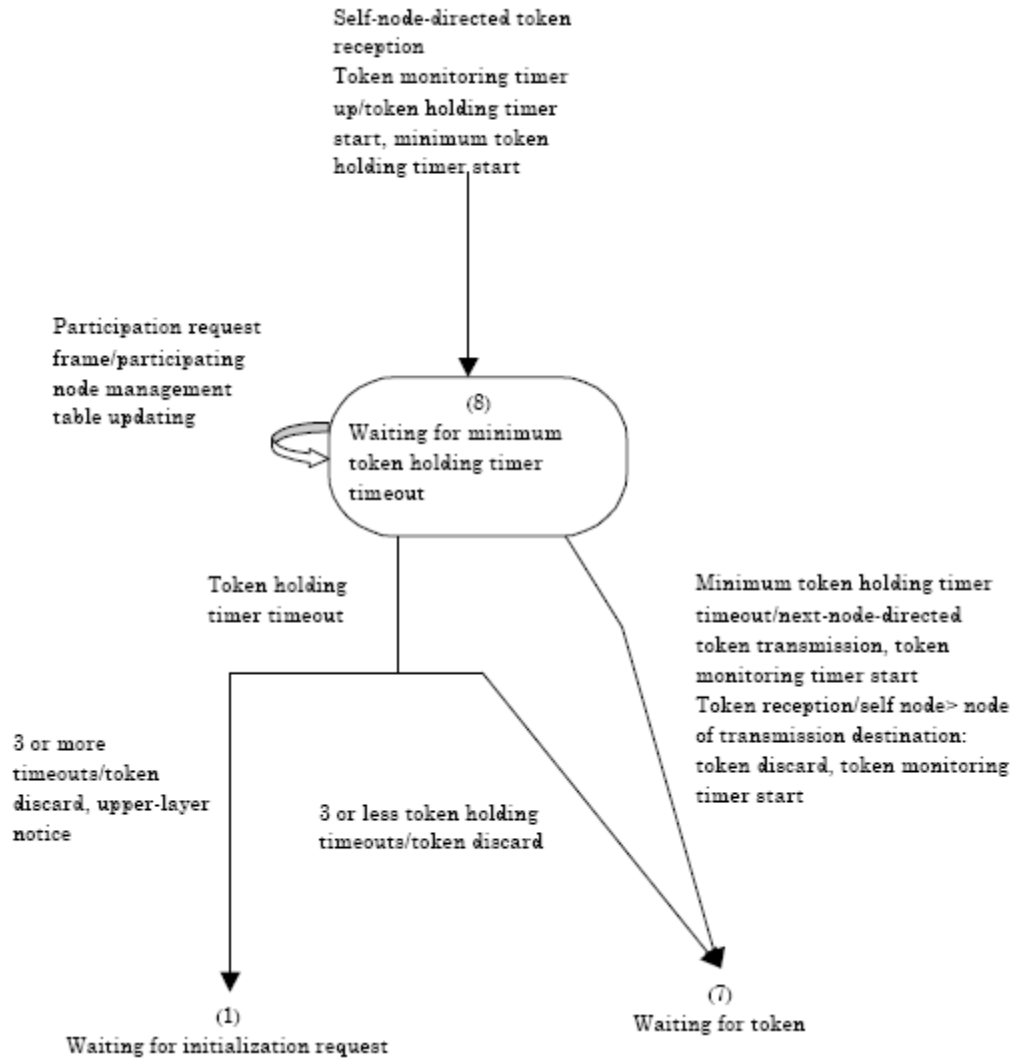

3.9.7 G. Message transmission state transition

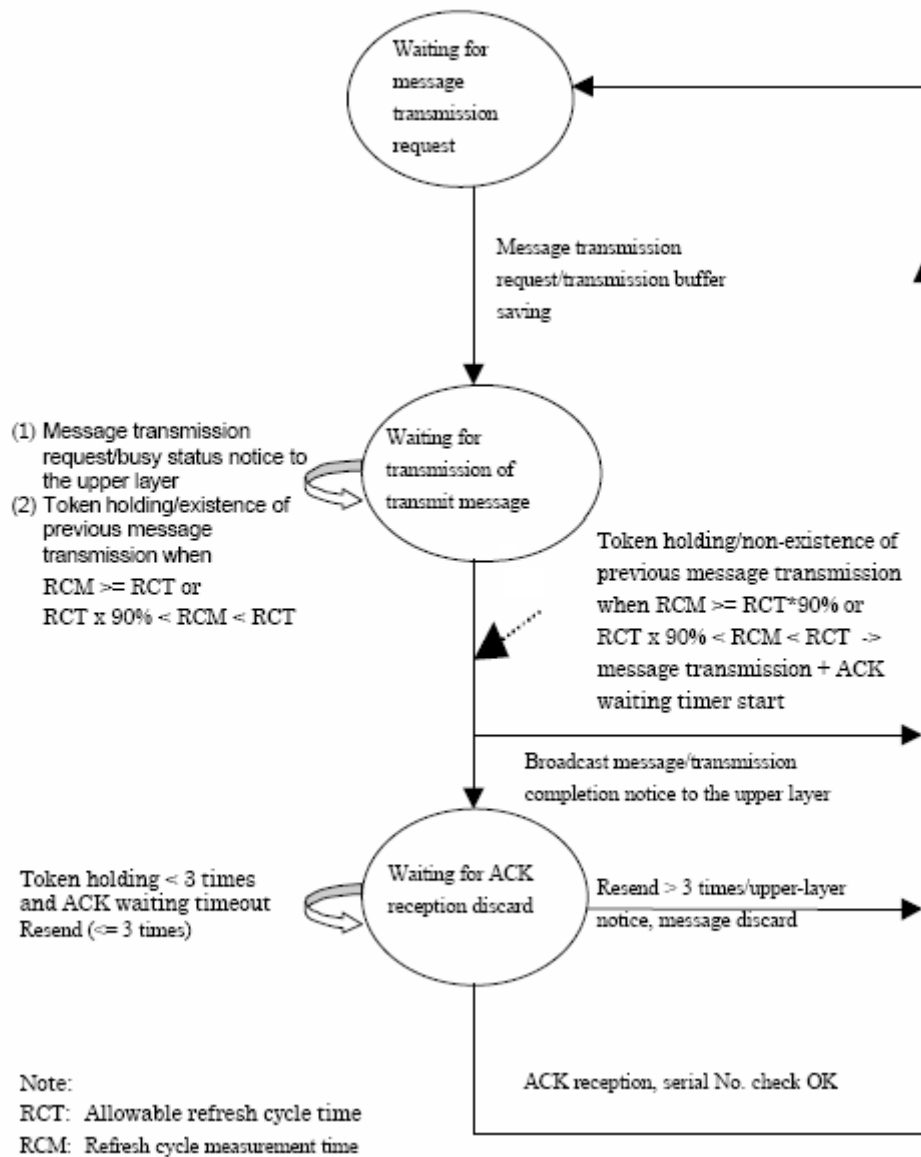

3.9.8 H. Message reception state transition

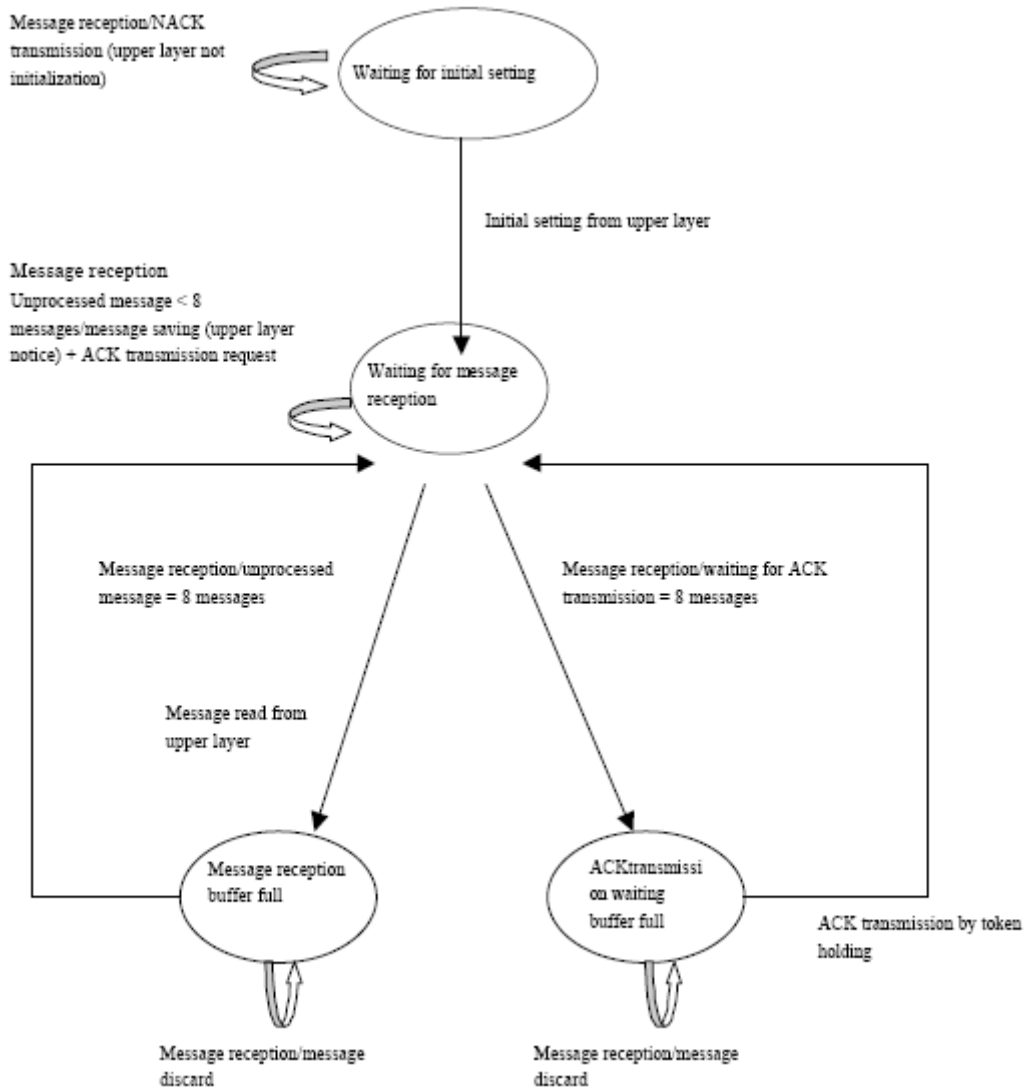

3.10 Glossary

Term	Definition
ACK	At communication by message transmission, the data receiving side notifies the transmitting side that the data has been received. This is used only for 1:1 message transmission.
Allowable minimum frame interval	This is the minimum value of frame interval that allows a node to receive a frame.
Allowable refresh cycle time	This time is used for a node to judge whether message transmission should be performed or not.
Bit area	This means a 1K-byte area in the common memory.
Common memory	A function that permits using a memory in common between nodes under cyclic transmission is provided.
Cyclic transmission	This function supports cyclic data exchange that occurs between nodes.
Ethernet	The physical layer and data link layer of the FA link protocol are specified.
FA network	This is an abbreviation of the FA control network.
Joining token detection time	This is the time to judge whether the network is in operation or not when joining the network. If a token is detected within this time, the network is regarded as being in operation.
Message transmission	This function supports non-cyclic data exchange that occurs between nodes.
Network management table	This table manages the common parameters on the network.
Participating node management table	This table manages the status of each node participating in the network.
Resend function	If ACK is not sent back from the receiving side at 1:1 message transmission, this function permits the transmitting side to resend a message.
Self-node management table	This table manages the information on the self-node.
Sequence number	This number is used to identify a message as a unique one at message transmission.
Version number	This number is used for message transmission. The version number is initialized by random number when a node is started.
Token monitoring time	This means the timeout period in which each node holds a token.
Word area	This means a 16K-byte area in the common memory.

4 Support, Service & Warranty

In This Chapter

- ❖ How to Contact Us: Sales and Support 127
- ❖ Return Material Authorization (RMA) Policies and Conditions..... 128
- ❖ Procedures for Return of Units Under Warranty 129
- ❖ Procedures for Return of Units Out of Warranty 130
- ❖ LIMITED WARRANTY 131

Be sure and read the full Warranty that can be found on our web site at www.prosoft-technology.com for details and other terms and conditions. The content in this summary is subject to change without notice. The content is current at date of publication.

ProSoft Technology, Inc. strives to provide meaningful support to its customers. Should any questions or problems arise, please feel free to contact us at:

Internet	Web Site: http://www.prosoft-technology.com/support
	E-mail address: support@prosoft-technology.com

Those of us at ProSoft Technology, Inc. want to provide the best and quickest support possible, so before calling please have the following information available. You may wish to fax this information to us prior to calling.

- 1 Product Version Number
- 2 System architecture
- 3 Network details

In the case of hardware, we will also need the following information:

- 1 Module configuration and contents of file
- 2 Module Operation
- 3 Configuration/Debug status information
- 4 LED patterns
- 5 Information about the processor and user data files as viewed through the development software and LED patterns on the processor
- 6 Details about the networked devices interfaced, if any

For technical support calls within the United States, an after-hours answering system allows pager access to one of our qualified technical and/or application support engineers at any time to answer your questions.

4.1 How to Contact Us: Sales and Support

All ProSoft Technology Products are backed with full technical support. Contact our worldwide Technical Support team and Customer Service representatives directly by phone or email:

USA / Latin America (excluding Brasil) (Office in California)

+1.661.716.5100
+1.661.716.5101 (Fax)
1675 Chester Avenue, 4th Floor
Bakersfield, California 93301
U.S.A.
+1.661.716.5100, support@prosoft-technology.com
Languages spoken include: English, Spanish

Asia Pacific Sales (office in Malaysia)

+603.7724.2080
+603.7724.2090 (Fax)
C210, Damansara Intan,
1 Jalan SS20/27, 47400 Petaling Jaya
Selangor, Malaysia
+603.7724.2080, asiapc@prosoft-technology.com
Languages spoken include: Chinese, Japanese, English

Asia Pacific Support (office in China)

+86.21.64518356 x 8011
+86.21.64756957 (Fax)
4/F, No. 16 Hongcao Road
Shanghai, China 200233
China
+86.21.64518356 x 8011, zhang@prosoft-technology.com
Languages spoken include: Chinese, English

Europe / Middle East / Africa (office in Toulouse, France)

+33 (0) 5.34.36.87.20
+33 (0) 5.61.78.40.52 (Fax)
Zone d'activité de Font Grasse
17, rue des Briquetiers
F-31700 Blagnac
France
+33 (0) 5.34.36.87.20. support.emea@prosoft-technology.com
Languages spoken include: French, English

Brasil (office in Sao Paulo)

+55.11.5084.5178
Rua Vergueiro, 2949 - sala 182 - Edifício Vergueiro Work Center
Vila Mariana - São Paulo
Cep: 04101-300 - Brasil
+55.11.5083.3776, amarana@prosoft-technology.com
Languages spoken: Portuguese

4.2 Return Material Authorization (RMA) Policies and Conditions

The following RMA Policies and Conditions apply to any returned product. These RMA Policies are subject to change by ProSoft without notice. For warranty information, see Section C below entitled "Limited Warranty". In the event of any inconsistency between the RMA Policies and the Warranty, the Warranty shall govern.

4.2.1 All Product Returns

- 1** In order to return a Product for repair, exchange or otherwise, the Customer must obtain a Returned Material Authorization (RMA) number from ProSoft and comply with ProSoft shipping instructions.

- 2 In the event that the Customer experiences a problem with the Product for any reason, Customer should contact ProSoft Technical Support at one of the telephone numbers listed above in Section A. A Technical Support Engineer will request several tests in an attempt to isolate the problem. If after these tests are completed, the Product is found to be the source of the problem, ProSoft will issue an RMA.
- 3 All returned Products must be shipped freight prepaid, in the original shipping container or equivalent, to the location specified by ProSoft, and be accompanied by proof of purchase. The RMA number is to be prominently marked on the outside of the shipping box. Customer agrees to insure the Product or assume the risk of loss or damage in transit. Products shipped to ProSoft without an RMA number will be returned to the Customer, freight collect. Contact ProSoft Technical Support for further information.
- 4 Out of warranty returns are not allowed on RadioLinx accessories such as antennas, cables, and brackets.

The following policy applies for Non-Warranty Credit Returns:

- A 10% Restocking Fee if Factory Seal is *not* broken
- B 20% Restocking Fee if Factory Seal is broken

ProSoft retains the right, in its absolute and sole discretion, to reject any non-warranty returns for credit if the return is not requested within three (3) months after shipment of the Product to Customer, if the Customer fails to comply with ProSoft's shipping instructions, or if the Customer fails to return the Product to ProSoft within six (6) months after Product was originally shipped.

4.3 Procedures for Return of Units Under Warranty

- 1 A Technical Support Engineer must pre-approve all product returns.
- 2 Module is repaired or replaced after a Return Material Authorization Number is entered and a replacement order is generated.
- 3 Credit for the warranted item is issued within 10 business days after receipt of product and evaluation of the defect has been performed by ProSoft. The credit will only be issued provided the product is returned with a valid Return Material Authorization Number and in accordance with ProSoft's shipping instructions.

- a) If no defect is found, a credit is issued.
- b) If a defect is found and is determined to be customer generated or if the defect is otherwise not covered by ProSoft's Warranty, or if the module is not repairable, a credit is not issued and payment of the replacement module is due.

4.4 Procedures for Return of Units Out of Warranty

- 1 Customer sends unit in for evaluation.
- 2 If no defect is found, Customer will be charged the equivalent of US \$100 plus shipping, duties and taxes that may apply. A new Purchase Order will be required for this evaluation fee.

If the unit is repaired the charge to the Customer will be 30%* of the list price plus any shipping, duties and taxes that may apply. A new Purchase Order will be required for a product repair.

- 3 For an immediate exchange, a new module may be purchased and sent to Customer while repair work is being performed. Credit for purchase of the new module will be issued when the new module is returned in accordance with ProSoft's shipping instructions and subject to ProSoft's policy on non-warranty returns. This is in addition to charges for repair of the old module and any associated charges to Customer.
- 4 If, upon contacting ProSoft Customer Service, the Customer is informed that unit is believed to be unrepairable, the Customer may choose to send unit in for evaluation to determine if the repair can be made. Customer will pay shipping, duties and taxes that may apply. If unit cannot be repaired, the Customer may purchase a new unit.

4.4.1 Un-repairable Units

- 3150-All
- 3750
- 3600-All
- 3700
- 3170-All
- 3250
- 1560 can be repaired, if defect is the power supply
- 1550 can be repaired, if defect is the power supply
- 3350
- 3300
- 1500-All

*** 30% of list price is an estimated repair cost only. The actual cost of repairs will be determined when the module is received by ProSoft and evaluated for needed repairs.**

4.4.2 Purchasing Warranty Extension

As detailed below in ProSoft's Warranty, the standard Warranty Period is one year (or in the case of RadioLinx modules, three years) from the date of delivery. The Warranty Period may be extended for an additional charge, as follows:

- Additional 1 year = 10% of list price
- Additional 2 years = 20% of list price
- Additional 3 years = 30% of list price

4.5 LIMITED WARRANTY

This Limited Warranty ("Warranty") governs all sales of hardware, software and other products (collectively, "Product") manufactured and/or offered for sale by ProSoft, and all related services provided by ProSoft, including maintenance, repair, warranty exchange, and service programs (collectively, "Services"). By purchasing or using the Product or Services, the individual or entity purchasing or using the Product or Services ("Customer") agrees to all of the terms and provisions (collectively, the "Terms") of this Limited Warranty. All sales of software or other intellectual property are, in addition, subject to any license agreement accompanying such software or other intellectual property.

4.5.1 What Is Covered By This Warranty

A *Warranty On New Products:* ProSoft warrants, to the original purchaser only, that the Product that is the subject of the sale will (1) conform to and perform in accordance with published specifications prepared, approved, and issued by ProSoft, and (2) will be free from defects in material or workmanship; provided these warranties only cover Product that is sold as new. This Warranty expires one year (or in the case of RadioLinx modules, three years) from the date of shipment (the "Warranty Period"). If the Customer discovers within the Warranty Period a failure of the Product to conform to specifications, or a defect in material or workmanship of the Product, the Customer must promptly notify ProSoft by fax, email or telephone. In no event may that notification be received by ProSoft later than 15 months (or in the case of RadioLinx modules, 39 months) from the date of delivery. Within a reasonable time after notification, ProSoft will correct any failure of the Product to conform to specifications or any defect in material or workmanship of the Product, with either new or used replacement parts. Such repair, including both parts and labor, will be performed at ProSoft's expense. All warranty service will be performed at service centers designated by ProSoft. If ProSoft is unable to repair the Product to conform to this Warranty after a reasonable number of attempts, ProSoft will provide, at its option, one of the following: a replacement product, a full refund of the purchase price or a credit in the amount of the purchase price. All replaced product and parts become the property of ProSoft. These remedies are the Customer's only remedies for breach of warranty.

- B** *Warranty On Services:* Material and labor used by ProSoft to repair a verified malfunction or defect are warranted on the terms specified above for new Product, provided said warranty will be for the period remaining on the original new equipment warranty or, if the original warranty is no longer in effect, for a period of 90 days from the date of repair.
- C** The Warranty Period for RadioLinx accessories (such as antennas, cables, brackets, etc.) are the same as for RadioLinx modules, that is, three years from the date of shipment.

4.5.2 What Is Not Covered By This Warranty

- A** ProSoft makes no representation or warranty, expressed or implied, that the operation of software purchased from ProSoft will be uninterrupted or error free or that the functions contained in the software will meet or satisfy the purchaser's intended use or requirements; the Customer assumes complete responsibility for decisions made or actions taken based on information obtained using ProSoft software.
- B** With the exception of RadioLinx accessories referenced in paragraph 1(c) this Warranty does not cover any product, components, or parts not manufactured by ProSoft.
- C** This Warranty also does not cover the failure of the Product to perform specified functions, or any other non-conformance, defects, losses or damages caused by or attributable to any of the following: (i) shipping; (ii) improper installation or other failure of Customer to adhere to ProSoft's specifications or instructions; (iii) unauthorized repair or maintenance; (iv) attachments, equipment, options, parts, software, or user-created programming (including, but not limited to, programs developed with any IEC 61131-3 programming languages, or "C") not furnished by ProSoft; (v) use of the Product for purposes other than those for which it was designed; (vi) any other abuse, misapplication, neglect or misuse by the Customer; (vii) accident, improper testing or causes external to the Product such as, but not limited to, exposure to extremes of temperature or humidity, power failure or power surges outside of the limits indicated on the product specifications; or (viii) disasters such as fire, flood, earthquake, wind or lightning.
- D** The information in this Agreement is subject to change without notice. ProSoft shall not be liable for technical or editorial errors or omissions made herein; nor for incidental or consequential damages resulting from the furnishing, performance or use of this material. The user guides included with your original product purchased by you from ProSoft, contains information protected by copyright. No part of the guide may be duplicated or reproduced in any form without prior written consent from ProSoft.

4.5.3 DISCLAIMER REGARDING HIGH RISK ACTIVITIES

PRODUCT MANUFACTURED OR SUPPLIED BY PROSOFT IS NOT FAULT TOLERANT AND IS NOT DESIGNED, MANUFACTURED OR INTENDED FOR USE IN HAZARDOUS ENVIRONMENTS REQUIRING FAIL-SAFE PERFORMANCE (INCLUDING, WITHOUT LIMITATION, THE OPERATION OF NUCLEAR FACILITIES, AIRCRAFT NAVIGATION OF COMMUNICATION SYSTEMS, AIR TRAFFIC CONTROL, DIRECT LIFE SUPPORT MACHINES OR WEAPONS SYSTEMS), IN WHICH THE FAILURE OF THE PRODUCT COULD LEAD DIRECTLY OR INDIRECTLY TO DEATH, PERSONAL INJURY, OR SEVERE PHYSICAL OR ENVIRONMENTAL DAMAGE (COLLECTIVELY, "HIGH RISK ACTIVITIES"). PROSOFT SPECIFICALLY DISCLAIMS ANY EXPRESS OR IMPLIED WARRANTY OF FITNESS FOR HIGH RISK ACTIVITIES.

4.5.4 DISCLAIMER OF ALL OTHER WARRANTIES

THE WARRANTIES SET FORTH IN PARAGRAPH 1 ABOVE ARE IN LIEU OF ALL OTHER WARRANTIES, EXPRESS OR IMPLIED, INCLUDING BUT NOT LIMITED TO THE IMPLIED WARRANTIES OF MERCHANTABILITY AND FITNESS FOR A PARTICULAR PURPOSE.

4.5.5 LIMITATION OF REMEDIES**

IN NO EVENT WILL PROSOFT (OR ITS DEALER) BE LIABLE FOR ANY SPECIAL, INCIDENTAL, OR CONSEQUENTIAL DAMAGES BASED ON BREACH OF WARRANTY, BREACH OF CONTRACT, NEGLIGENCE, STRICT TORT, OR ANY OTHER LEGAL THEORY. DAMAGES THAT PROSOFT AND ITS DEALER WILL NOT BE RESPONSIBLE FOR INCLUDE, BUT ARE NOT LIMITED TO: LOSS OF PROFITS; LOSS OF SAVINGS OR REVENUE; LOSS OF USE OF THE PRODUCT OR ANY ASSOCIATED EQUIPMENT; LOSS OF DATA; COST OF CAPITAL; COST OF ANY SUBSTITUTE EQUIPMENT, FACILITIES, OR SERVICES; DOWNTIME; THE CLAIMS OF THIRD PARTIES, INCLUDING CUSTOMERS OF THE PURCHASER; AND INJURY TO PROPERTY.

** Some areas do not allow time limitations on an implied warranty, or allow the exclusion or limitation of incidental or consequential damages. In such areas the above limitations may not apply. This Warranty gives you specific legal rights, and you may also have other rights which vary from place to place.

4.5.6 Time Limit for Bringing Suit

Any action for breach of warranty must be commenced within 15 months (or in the case of RadioLinx modules, 39 months) following shipment of the Product.

4.5.7 No Other Warranties

Unless modified in writing and signed by both parties, this Warranty is understood to be the complete and exclusive agreement between the parties, suspending all oral or written prior agreements and all other communications between the parties relating to the subject matter of this Warranty, including statements made by salesperson. No employee of ProSoft or any other party is authorized to make any warranty in addition to those made in this Warranty. The Customer is warned, therefore, to check this Warranty carefully to see that it correctly reflects those terms that are important to the Customer.

4.5.8 Intellectual Property

- A** Any documentation included with Product purchased from ProSoft is protected by copyright and may not be photocopied or reproduced in any form without prior written consent from ProSoft.
- B** ProSoft's technical specifications and documentation that are included with the Product are subject to editing and modification without notice.
- C** Transfer of title shall not operate to convey to Customer any right to make, or have made, any Product supplied by ProSoft.
- D** Customer is granted no right or license to use any software or other intellectual property in any manner or for any purpose not expressly permitted by any license agreement accompanying such software or other intellectual property.
- E** Customer agrees that it shall not, and shall not authorize others to, copy software provided by ProSoft (except as expressly permitted in any license agreement accompanying such software); transfer software to a third party separately from the Product; modify, alter, translate, decode, decompile, disassemble, reverse-engineer or otherwise attempt to derive the source code of the software or create derivative works based on the software; export the software or underlying technology in contravention of applicable US and international export laws and regulations; or use the software other than as authorized in connection with use of Product.

4.5.9 Additional Restrictions Relating To Software And Other Intellectual Property

In addition to complying with the Terms of this Warranty, Customers purchasing software or other intellectual property shall comply with any license agreement accompanying such software or other intellectual property. Failure to do so may void this Warranty with respect to such software and/or other intellectual property.

4.5.10 Allocation of risks

This Warranty allocates the risk of product failure between ProSoft and the Customer. This allocation is recognized by both parties and is reflected in the price of the goods. The Customer acknowledges that it has read this Warranty, understands it, and is bound by its Terms.

4.5.11 Controlling Law and Severability

This Warranty shall be governed by and construed in accordance with the laws of the United States and the domestic laws of the State of California, without reference to its conflicts of law provisions. If for any reason a court of competent jurisdiction finds any provisions of this Warranty, or a portion thereof, to be unenforceable, that provision shall be enforced to the maximum extent permissible and the remainder of this Warranty shall remain in full force and effect. Any cause of action with respect to the Product or Services must be instituted in a court of competent jurisdiction in the State of California.

Index

A

A. State definitions • 115
 About FL-net Protocol • 75
 Abstract Syntax of Profile • 111
 Adding a Module • 25
 Adding a Project • 25
 Additional Restrictions Relating To Software And Other Intellectual Property • 134
 Address Setting • 95
 All Product Returns • 128
 Allocation of risks • 134
 Allowable minimum frame interval • 97
 Allowable refresh cycle time • 97
 Area 1 and area 2 • 79
 Assignment of Area 1 and Area 2 • 80
 Assignment of common memory • 98

B

B. Initialization monitoring • 117
 Backplane Data Transfer • 81
 Basic Ethernet • 70
 Battery Life Advisory • 3

C

C. Network initialization • 119
 Cable Connections • 37
 Checking Status through ControlLogix Controller Tags • 54
 Checking the Backplane status • 61
 Checking the General Network Status • 60
 Checking the Log Data • 52, 59
 Checking the Nodes Exchanging Data • 49, 55
 Checking the Own Node Status • 53, 54
 Checking the Participating Node Status • 52, 56
 Checking the Participating Nodes • 50
 Checking the Participation Table • 55
 Choose the Controller Type • 19
 Comment Entries • 27
 Common memory • 77
 Common memory area size that one node should have • 80
 Common Memory Function • 78
 Common memory is divided by each node not to be overlapped. • 99
 Communications Management Tables • 113
 Configure Area 1 and Area 2 • 28
 Configure the General Parameters • 30
 Configure the MVI56-FLN Module • 23
 Configure the Node Number • 35
 Configuring RSLinx • 21
 Connect the MVI56-FLN Module to the FL/ET-T-V2 • 47

Connect your PC to the Module • 23
 Connect your PC to the Processor • 16
 Controlling Law and Severability • 135
 Cyclic Transmission • 115
 Cyclic Transmission Function • 77

D

D. Halfway joining initialization • 120
 Data Communication Between Nodes • 76
 Data Communications • 99
 Data Flow between Module and Processor • 86
 Data Frame ID of FL-net • 100
 Data Mapping Functionality • 30
 Data Share Function • 77
 Data volume and number of frames • 104
 DB9 to RJ45 Adaptor (Cable 14) • 40
 Diagnostics and Troubleshooting • 9, 67
 Disabling the RSLinx Driver for the Com Port on the PC • 38, 48
 DISCLAIMER OF ALL OTHER WARRANTIES • 133
 DISCLAIMER REGARDING HIGH RISK ACTIVITIES • 133
 Download the Project • 47
 Download the Project to the Module • 36
 Download the Sample Program to the Processor • 20

E

E. Waiting for token • 121
 Error and Status Data • 109
 Ethernet Configuration • 35
 Ethernet Connection • 37
 Ethernet LED Indicators • 71
 Ethernet Port Configuration - wattcp.cfg • 38
 Example 1 • 30
 Example 2 • 33

F

F. Token holding • 122
 FA link protocol • 108
 FA link status • 92
 Features • 73
 FL/ET-V2 Configuration with PCwin • 42
 FL-net Device Profile for MVI56-FLN Module • 110
 FL-net Node Configuration Parameters • 30, 96
 FL-net Protocol and network • 98
 Functional Overview • 9, 75
 Functional Specifications • 74

G

G. Message transmission state transition • 123
 Glossary • 125
 Guide to the MVI56-FLN User Manual • 9

H

H. Message reception state transition • 124
 How to Contact Us
 Sales and Support • 127

I

Implementation of FL-net • 87
Information Tables • 87
In-ring and out-ring management • 108
Install ProSoft Configuration Builder Software • 13
Install the Module in the Rack • 14
Intellectual Property • 134
Introduction • 30
IP address • 95

K

Keystrokes • 49, 70

L

LED Status Indicators • 70
LIMITATION OF REMEDIES** • 133
LIMITED WARRANTY • 131
Link Status Byte • 72
Lower Layer Protocol • 95

M

MAC address • 95
Main Logic Loop • 81
Masterless Transmission Management • 106
Memory Resources • 98
Message Transmission Function • 102
Message Transmission Services • 102
Message Transmissions • 101
Module Entries • 27
Module Power Up • 81
Module's Cyclic Input Data • 86
Module's Cyclic Output Data • 87
Multiple frames of cyclic data • 100
MVI56-FLN Block Assignments Summary • 81
MVI56-FLN Profile Data Array • 113
MVI56-FLN Transfer Syntax Data Array (Coding) • 112

N

Navigation • 49, 69
Network Management • 105
Network management table • 90
Network Management Table • 114
No Other Warranties • 134
Node for Reception Only • 78
Node Having No Common Memory • 79
Node name (equipment name) • 96
Node Number • 96
Number of Connectable Nodes and Node Numbers • 98

O

Open the Sample Ladder Logic in RSLogix • 17
Own node management table • 89
Own Node Management Table • 113
Own Status Byte • 71
Own-Node Status information • 71

P

Package Contents • 13
Participating Node Management Table • 89, 114
Please Read This Notice • 2
Port number • 95
Printing a Configuration File • 27
Procedures for Return of Units Out of Warranty • 130
Procedures for Return of Units Under Warranty • 129
Product Description • 73
Product Specifications • 9, 73
ProSoft Configuration Builder • 24
ProSoft® Product Documentation • 3
Purchasing Warranty Extension • 131

R

Read Block • 82
Reference • 9, 73
Required Hardware • 67
Return Material Authorization (RMA) Policies and Conditions • 128
RS-232 Configuration/Debug Port • 38

S

Sample Ladder Logic • 17
Select the Slot Number for the Module • 20
Self-node status • 94
Set Module Parameters • 26
Set Operation Mode Switch • 41
Set Up the Project • 24
Setting the Mapping Parameters • 32
Setup the FL/ET-T-V2 Module • 41
Setup the FL/ET-V2 Link Parameters • 43
Special Blocks • 84
Specify I/O Module ID Code • 42
Start Here • 9, 11
State • 118
State Transition Diagram • 115
Status Data • 88, 89, 109
Support, Service & Warranty • 9, 127
System Requirements • 12

T

Text Notation of Profile • 110
The Configuration/Debug Menu • 48, 68
Time Limit for Bringing Suit • 133
Timer Types • 94
Token • 106
Token and frames • 107
Token flow • 106
Token monitoring time • 97
Top address and data size of common memory transmitting area • 96
Transferring Data • 61
Transferring Data from FL/ET-T-V2 Link Area to MVI56-FLN Area 1 • 64
Transferring Data from FL/ET-T-V2 Register Area to MVI56-FLN Area 2 • 66
Transferring Data from MVI56-FLN (Area 1) to FL/ET-T-V2 module (Relay Area) • 62

Transferring Data from MVI56-FLN (Area 2) to FL/ET-
T-V2 module (Register Area) • 65
Transmission Cycle • 99
Troubleshooting • 71
Types of management table • 87

U

Understanding the Basics of FL-net • 98
Un-repairable Units • 130
Upper layer status • 90
Upper Layer Status Read Definition • 72, 90
Upper Layer Status Table • 91
Upper Layer Status Word • 72
User-defined Specifications • 75
Using the Configuration/Debug Port • 47
Using the Diagnostic Window in ProSoft Configuration
Builder • 68
Using the Module Debug Menu • 49

V

Verifying Communication • 9, 47
Volume of Transmission Data • 115

W

Warnings • 2
What Is Covered By This Warranty • 131
What Is Not Covered By This Warranty • 132
Write Block • 83

Y

Your Feedback Please • 4