



Where Automation Connects.



## **MVI69E-LDM**

**"C" Programmable**

Linux® Application Development  
Module

August 3, 2020

**DEVELOPER'S GUIDE**

## Your Feedback Please

We always want you to feel that you made the right decision to use our products. If you have suggestions, comments, compliments or complaints about our products, documentation, or support, please write or call us.

### ProSoft Technology, Inc.

+1 (661) 716-5100

+1 (661) 716-5101 (Fax)

[www.prosoft-technology.com](http://www.prosoft-technology.com)

[support@prosoft-technology.com](mailto:support@prosoft-technology.com)

© 2020 ProSoft Technology, Inc. All rights reserved.

MVI69E-LDM Developer's Guide

August 3, 2020

ProSoft Technology®, is a registered copyright of ProSoft Technology, Inc. All other brand or product names are or may be trademarks of, and are used to identify products and services of, their respective owners.

In an effort to conserve paper, ProSoft Technology no longer includes printed manuals with our product shipments. User Manuals, Datasheets, Sample Ladder Files, and Configuration Files are provided at:

[www.prosoft-technology.com](http://www.prosoft-technology.com)



### For professional users in the European Union

If you wish to discard electrical and electronic equipment (EEE), please contact your dealer or supplier for further information.



**Prop 65 Warning** – Cancer and Reproductive Harm – [www.P65Warnings.ca.gov](http://www.P65Warnings.ca.gov)

## MVI (Multi Vendor Interface) Modules

WARNING - EXPLOSION HAZARD - DO NOT DISCONNECT EQUIPMENT UNLESS POWER HAS BEEN SWITCHED OFF OR THE AREA IS KNOWN TO BE NON-HAZARDOUS.

AVERTISSEMENT - RISQUE D'EXPLOSION - AVANT DE DÉCONNECTER L'ÉQUIPEMENT, COUPER LE COURANT OU S'ASSURER QUE L'EMPLACEMENT EST DÉSIGNÉ NON DANGEREUX.

## Important Installation Instructions

Power, Input, and Output (I/O) wiring must be in accordance with Class I, Division 2 wiring methods, Article 501-4 (b) of the National Electrical Code, NFPA 70 for installation in the U.S., or as specified in Section 18-1J2 of the Canadian Electrical Code for installations in Canada, and in accordance with the authority having jurisdiction. The following warnings must be heeded:

**WARNING** - EXPLOSION HAZARD - SUBSTITUTION OF COMPONENTS MAY IMPAIR SUITABILITY FOR CLASS I, DIV. 2;

**WARNING** - EXPLOSION HAZARD - WHEN IN HAZARDOUS LOCATIONS, TURN OFF POWER BEFORE REPLACING OR WIRING MODULES

**WARNING** - EXPLOSION HAZARD - DO NOT DISCONNECT EQUIPMENT UNLESS POWER HAS BEEN SWITCHED OFF OR THE AREA IS KNOWN TO BE NON-HAZARDOUS.

### Class 2 Power

## Warnings, Specification, and Certifications

### North America Warnings

- A** Warning - Explosion Hazard - Substitution of components may impair suitability for Class I, Division 2.
- B** Warning - Explosion Hazard - When in Hazardous Locations, turn off power before replacing or rewiring modules.
- C** Warning - Explosion Hazard - Do not disconnect equipment unless power has been switched off or the area is known to be non-hazardous.
- D** Suitable for use in Class I, Division 2 Groups A, B, C and D Hazardous Locations or Non-Hazardous Locations only.
- E** The subject devices are powered by a Switch Model Power Supply (SMPS) that has a regulated output voltage of 5 VDC.

### ATEX Warnings and Conditions of Safe Usage:

Power, Input, and Output (I/O) wiring must be in accordance with the authority having jurisdiction

- A** Warning - Explosion Hazard - When in hazardous locations, turn off power before replacing or wiring modules.
- B** Warning - Explosion Hazard - Do not disconnect equipment unless power has been switched off or the area is known to be non-hazardous.
- C** These products are intended to be mounted in an IP54 enclosure. The devices shall provide external means to prevent the rated voltage being exceeded by transient disturbances of more than 40%. This device must be used only with ATEX certified backplanes.
- D** DO NOT OPEN WHEN ENERGIZED.

## China RoHS Hazardous Material Declaration Table

产品中有害物质的名称及含量  
Name and content of hazardous substances in product

部件名称 Component Name	有害物质					
	铅 Lead (Pb)	汞 Mercury (Hg)	镉 Cadmium (Cd)	六价铬 Hexavalent Chromium (Cr(VI))	多溴联苯 Polybrominated Biphenyls (PBB)	多溴二苯醚 Polybrominated Diphenyl Ethers (PBDE)
印刷电路板组件 Printed Circuit Board Assemblies	X	○	○	○	○	○
金属部件 Metal Components	X	○	○	○	○	○
电池 Battery	○	○	○	○	○	○
塑料部件 Plastic Components	○	○	○	○	○	○

本表格依据SJ/T 11364的规定编制。This table is made per guidance of SJ/T 11364  
X: 表示该有害物质至少在该部件的某一均质材料中的含量超出GB/T 26572规定的限量要求。  
(企业可在此处，根据实际情况对上表中打“X”的技术原因进行进一步说明。)

## Agency Approvals & Certifications

Please visit our website: [www.prosoft-technology.com](http://www.prosoft-technology.com)

# Contents

Your Feedback Please .....	2
MVI (Multi Vendor Interface) Modules .....	2
Warnings, Specification, and Certifications .....	3
<b>1 Preparing the MVI69E-LDM Module</b> .....	<b>8</b>
1.1 MVI69E-LDM Introduction .....	8
1.2 Specifications .....	9
1.3 System Requirements .....	10
1.4 Package Contents .....	10
1.5 Jumper Locations and Settings .....	11
1.5.1 Setup Jumper .....	12
1.5.2 Port 1 and Port 2 Jumpers .....	12
1.6 Installing and Connecting the Module .....	12
1.6.1 Installing the Module in the Chassis .....	13
1.6.2 Making Configuration Port Connections .....	16
1.6.3 Enabling and Disabling the Console Port .....	19
1.7 Establishing Module Communications .....	23
1.8 Resetting the Module .....	26
1.9 Important Information Before Development .....	28
<b>2 Development Environment</b> .....	<b>30</b>
2.1 Setup .....	30
2.2 Changing Password .....	33
2.3 Starting Eclipse .....	35
2.3.1 Building a Project .....	35
2.3.2 Compiling and Linking .....	36
2.3.3 Downloading the Application with FTP .....	37
2.3.4 Creating an Application Image .....	37
2.3.5 Downloading the Image with Firmware Update .....	39
<b>3 Understanding the MVI69E-LDM API</b> .....	<b>41</b>
3.1 API Library .....	41
3.1.1 Header File .....	41
3.1.2 Sample Code .....	41
3.1.3 CompactLogix Tag Naming Conventions .....	42
3.2 MVI69E-LDM Development Tools .....	43
3.3 CIP API Architecture .....	43
3.4 Backplane Device Driver .....	44
<b>4 Sample Code</b> .....	<b>45</b>
4.1 Establishing a Console Connection .....	46
4.1.1 Physically Connect to the Module .....	46
4.1.2 Configuring Serial Communication .....	46
4.1.3 Setting Up ControlLogix 5000 .....	47

4.2	Sample Tutorials .....	48
4.2.1	Ethernet Sample .....	48
4.2.2	Serial Sample.....	51
4.2.3	LED Sample.....	52
4.2.4	Backplane Sample .....	53
4.3	Application Tutorials .....	54
4.3.1	Ethernet Application.....	54
4.3.2	Serial Application .....	60
<b>5</b>	<b>API Functions</b> .....	<b>69</b>
5.1	CIP API Initialization Functions.....	69
	MVI69_Open .....	69
	MVI69_OpenNB .....	70
	MVI69_Close .....	71
	MVI69_GetIOConfig .....	72
	MVI69_SetIOConfig .....	73
5.2	Direct I/O Access .....	74
	MVI69_ReadOutputImage.....	74
	MVI69_WriteInputImage.....	75
5.3	Messaging.....	76
	MVI69_GetMsgRequestFromBp .....	76
	MVI69_SendMsgResponseToBp .....	78
5.4	Synchronization .....	80
	MVI69_WaitForInputScan .....	80
	MVI69_WaitForOutputScan .....	81
5.5	Serial Ports .....	82
	MVI69_GetSerialConfig.....	82
	MVI69_SetSerialConfig .....	84
5.6	Miscellaneous Functions .....	85
	MVI69_GetVersionInfo .....	85
	MVI69_GetModuleInfo .....	86
	MVI69_SetModuleInfo.....	87
	MVI69_GetScanMode .....	88
	MVI69_GetScanCounter .....	89
	MVI69_SetLED .....	90
	MVI69_GetSetupJumper.....	91
<b>6</b>	<b>Cable Connections</b> .....	<b>92</b>
6.1	RS-232 Configuration/Debug Port .....	92
6.2	RS-232 Application Port(s) .....	93
6.2.1	RS-232: Modem Connection (Hardware Handshaking Required) .....	93
6.2.2	RS-232: Null Modem Connection (Hardware Handshaking).....	94
6.2.3	RS-232: Null Modem Connection (No Hardware Handshaking) .....	94
6.3	RS-422.....	95
6.4	RS-485 Application Port(s) .....	95
6.4.1	RS-485 and RS-422 Tip .....	96
6.5	DB9 to RJ45 Adaptor (Cable 14) .....	96
<b>7</b>	<b>Open Source Licensing</b> .....	<b>97</b>
7.1	GNU Public License.....	98

---

7.2	Eclipse Public License.....	111
7.3	Python Public License .....	115
7.4	GCC Public License .....	120
<b>8</b>	<b>Support, Service &amp; Warranty</b>	<b>122</b>

---

8.1	Contacting Technical Support .....	122
8.2	Warranty Information .....	122

---

<b>9</b>	<b>Glossary of Terms</b>	<b>123</b>
----------	--------------------------	------------

---

# 1 Preparing the MVI69E-LDM Module

## 1.1 MVI69E-LDM Introduction

The MVI69E-LDM module is a CompactLogix backplane-compatible module that allows Rockwell Automation CompactLogix processors to interface with relatively any Ethernet or Serial device. With the supplied development tools and example applications, you are the developer that controls exactly what this module can and cannot do.

ProSoft Technology's Linux Development modules make it possible for you to easily develop and deploy C/C++ applications that interface with Bar Code Scanners, Legacy ASCII protocols, Terminal Port Emulation, Printer Drivers (Alarm/Status printer), or any other device requiring custom or proprietary Ethernet and Serial communications.

This document provides the information you need to develop application programs for the MVI69E-LDM module.

This document assumes you are familiar with software development in the Linux environment using the C/C++ programming languages. This document also assumes that you are familiar with Rockwell Automation programmable controllers and the CompactLogix platform.

You should be familiar with the following terms:

Term	Description
API	Application Programming Interface
Backplane	Refers to the electrical interface or bus to which modules connect when inserted into the rack. The MVI69E-LDM communicates with the control processor(s) through the CompactLogix backplane.
CIP	Control and Information Protocol. This is the messaging protocol used for communications over the CompactLogix backplane.
Connection	A logical binding between two objects. A connection allows more efficient use of bandwidth because the messaging path is not included after the connection is established.
Consumer	A destination for data.
Library	Refers to the library file (DLL) that contains the API functions. The library must be linked with the developer's application code to create the final executable program.
Originator	A client that establishes a connection path to a target.
Producer	A source of data.
Target	The end-node to which a connection is established by an originator.



## 1.2 Specifications

### CPU, Memory, and OS

- **CPU:** 400MHz ARM9 G20
- **Operating System:** Linux (kernel 2.6.22)
- **Linux Distribution:** BusyBox
- **System Memory:** 64MB SDRAM
- **Flash Memory:** 256MB NAND Flash

### General

- **Backplane Current Load:** 500 mA @ 5 VDC; 3mA @ 24 VDC
- **Operating Temperature:** 0 to 60°C (32 to 140°F)
- **Storage Temperature:** -40 to 85°C (-40 to 185°F)
- **Shock:** 30g non-operational; 15g non-operational; Vibration: 5 g from 10 to 150 Hz
- **Relative Humidity:** 5% to 95% (without condensation)
- **LED Indicators:** ETH - Application driven, P1 Application Driven, P2 Application driven, CFG - Application driven, BP - Application driven, OK - Application driven

### Ethernet Ports

- 1 Ethernet port
- 10/100 Mbps
- RJ45 connector
- Link and Activity indicators
- Auto-sensing crossover cable detection

### Serial Ports

- Full hardware handshaking control provides radio, modem, and multi-drop support.
- Serial Application ports: RJ45 (DB-9M with supplied adapter cable)
- Configurable RS-232 hardware handshaking
- 500V Optical isolation from backplane
- RS-232, RS-422, RS-485 (software configurable by the end user)
- Rx (Receive) and Tx (Transmit) LEDs, each port

### 1.3 System Requirements

The MVI69E-LDM module requires the following hardware and software components:

- Rockwell Automation CompactLogix processor (firmware version 18 or greater depending on processor type) with compatible power supply and one free slot in the rack for the module. The module requires 5 VDC power
- Rockwell Automation RSLogix 5000 software
- Rockwell Automation RSLinx communication software version 2.51 or greater
- Pentium II 450 MHz minimum. Pentium III 733 MHz or greater recommended
- Supported operating systems:
  - Microsoft Windows 10
  - Microsoft Windows 7 Professional (32-or 64-bit)
  - Microsoft Windows XP Professional with Service Pack 1 or 2
  - Microsoft Windows Vista
  - Microsoft Windows 2000 Professional with Service Pack 1, 2, or 3
  - Microsoft Windows Server 2003
- 128 MB RAM (minimum), 256 MB of RAM recommended
- 100 MB of free hard disk space (or more based on application requirements)
- 256-color VGA graphics adapter, 800 x 600 minimum resolution (True Color 1024 x 768 recommended)

**Note:** The Hardware and Operating System requirements in this list are the minimum recommended to install and run software provided by ProSoft Technology. Other third party applications may have different requirements. Refer to the documentation for any third party applications.

### 1.4 Package Contents

Your MVI69E-LDM package includes:

- RJ45 to DB-9M cables for each serial port
- (2) DB9 to screw terminal adapter
- Null Modem Cable

You can download all documentation, sample code, and sample ladder logic from our website for free ([www.prosoft-technology.com/ldmdevkit](http://www.prosoft-technology.com/ldmdevkit)).

If any of these components are missing, please contact ProSoft Technology Support.

#### Not Shipped with Unit

- LDMdevKit - Linux Development Module Development Kit (Available for purchase from ProSoft Technology and must be ordered separately.)

## 1.5 Jumper Locations and Settings

Each module has three jumpers:

- Setup
- Port 1
- Port 2

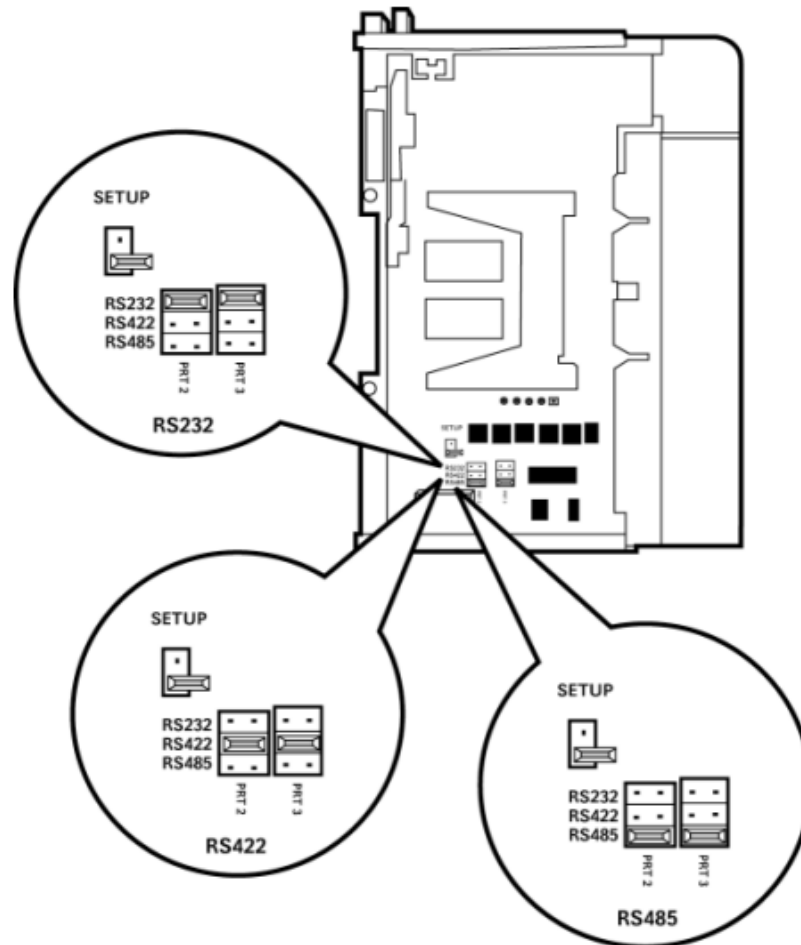

### 1.5.1 Setup Jumper

The Setup Jumper acts as a write protection for the module's firmware. In "write-protected" mode, the setup pins are not connected which prevents the module's firmware from being overwritten.

The module is shipped with the Setup Jumper OFF. If you need to update the firmware or run a module rescue (recovery), apply the setup shunt over both pins.

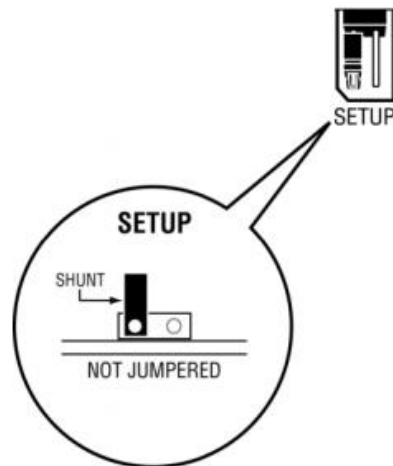

### 1.5.2 Port 1 and Port 2 Jumpers

These jumpers, located at the bottom of the module, aid in configuring the port settings to RS-232, RS-422, or RS-485. The "RS-232", "RS-485", and "RS-422" labels are there for convenience. The jumpers simply send a high/low signal when jumped or not jumped. The jumper configuration is read by the API, and the application code must change the appropriate port settings to the required mode (232, 485, 422).

## 1.6 Installing and Connecting the Module

If you have not already done so, please install and configure your CompactLogix processor and power supply. Refer to the Rockwell Automation product documentation for installation instructions.

**Warning:** You must follow all safety instructions when installing this or any other electronic devices. Failure to follow safety procedures could result in damage to hardware or data, or even serious injury or death to personnel. Refer to the documentation for each device you plan to connect to verify that suitable safety procedures are in place before installing or servicing this device.

After verifying proper jumper placement, insert the module into the CompactLogix chassis. Use the same technique recommended by Rockwell Automation to remove and install CompactLogix modules.

### 1.6.1 Installing the Module in the Chassis

You can install or remove CompactLogix system components while chassis power is applied and the system is operating. However, please note the following warning.

**Warning:** When you insert or remove the module while backplane power is on, an electrical arc can cause personal injury or property damage by sending an erroneous signal to your system's actuators. This can cause unintended machine motion or loss of process control. Electrical arcs may also cause an explosion they occur in a hazardous environment. Verify that power is removed, or that the area is non-hazardous before proceeding. Repeated electrical arcing causes excessive wear to contacts on both the module and its mating connector. Worn contacts may create electrical resistance that can affect module operation.

- 1 Align the module using the upper and lower tongue-and-groove slots with the adjacent module and slide forward in the direction of the arrow.

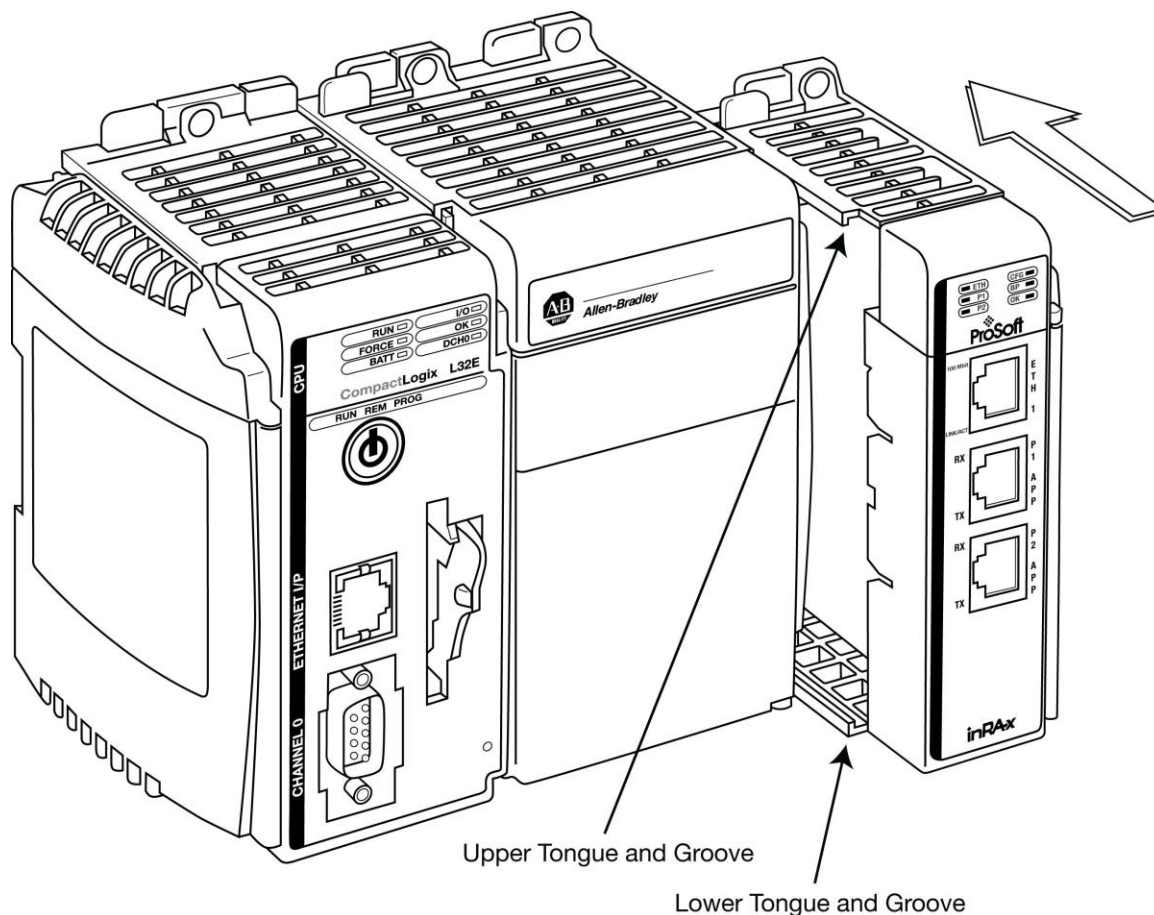

- 2 Move the module back along the tongue-and-groove slots until the bus connectors on the MVI69E module and the adjacent module line up with each other. Push the module's bus lever back slightly to clear the positioning tab and move it firmly to the left until it clicks. Ensure that it is locked firmly into place.

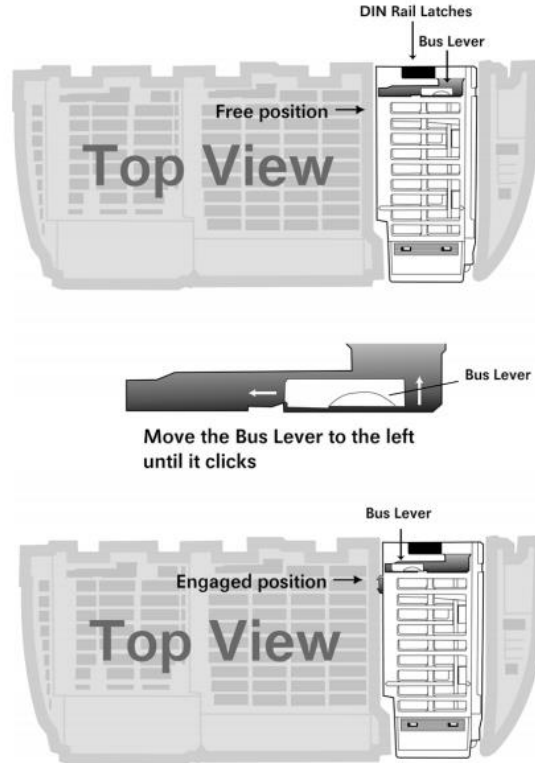

- 3 Close all DIN-rail latches.

- 4 Press the DIN-rail mounting area of the controller against the DIN-rail. The latches momentarily open and lock into place.

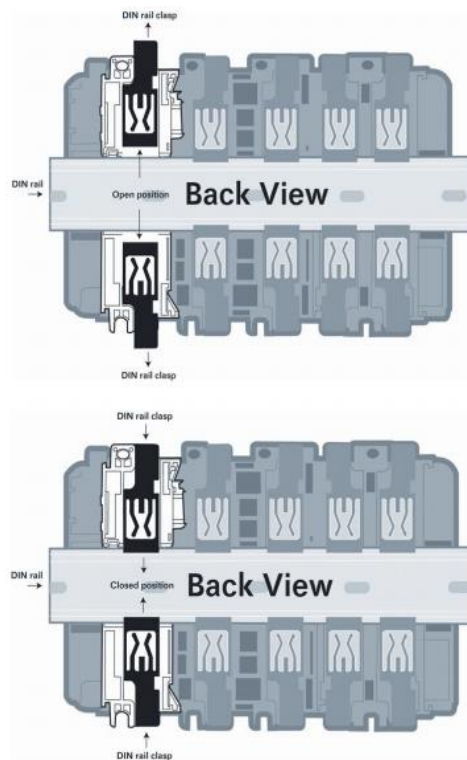

Module inserted.

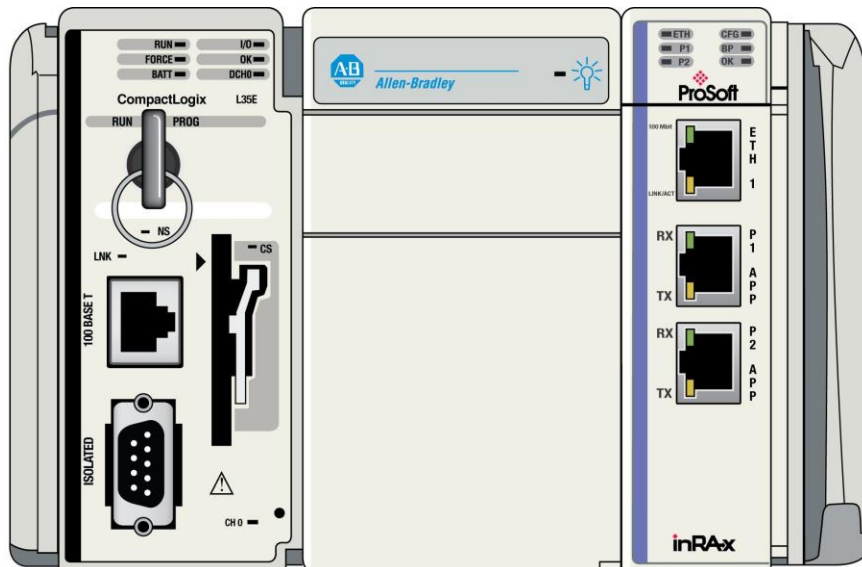

## 1.6.2 Making Configuration Port Connections

You can communicate with the module via RS-232 through the Console or through the Ethernet port using Telnet.

### RS-232 Console

You access the Console through Serial Port 1. As a default, the RS-232 Console port is enabled. You can disable or enable this port. Refer to *Enabling and Disabling the Console Port* in the next section.

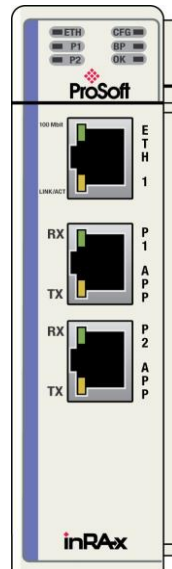

- 1 Connect the RJ45 end of an RJ45 - DB9m cable (*Cable 14*) to the Serial Port 1 of the module.
- 2 Connect one end of the Null Modem Cable (*Cable 15*) to the DB9m end Cable 14.
- 3 Connect the other end of Cable 15 (*null modem cable*) to a serial port on your PC or laptop.

### Ethernet Port

- 1 The module contains a Telnet client which you can access through Ethernet Port 1 (Eth 1) as shown.
- 2 Connect an Ethernet RJ45 cable to the Eth 1 port of the module and the other end to the Ethernet network switch.







### 1.6.3 Enabling and Disabling the Console Port

Establish a connection to the module. This example uses PuTTY.

- 1 Open PuTTY.

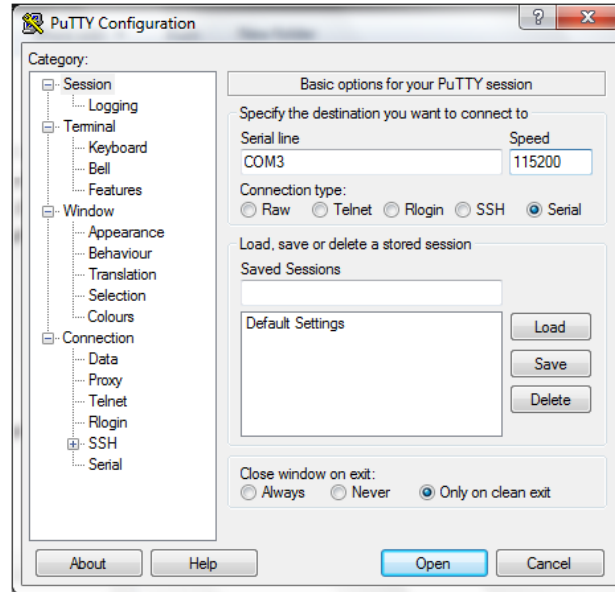

- 2 Set **SPEED** to 115200.
- 3 Set the **SERIAL LINE** to the appropriate COM port.
- 4 Ensure that the **CONNECTION TYPE** is Serial.
- 5 Click **OPEN**. The PuTTY session opens.
- 6 Enter your login and password.  
MVI69E login: root  
Password: password

**Note:** After the first successful login, you will be prompted to change the password. Be sure to record the new password in a safe place for future reference.

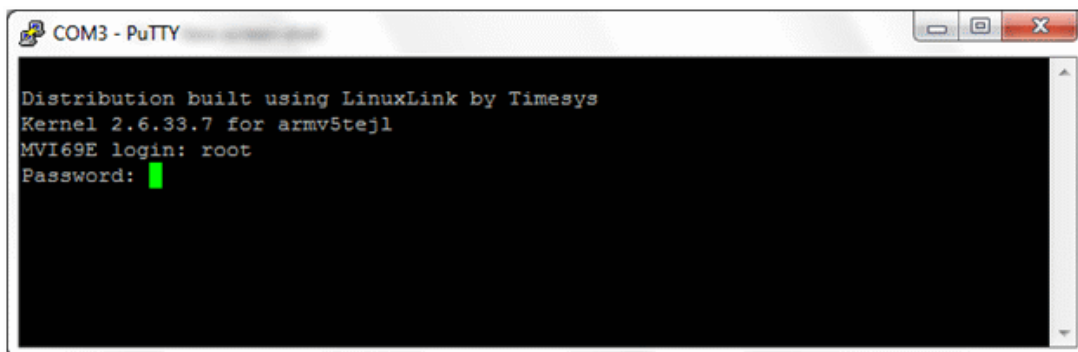

The following text appears:

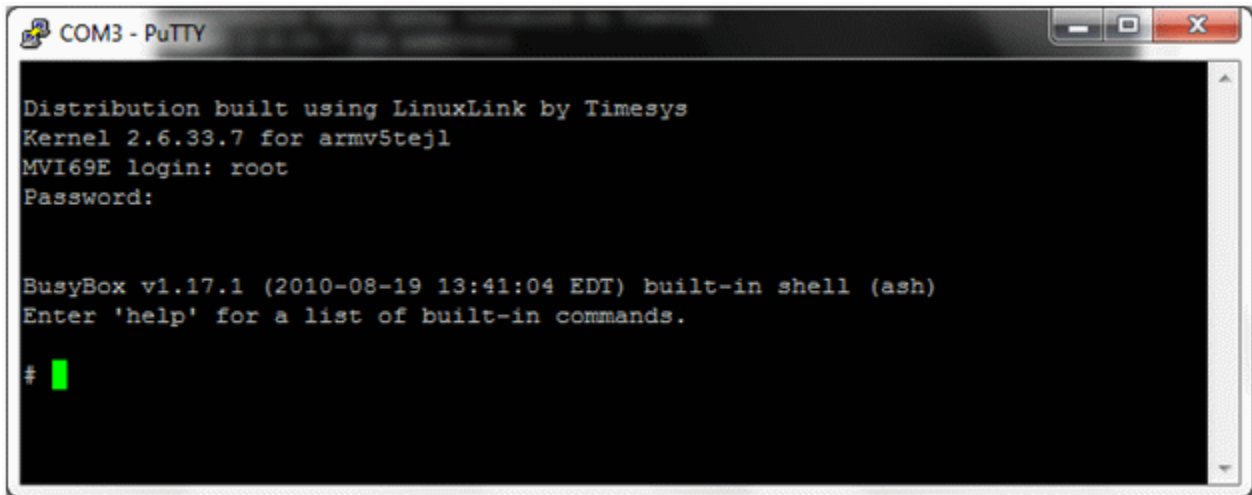

```
COM3 - PuTTY
Distribution built using LinuxLink by Timesys
Kernel 2.6.33.7 for armv5tej1
MVI69E login: root
Password:

BusyBox v1.17.1 (2010-08-19 13:41:04 EDT) built-in shell (ash)
Enter 'help' for a list of built-in commands.

#
```

- 7 Change to the `/etc` directory. Type:  
`cd /etc`

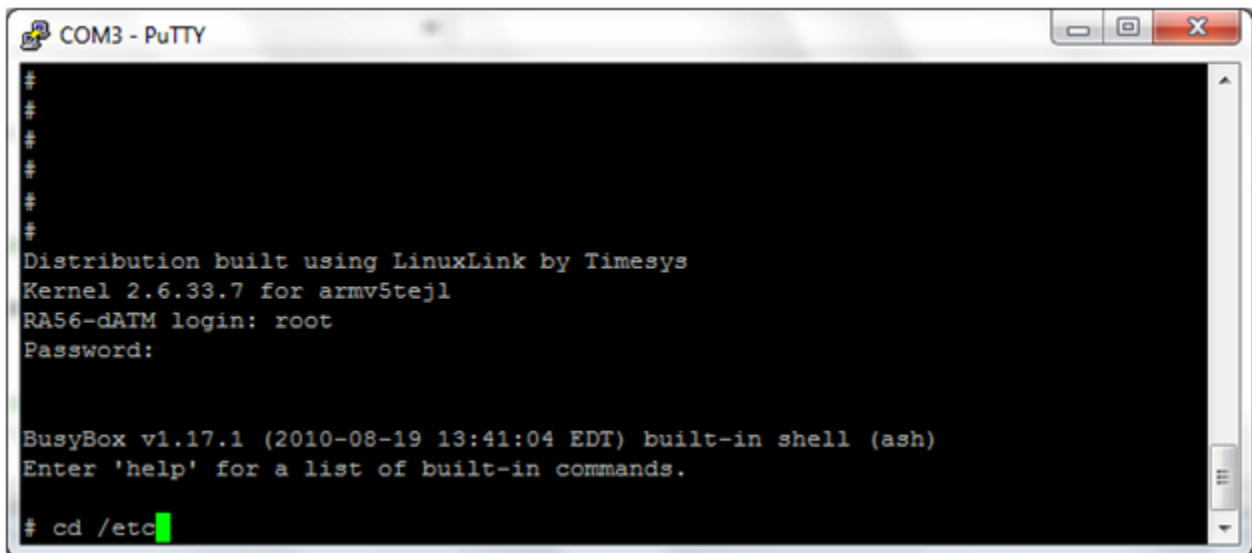

```
COM3 - PuTTY
#
#
#
#
#
#
Distribution built using LinuxLink by Timesys
Kernel 2.6.33.7 for armv5tej1
RA56-dATM login: root
Password:

BusyBox v1.17.1 (2010-08-19 13:41:04 EDT) built-in shell (ash)
Enter 'help' for a list of built-in commands.

# cd /etc
```

8 Type `ls`. The following appears:

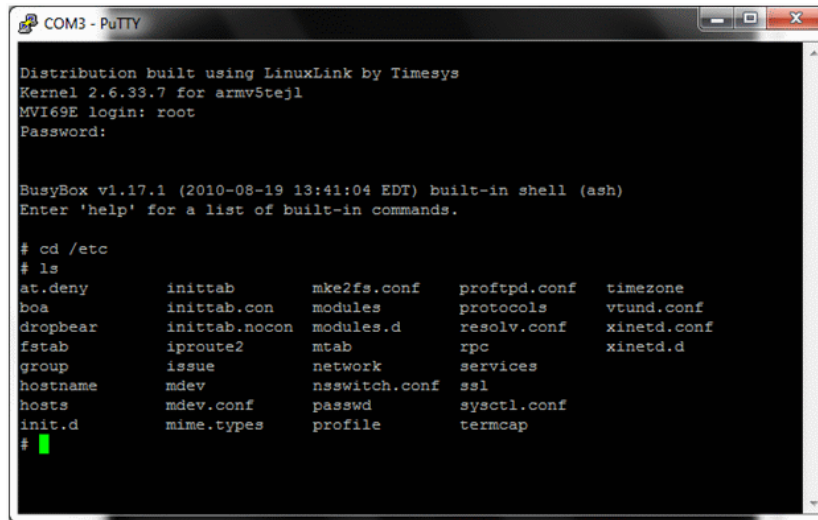

```
COM3 - PuTTY
Distribution built using LinuxLink by Timesys
Kernel 2.6.33.7 for armv5tej1
MVI69E login: root
Password:

BusyBox v1.17.1 (2010-08-19 13:41:04 EDT) built-in shell (ash)
Enter 'help' for a list of built-in commands.

# cd /etc
# ls
at.deny      inittab      mke2fs.conf  proftpd.conf  timezone
boa          inittab.con  modules      protocols      vtund.conf
dropbear    inittab.nocon modules.d     resolv.conf   xinetd.conf
fstab       iproute2    mtab         rpc            xinetd.d
group       issue       network      services
hostname    mdev        nsswitch.conf ssl
hosts       mdev.conf   passwd       sysctl.conf
init.d      mime.types  profile      termcap
#
```

**To enable the console port:**

The `inittab.con` file configures the console.

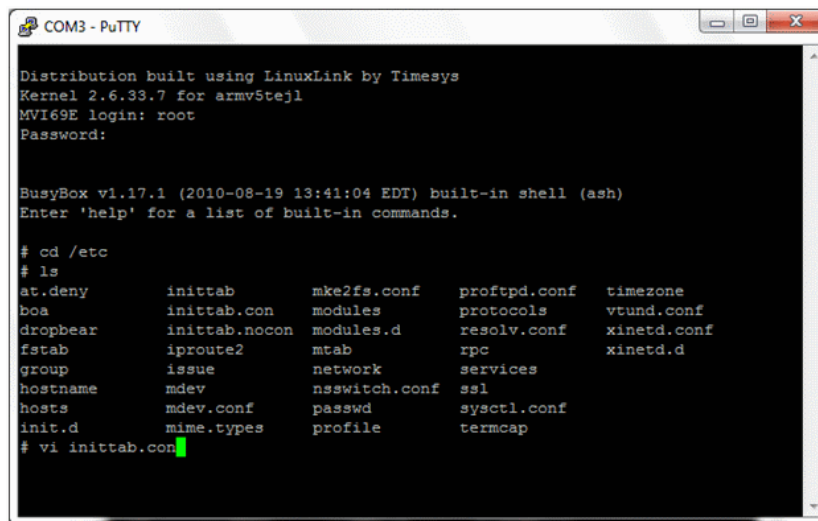

```
COM3 - PuTTY
Distribution built using LinuxLink by Timesys
Kernel 2.6.33.7 for armv5tej1
MVI69E login: root
Password:

BusyBox v1.17.1 (2010-08-19 13:41:04 EDT) built-in shell (ash)
Enter 'help' for a list of built-in commands.

# cd /etc
# ls
at.deny      inittab      mke2fs.conf  proftpd.conf  timezone
boa          inittab.con  modules      protocols      vtund.conf
dropbear    inittab.nocon modules.d     resolv.conf   xinetd.conf
fstab       iproute2    mtab         rpc            xinetd.d
group       issue       network      services
hostname    mdev        nsswitch.conf ssl
hosts       mdev.conf   passwd       sysctl.conf
init.d      mime.types  profile      termcap
# vi inittab.con
```

- 1 Open the file in the vi editor. Type  
`vi inittab.con`

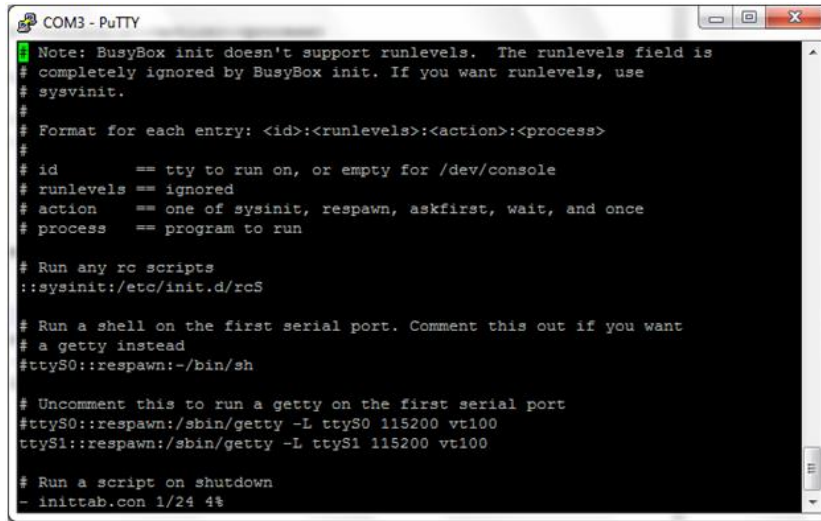

```
COM3 - PuTTY
Note: BusyBox init doesn't support runlevels. The runlevels field is
# completely ignored by BusyBox init. If you want runlevels, use
# sysvinit.
#
# Format for each entry: <id>:<runlevels>:<action>:<process>
#
# id      == tty to run on, or empty for /dev/console
# runlevels == ignored
# action  == one of sysinit, respawn, askfirst, wait, and once
# process == program to run

# Run any rc scripts
::sysinit:/etc/init.d/rcS

# Run a shell on the first serial port. Comment this out if you want
# a getty instead
#ttyS0:respawn:/bin/sh

# Uncomment this to run a getty on the first serial port
#ttyS0:respawn:/sbin/getty -L ttyS0 115200 vt100
ttyS1:respawn:/sbin/getty -L ttyS1 115200 vt100

# Run a script on shutdown
-inittab.con 1/24 4$
```

- 2 Copy `inittab.con` file to the `inittab` file. Type  
`cp -f inittab.con inittab`
- 3 Save the file and reboot the module.

**To disable the console:**

- 1 Copy `inittab.nocon` file to the `inittab` file.
- 2 Save the file and reboot the module.

## 1.7 Establishing Module Communications

Ensure that the module is firmly seated in the rack and that the cables connected to the module are secure. Ensure that power is applied.

**Note:** If you require information on cables and port pinouts, please refer to the section entitled *Cable Connections* (page 92) at the end of the document.

### RS-232 Console

If you are connected to Serial Port 1 (P1), establish communications with the module using the following procedure.

**Note:** The following procedure uses PuTTY to establish communications. You can use a different communication program.

#### 1 Open PuTTY.

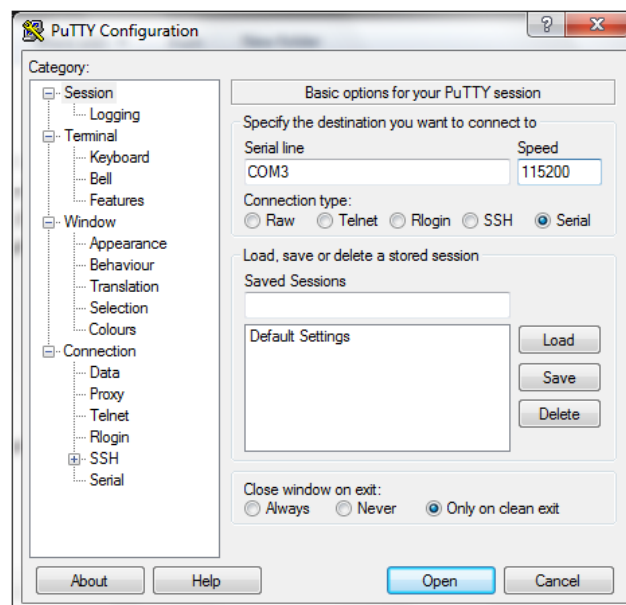

- 2 Set **SPEED** to 115200.
- 3 Set **SERIAL LINE** to the appropriate COM port.
- 4 Ensure that **CONNECTION TYPE** is set to Serial.
- 5 Click **OPEN** to open the PuTTY session.
- 6 Enter your login and password:  
MVI69E login: `root`  
Password: `password`

**Note:** After the first successful login, you will be prompted to change the password. Be sure to record the new password in a safe place for future reference.

## Ethernet (Telnet)

You can communicate with the module through Ethernet Port 1 (Eth 1) using Telnet.

The Ethernet Port (Eth 1) on the module is programmed with eth0 set to IP 192.168.0.250 and a Subnet Mask of 255.255.255.0. In order for your PC or laptop to talk to the module, your PC or Laptop must be on the same subnet as the module. This means that you must temporarily change the IP address and subnet mask on your PC or laptop to match that of the module. You can then change the module's IP address to match your needs. Follow these steps or see <http://windows.microsoft.com/en-us/windows/change-tcp-ip-settings#1TC=windows-7> <http://windows.microsoft.com/en-us/windows/change-tcp-ip-settings#1TC=windows-7>.

- 1 Change the IP address of your PC or Laptop so it matches the subnet of the module. The following steps are for Windows 7.
  - a Change your IP address through the router. Consult your router documentation for more information.
  - b Change your IP address through Windows Network Connections. Click **START > CONTROL PANEL > NETWORK AND SHARING CENTER**.
  - c Click the **CONNECTION** link for the connection you want to change and choose **PROPERTIES**.
  - d On the Local Area Connection Properties dialog, select the connection you want to change (Internet Protocol Version 6 or Internet Protocol Version 4), and then click **PROPERTIES**.
  - e In the Internet Protocol Version 4 or 6 Properties dialog, click **USE THE FOLLOWING IP ADDRESS**.
  - f Type in the IP address settings for the **IP ADDRESS**, **SUBNET MASK**, and **DEFAULT GATEWAY**.
  - g Click **OK** to accept the changes and then close each of the dialog boxes.
- 2 Ensure that an Ethernet cable is connected to Ethernet Port 1 (Eth 1) of the module, and the other end to the same Ethernet switch as your PC.



- 3 Use a program such as PuTTY to Telnet into the module.

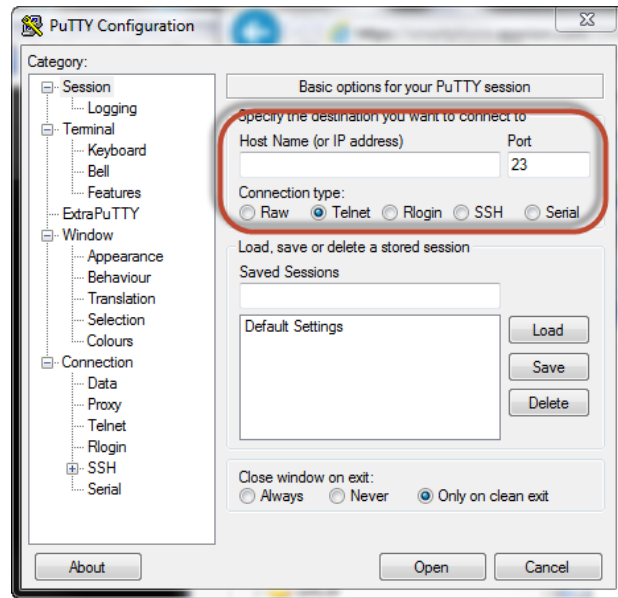

- 4 Select Telnet as the **CONNECTION TYPE**.
- 5 Enter the **IP ADDRESS** (192.168.0.250).
- 6 Port 23 should appear as the **PORT** number.
- 7 Click **OPEN** to establish a connection.
- 8 Log into the module.

There are two methods you can use to change the module's IP address. One is temporary for use in cases where you want to change the address long enough to make a quick change. The other is more permanent so that the module is already programmed and is ready for full deployment.

### Temporary IP Address Change

At the Linux prompt, type:

```
ifconfig eth0 x.x.x.x (This changes the IP address of the Ethernet Eth 1 port.)
```

### Permanent IP Address Change

- 1 At the Linux prompt, change to the /etc/network directory. Type:

```
cd ../etc/network
```

- 2 Open the `interfaces` file in the vi editor. Type:

```
vi interfaces
```

This shows the contents of the file:

```
iface eth0 inet static
    address 192.168.0.250
    network 192.168.0.0
    netmask 255.255.255.0
    broadcast 192.168.0.255
# gateway 192.168.0.1
```

- 3 Using the vi editor, edit the file to change the address.
- 4 Save the file.  
For help on using the vi editor to write and save the file, refer to <http://www.lagmonster.org/docs/vi.html>
- 5 Change the IP address of your PC back to the original IP address and subnet.
- 6 Telnet to the new IP Address of the module.

## 1.8 Resetting the Module

In the event that it becomes necessary to revert the MVI69E-LDM module back to its initial out-of-the-box state, there are a number of methods you can use depending on the condition of the module.

The Rescue process re-installs all of the Operation System commands and configurations to their original defaults. The files deleted during the rescue process are the startup scripts in the /etc/init.d path since extra scripts in this path are automatically executed by the operating system on startup and may cause problems. All other files may be overwritten to the initial state of the device. Extra files are not deleted.

If the web pages and services for the module have been altered, it may not be possible to use the web-based rescue.

### **To connect to the module over Ethernet:**

- 1 Place the onboard setup jumper to the installed state. See *Setup Jumper - MVI69E*.
- 2 If you know the the IP address, change the network mask and IP of the connected PC to compatible values.  
For example, if the MVI69E-LDM is configured with the default IP address (192.168.0.250) and network mask (255.255.255.0), the the PC should have the same IP4 network mask and an IP address in the 192.168.0.xxx subnet.  
Note that IP addresses must be unique on the network. If in doubt, create a physical network consisting of only the MVI69E-LDM and the PC.

If you do not know the IP address of the MVI69E-LDM module, you can establish communication through the serial configuration port, Port 1 (upper port).

- 1 Use Telnet or a similar terminal program to communicate with the module. The default settings are 115,200 baud, 8 data bits, 1 stop bit, No Parity, xon/xoff flow control.
- 2 Use the following username and password:  
Username: `root`  
Password: `password`

**Note:** After the first successful login, you will be prompted to change the password. Be sure to record the new password in a safe place for future reference.

- 3 From the shell prompt, run `ifconfig` to find the Ethernet IP address and network mask of device "eth0". Then follow the steps under *To connect to the module over Ethernet* (above).

**To use web-based rescue:**

The web page for the MVI69E-LDM module contains a command on the left side of the page to reset the module.

- 1 Open the web page for the module by entering the IP address of the module in the address bar. If necessary, set your PC to an IP address and the same sub-network. See To connect to the module over Ethernet (above).
- 2 On the left-side of the page, under **FUNCTIONS**, click **RESCUE MODULE**. Follow the instructions to reset the module to its default state.

**Note:** Most loaded components are left intact by this operation so it may be necessary to make enough room on the module for the rescue to work. In addition, the Setup Jumper must be in place for the rescue to function properly.

**To use manual rescue:**

If the default web page is unavailable, a manual rescue may be required. Perform the following steps to manually return the module to its default state:

- 1 Establish a terminal session to the module using either the Serial or Ethernet port.
- 2 Ensure that the `/backup/systemrestore.tgz` file exists.
- 3 Run the following command to remove any startup scripts that may be interfering with the bootup process:  

```
rm -f /etc/init.d/*
```
- 4 Restore the configuration and executables using the following command:  

```
tar -xzf /backup/systemrestore.tgz -C /
```
- 5 If successful, reboot the module.

## 1.9 Important Information Before Development

When the MVI69E-LDM is initially installed in the backplane, the module runs a number of programs that are required in order not to fault the processor.

```
COM3 - PuTTY
PID USER      VSZ STAT COMMAND
  1 root        2140 S   init
  2 root         0 SW   [kthreadd]
  3 root         0 SW   [ksoftirqd/0]
  4 root         0 SW   [events/0]
  5 root         0 SW   [khelper]
  8 root         0 SW   [async/mgr]
 75 root         0 SW   [sync_supers]
 77 root         0 SW   [bdi-default]
 79 root         0 SW   [kblockd/0]
 99 root         0 SW   [rpciod/0]
106 root         0 SW   [kswapd0]
153 root         0 SW   [aio/0]
162 root         0 SW   [nfsiod]
280 root         0 SW   [mtdblockd]
312 root         0 SWN  [jffs2_gcd_mtd0]
357 root       28640 S   /psft/sample/Backplane_Sample
364 root       2136 S   /usr/sbin/dropbear
373 ftp        2752 S   proftpd: (accepting connections)
384 root       2140 S   telnetd
387 root       2144 S   -sh
388 root       1964 S   /usr/sbin/boa
813 root       2464 R   ps
#
```

Line 357, **/psft/sample/Backplane\_Sample** runs for the purpose of not faulting the processor. The module also contains a number of sample applications that will not run if backplane sample is also running. The samples affected are **enet\_application** and **serial\_application**.

You can kill the Backplane\_Sample script by typing:

```
kill 357
```

```
COM3 - PuTTY
# kill 357
# ps
PID USER      VSZ STAT COMMAND
  1 root        2140 S   init
  2 root         0 SW   [kthreadd]
  3 root         0 SW   [ksoftirqd/0]
  4 root         0 SW   [events/0]
  5 root         0 SW   [khelper]
  8 root         0 SW   [async/mgr]
 75 root         0 SW   [sync_supers]
 77 root         0 SW   [bdi-default]
 79 root         0 SW   [kblockd/0]
 99 root         0 SW   [rpciod/0]
106 root         0 SW   [kswapd0]
153 root         0 SW   [aio/0]
162 root         0 SW   [nfsiod]
280 root         0 SW   [mtdblockd]
312 root         0 SWN  [jffs2_gcd_mtd0]
364 root       2136 S   /usr/sbin/dropbear
373 ftp        2752 S   proftpd: (accepting connections)
384 root       2140 S   telnetd
387 root       2144 S   -sh
388 root       1964 S   /usr/sbin/boa
860 root       2464 R   ps
```

You can modify the **Backplane\_Sample** script from this location:

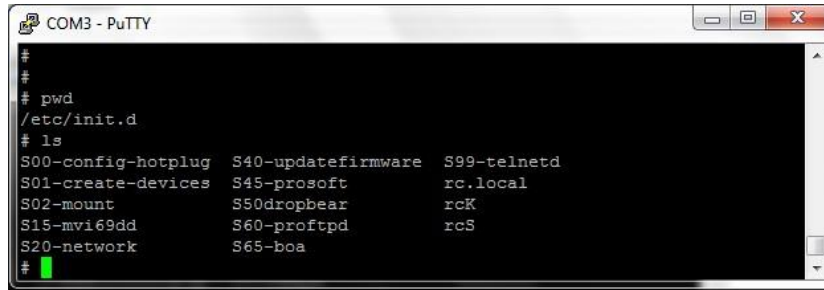

```
COM3 - PuTTY
#
#
# pwd
/etc/init.d
# ls
S00-config-hotplug  S40-updatefirmware  S99-telnetd
S01-create-devices  S45-prosoft         rc.local
S02-mount           S50dropbear         rcK
S15-mvi69dd         S60-proftpd         rcS
S20-network         S65-boa
```

The script that you want to modify is **S45-prosoft**.

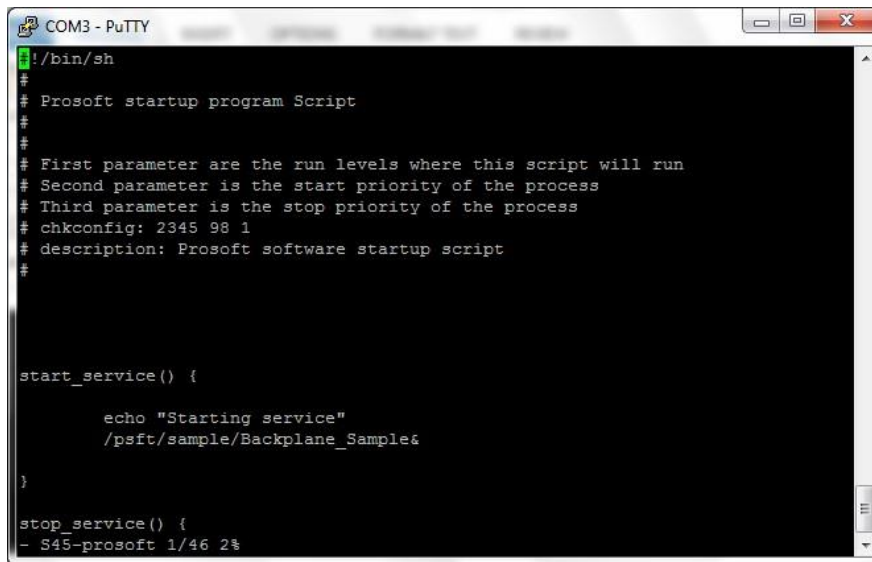

```
COM3 - PuTTY
~/bin/sh
#
# Prosoft startup program Script
#
# First parameter are the run levels where this script will run
# Second parameter is the start priority of the process
# Third parameter is the stop priority of the process
# chkconfig: 2345 98 1
# description: Prosoft software startup script
#
start_service() {
    echo "Starting service"
    /psft/sample/Backplane_Sample&
}
stop_service() {
- S45-prosoft 1/46 2%
```

You can see from this script that the **Backplane\_Sample** is configured to run at startup. Change this to suit your needs.

## 2 Development Environment

The MVI69E-LDM development tools run under Linux. In order to run these tools on a Windows-based machine, you must run a Virtual Machine that hosts the Linux Operating System.

VMware provides a virtual machine player used to host the Linux Operating System. You can find it at: <https://my.vmware.com/web/vmware/downloads>

### 2.1 Setup

The file `Debian6VM.zip` is part of the LDMdevKit package which you can download for free from the ProSoft Technology website: [www.prosoft-technology.com](http://www.prosoft-technology.com). You can also purchase the DVD (part number LDMdevKit) from ProSoft Technology.

- 1 Copy the `Debian6VM.zip` file to your PC in the VM Player image ico directory (`VMware\VMware Player\ico`).
- 2 Uncompress `Debian6VM.zip` into this directory.
- 3 Start the VM Player by double-clicking on its icon on the Windows desktop.
- 4 Click **OPEN A VIRTUAL MACHINE**.

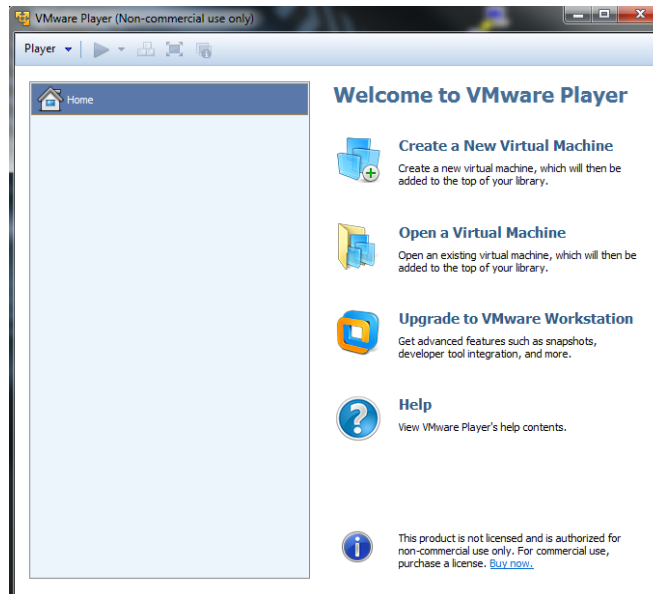

- 5 Navigate to the ico directory containing the `Debian6VM` file and click **DEBIAN6VM.VMX**. The image file icon appears in the left window.

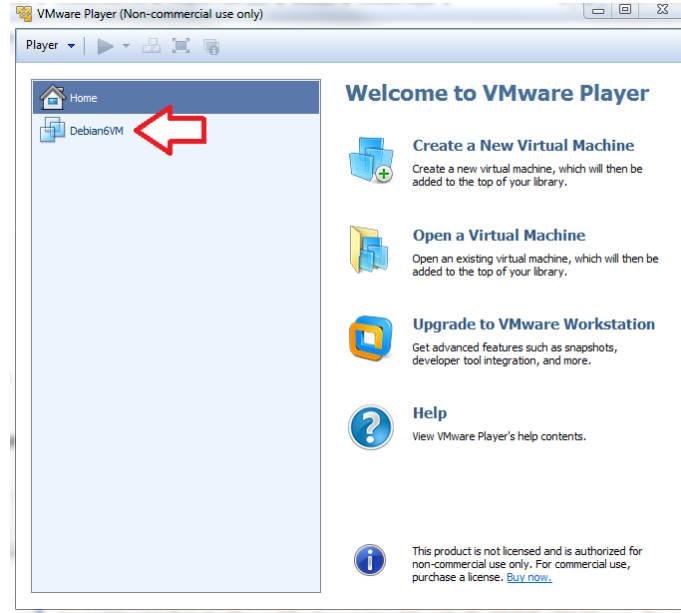

The following screen appears:

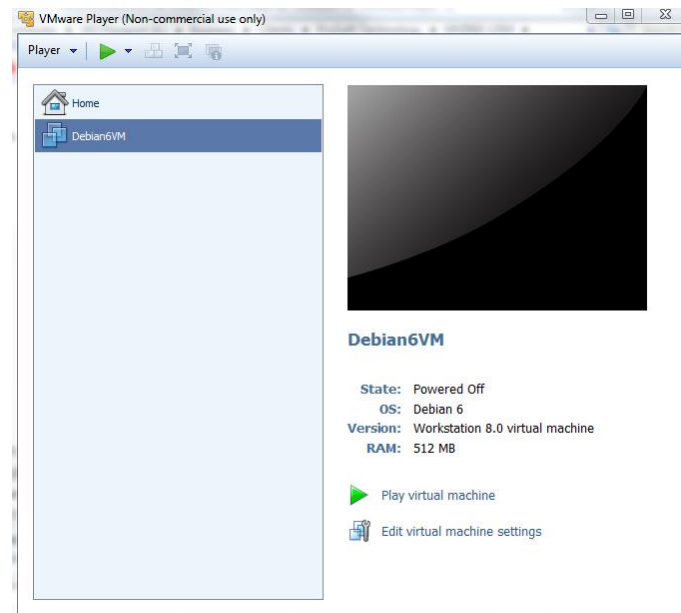

- 6 Click **PLAY VIRTUAL MACHINE**. A dialog appears asking if the virtual machine has been moved or copied. Click **I COPIED IT**.

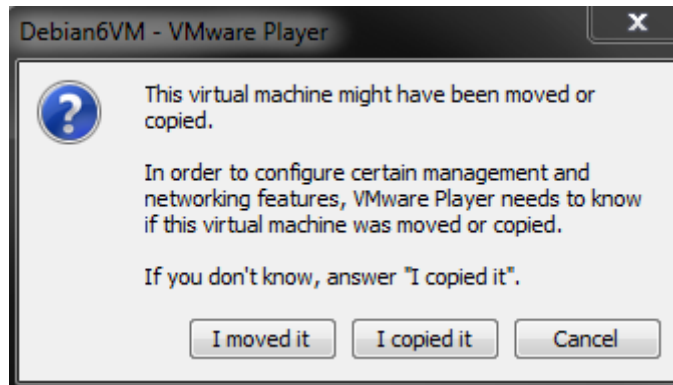

- 7 After the image loads, the VMware Player prompts you for a username and password.  
Username: `user`  
Password: `password`

**Note:** After the first successful login, you will be prompted to change the password. Be sure to record the new password in a safe place for future reference. Please see the next section Changing Password on page 33.

The home screen appears.

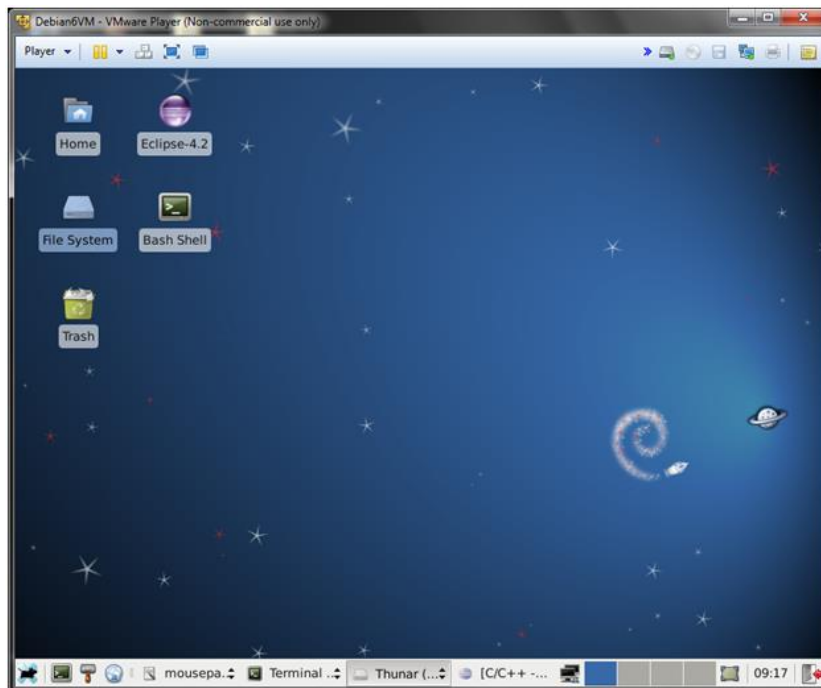



## 2.2 Changing Password

After the initial login to the VM, you will be prompted to change the password. Be sure to record the new password in a safe place for future reference.

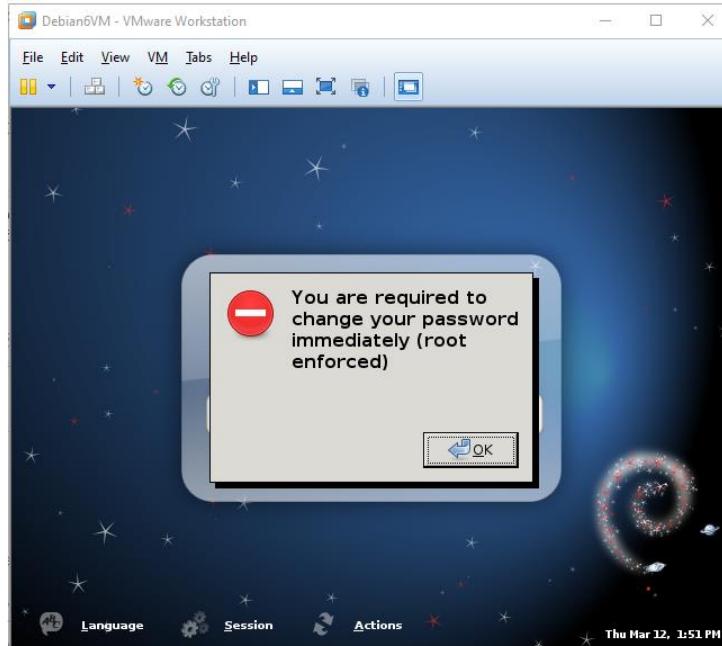

- 1 Enter the current (default) password: **password**.

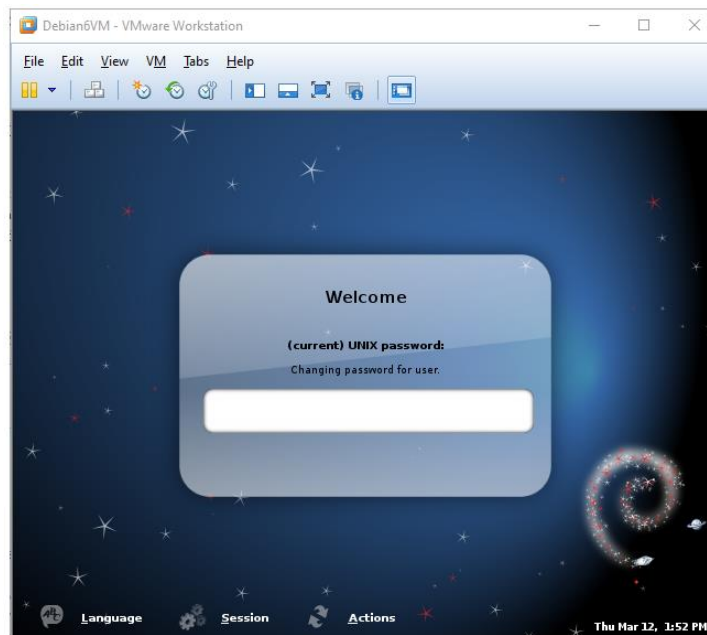

2 Enter the new password.

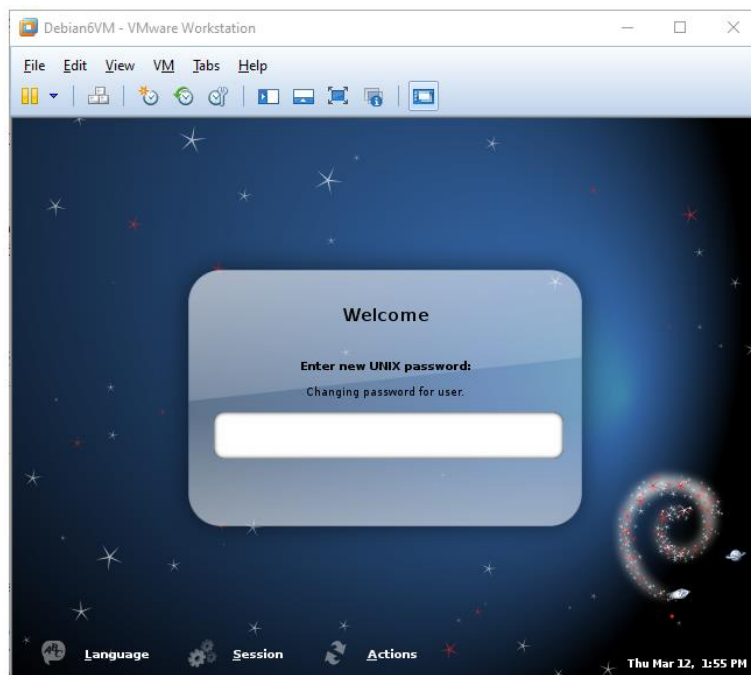

3 Confirm the new password.

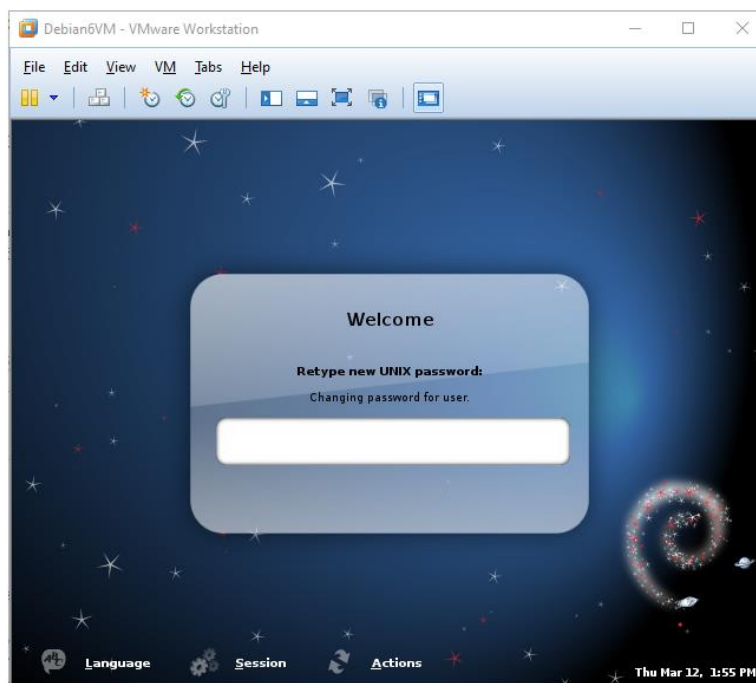

## 2.3 Starting Eclipse

Eclipse is an Integrated Development Environment (IDE) used in the Linux environment primarily to edit source code. Full documentation and downloads are available at: [www.eclipse.org](http://www.eclipse.org)

### ***To start Eclipse:***

- 1 Double-click the Eclipse icon on our Windows desktop.
- 2 When the Workspace Launcher appears, choose the default workspace (/home/user/workspace).

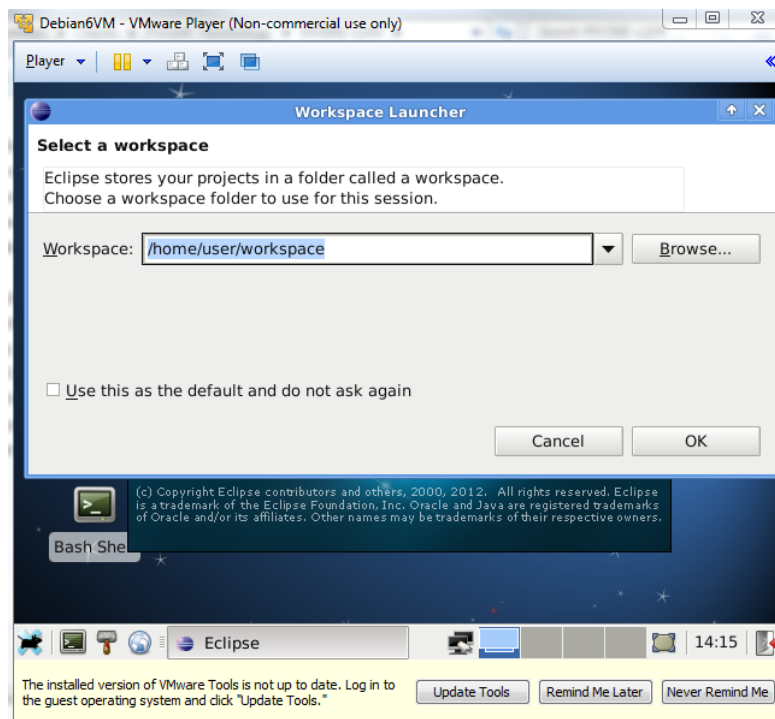

- 3 Click **OK**.

The default workspace is pre-populated with sample programs, makefiles, and scripts. Building one of the sample projects is the recommended way to become familiar with the environment and the build process.

### ***2.3.1 Building a Project***

Building and using a sample application consists of the following steps:

- 1 Compiling and linking your application.
- 2 Downloading the application. There are two ways you can do this:
  - Use FTP transfer to download the application.
  - Create a downloadable image, and then download the image to the target device (module).

### 2.3.2 Compiling and Linking

- 1 Start the Linux (Debian) virtual machine in the VM Player.
- 2 Open a Bash Shell window by clicking on the **BASH SHELL** icon on the main page.
- 3 Once in the shell, change the directory to one of the samples. In this case, change the directory to get to the LED\_sample program. Type:

```
cd /workspace/mvi69e-ldm/src/LDM/led_sample$
```

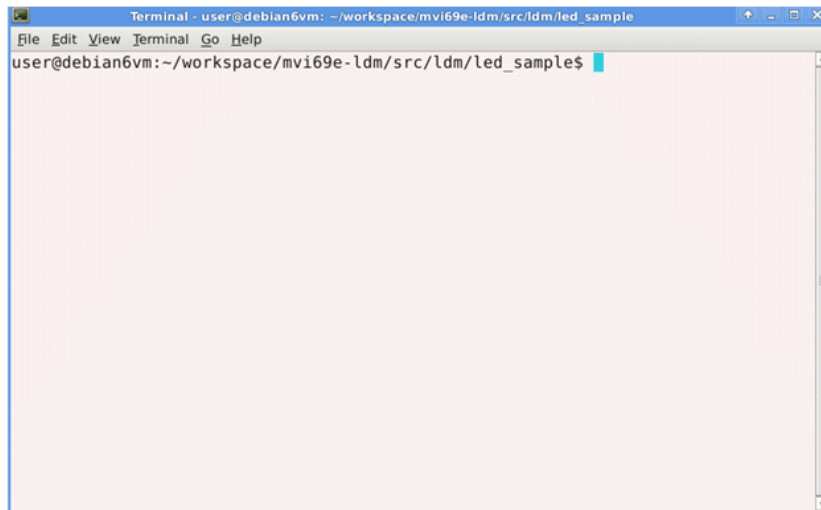

- 4 To recompile and link, simply type:

```
make
```

In this case, the executable is up to date and nothing needs to be done.

- 5 If the source is changed, the make utility detects the newer time on the source file and rebuilds the application. The following example uses the Touch utility to cause the date of a file (led\_sample.c) to be updated as if the file had been changed, and make is re-invoked. Make detects this change, recompiles and re-links the application.



### 2.3.3 Downloading the Application with FTP

To transfer the application using FTP Transfer, use any FTP transfer program such as FileZilla (<https://filezilla-project.org/>) from the Windows environment.

Use FileZilla to connect to the target by specifying the IP address of the MVI69E-LDM's IP. Download the application image to the desired directory on the LDM using the FTP transfer program.

Since Windows does not have the same detailed permissions as Linux, you must change the file permissions on the application once in the module. Use the command `chmod a+x filename` to add the execute attribute to the application.

You can also download the application by creating an image and using Firmware update. See *Creating an Application Image*.

### 2.3.4 Creating an Application Image

An image contains all of the application-specific components required for your application. This includes the executable(s), application-specific shared libraries, scripts, web pages, and data files. It does not contain the operating system or common components that are already on the target device.

The image is a compressed tar file of the application components. Once created, use the device's web page to download the firmware upgrade. The tar file name is specified in **IMAGE CONTENTS**. In the sample image, the firmware file is 'firmware/mvi69e-ldm.firmware revision date'. This firmware file is downloaded to the directory `/psfttmp` on the target device. Upon system restart, the system startup scripts unpack the tar file into the **psfttmp** directory. The script `/psfttmp/install` is executed to move the component files into their final destination.

A sample install file is included with the sample applications. The steps are:

- 1 Create all of the components that are part of the system. This mainly involves compiling and linking executables and shared libraries.
- 2 Create the install script.
- 3 Modify any web pages and data files that will be needed.
- 4 Last, update the install script.

#### **To create the Image Contents:**

Each component file to be included in the image is listed in the file `imagecontents` in the build directory structure for the specific application. This file contains header information about the image and a list of entries describing the files to be added to the image. The format of the entry is:

*Add source destination file permissions*

Where:

- The source file is the path to the file to be included.
- The destination file is the full path name of the file on the destination on the target device.
- The permissions are the Linux style permissions of the file on the destination.

For example, a line to add the LED\_Sample application looks like:

```
Add ../../src/ldm/led_sample/Release/Led_Sample /psft/sample/Led_Sample rwxrwxr-x
```

Since builds occur in `/home/usr/workspace/mvi69e-ldm/build/LDM`, source paths are relative to this directory to simplify moving to a new directory.

Follow the sample provided to create a complete image contents file.

### **To create the Install Script:**

Before creating the image, you must create and add an install script to the firmware package. As noted above, the firmware package is downloaded into the `/psfttmp` directory on the device. The install script copies the files in `/psfttmp` to their final destination on the target device. You can use the install script to make backups of the current directory contents before they are overwritten. The LDM sample install script in `build/LDM/scripts` illustrates how to do this.

### **To create the Image:**

- 1 In a Linux shell, change the directory to the `...build/LDM` directory.
- 2 Run python with the following command:

```
python createimage.py
```

The python script `createimage.py` reads and acts on the `imagecontents` file and then creates a new firmware image in the directory `.../build/LDM/firmware`.

**Note:** The script `build.sh` compiles and links all libs and executables and then invoke python to create the firmware image.

### 2.3.5 Downloading the Image with Firmware Update

- 1 Ensure that the Setup Jumper is on. See *Setup Jumper* in this document.
- 2 Navigate to the module homepage using a Web browser by entering the module's IP address.



- 3 Click **FIRMWARE UPGRADE**. The Update page opens.

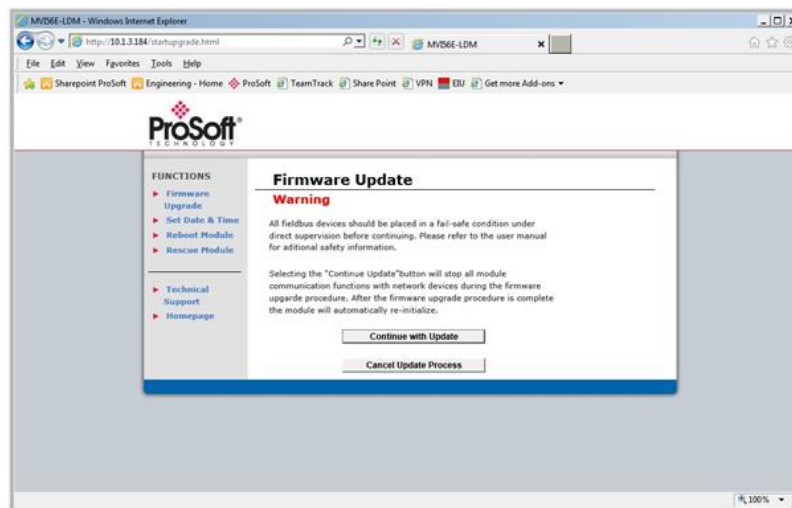

- 4 Click **CONTINUE WITH UPDATE**, and select the firmware file to be downloaded.

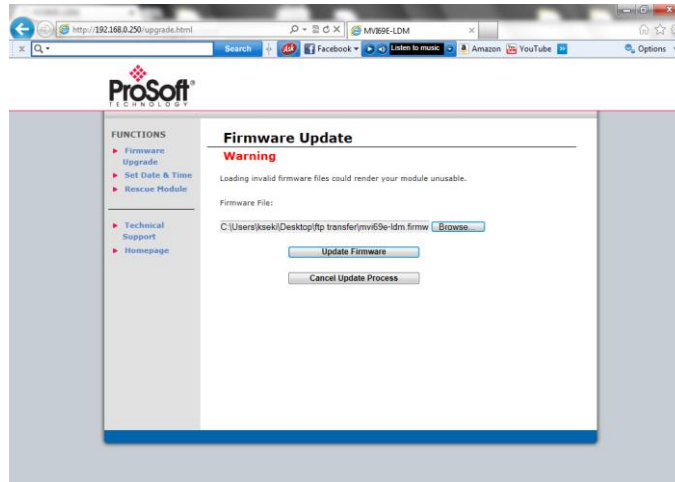

- 5 Click **UPDATE FIRMWARE** and wait for the module to reboot. During rebooting, the module expands the compressed file and runs the install script to move the component files to their final destination.

**Note:** The IP address reverts to the default after rebooting. This is a very common problem, so remember to reset the IP address to the correct value. See *Establishing Module Communication*.



## 3 Understanding the MVI69E-LDM API

The MVI69E LDM CPI API Suite allows software developers to access the CompactLogix backplane without requiring detailed knowledge of the module's hardware design. The MVI69E-LDM API Suite consists of three distinct components; the backplane device driver, the backplane interface engine, and the API library.

You can develop applications for the MVI69E-LDM module using industry-standard Linux programming tools and the CPI API library. This section provides general information pertaining to application development for the MVI69E-LDM module.

### 3.1 API Library

The API provides a library of function calls. The library supports any programming language that is compatible with the 'C' calling convention. The API library is a dynamic linked library that must be linked with the application to create the executable program>

**Note:** The following compiler versions are tested and known to be compatible with the MVI69E module API:  
CNU C/C++ V4.4.4 for ARM9

#### 3.1.1 Header File

A header file is provided along with the API library. This header file contains API function declarations, data structure definitions, and constant definitions. The header file is in standard 'C' format. Header files for the CIP API are `ocxbpapi.h` and `ocxtagdb.h`.

#### 3.1.2 Sample Code

The sample applications illustrate the usage of the API functions. Full source for the sample application is included, along with make files to build the sample programs.

### 3.1.3 CompactLogix Tag Naming Conventions

CompactLogix tags fall into two categories; controller tags and program tags.

**Controller Tags** have global scope. To access a controller scope tag, you only need to specify the tag controller name. For example:

TagName	Single tag
Array[11]	Single dimensioned array element
Array[1,3]	Two dimensional array element
Array[1, 2, 3]	Three dimensional array element
Structure.Element	Structure element
StructureArray[1].Element	Single element of an array of structures

**Program Tags** are tags declared in a program and scoped only within the program in which they are declared. To correctly address a Program Tag, you must specify the identifier "PROGRAM:" followed by the program name. A dot (.) separates the program name and the tag name.

PROGRAM:ProgramName.TagName

PROGRAM:MainProgram.TagName	Tag "TagName" in program called "MainProgram"
PROGRAM:MainProgram.Array[11]	An array element in program "MainProgram"
PROGRAM:MainProgram.Structure.Element	A Structure Element in program "MainProgram"

#### Rules

- A tag name can contain up to 40 characters.
- A tag name must start with a letter or underscore ("\_"). All other characters can be letters, numbers or underscores.
- Names cannot contain two contiguous underscore characters and cannot end in with an underscore.
- Letter case is not significant.
- The naming conventions are based on the IEC-1131 Rules for Identifiers.

For additional information on CompactLogix CPU tag addressing, please refer to the CompactLogix User Manual.

### 3.2 MVI69E-LDM Development Tools

An application that is developed for the MVI69E-LDM module must be executed from the module's Flash ROM disk. Tools are provided with the API to build the disk image and download it to the module's Config/Debug port. See *Building a Project* (page 35).

### 3.3 CIP API Architecture

The CIP API communicates with the CompactLogix modules through the backplane device driver. The following illustration shows the relationship between the module application, CIP API, and the backplane driver:

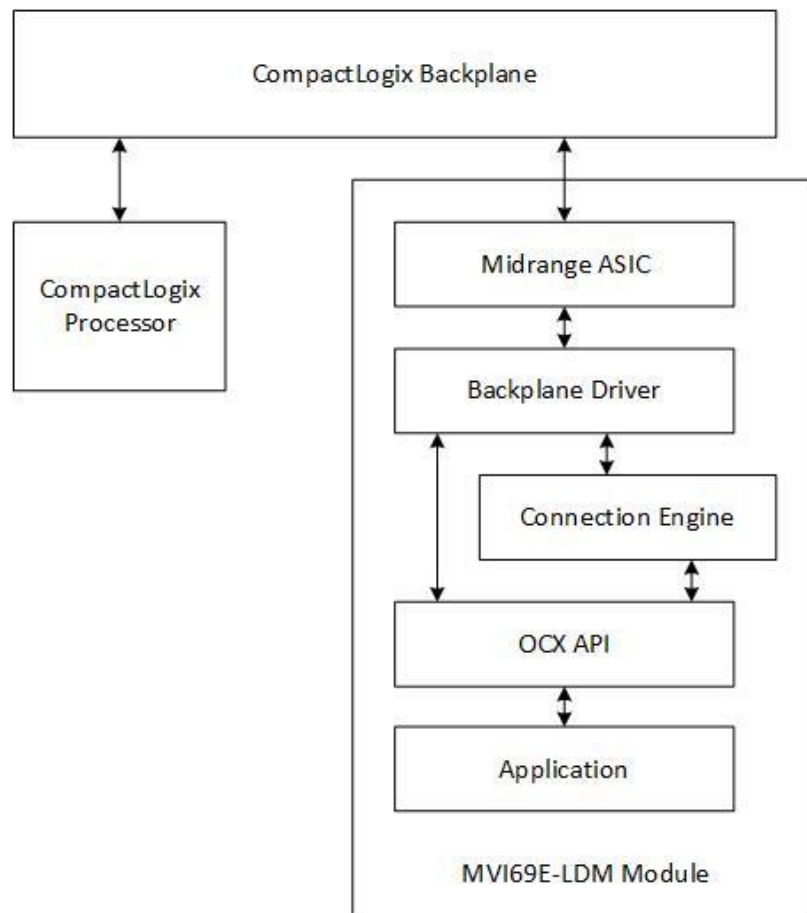

### 3.4 Backplane Device Driver

The backplane device driver performs CIP messaging over the CompactLogix backplane using the Midrange ASIC. The user application interfaces with the backplane device driver through the CIP API library. The backplane device driver for the MVI69E-LDM module is `libocxbpeng.so`. The driver implements the following components and objects:

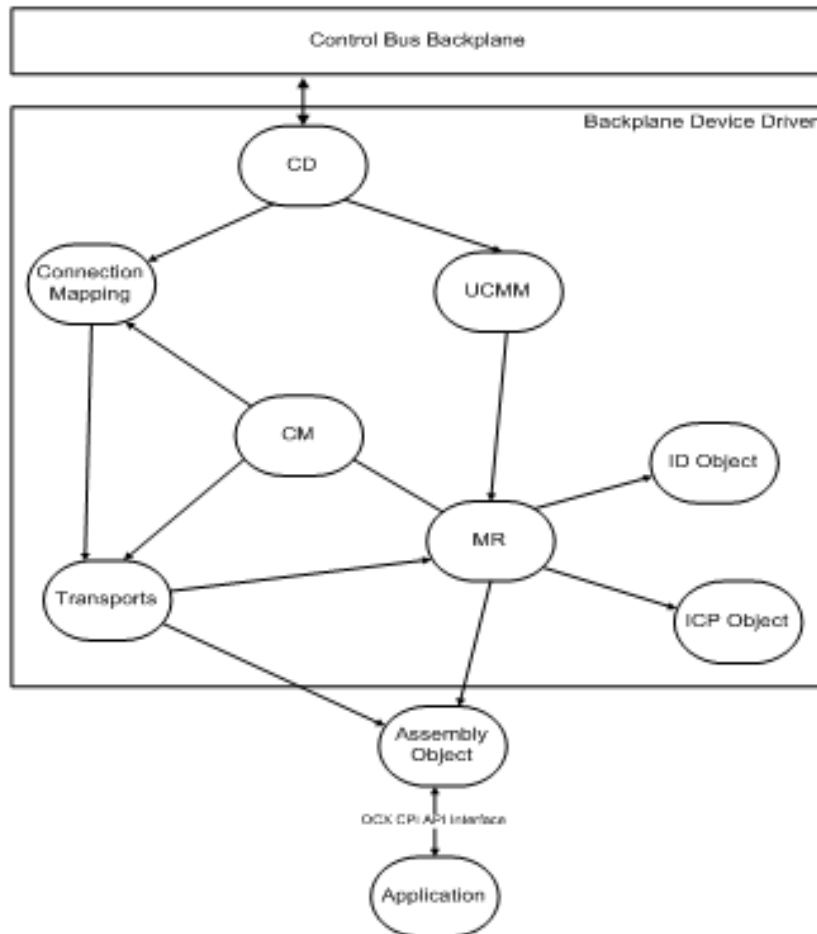

All data exchange between the application and the backplane occurs through the Assembly Object, using functions provided by the CIP API. The API includes functions to register or unregister the object, accept or deny Class 1 schedule connections requests, access scheduled connection data, and service unscheduled messages.

## 4 Sample Code

To help understand the use of the MVI69E-LDM, several example programs are provided with the module. These programs exist as source code in the development environment as well as executable programs in the MVI69E-LDM in the `/psft/sample` directory.

You can build and download the sample programs to the MVI69E-LDM module. The sample programs are designed to show one or more sets of functionality.

### LED Sample

- Opens the backplane
- Read and print module information
- Read and print version information
- Read and print module configuration jumpers
- Continuously change the state of the front panel LEDs

### Backplane Sample

- Opens the backplane
- Set up communications with the PLC
- Read and display module information
- Read and write connected data with the CompactLogix processor

### Server Ethernet Sample

- Opens the backplane
- Listens for a request on a well known port
- Responds with the date/time of the module

### Client Ethernet Sample

- Opens the backplane
- Sends a request to another module; to the server Ethernet Sample
- Prints the response to the terminal

### Serial Sample

- Opens the backplane
- Reads and modifies the serial configuration
- Transmits though the serial port

### Install LDM

- Sets the module identity to ProSoft LDM
- Opens the backplane
- Read and print module information

## 4.1 Establishing a Console Connection

In order to run the Ethernet and Serial samples and tutorials, you must set up a connection in order to communicate with the MVI69E-LDM.

### 4.1.1 Physically Connect to the Module

In order to establish a console session between a PC and the MVI69E-LDM, you must physically connect your PC to the console serial port on the module.

- 1 Plug in an RJ45 to DB9 cable on the module's Port 1.
- 2 Connect the null modem cable to the DB9 end of the RJ45 to DB9 cable.
- 3 Connect the other end of the null modem cable to the appropriate serial port (USB to Serial Converter) on the computer.

### 4.1.2 Configuring Serial Communication

- 1 Establish a connection to the module. The following example uses PUTTY. You can download PUTTY for free from:  
<http://www.chiark.greenend.org.uk/~sgtatham/PuTTY/download.html>  
<http://www.chiark.greenend.org.uk/~sgtatham/putty/download.html>
- 2 MVI69E login: `root`  
Password: `password`

**Note:** After the first successful login, you will be prompted to change the password. Be sure to record the new password in a safe place for future reference.

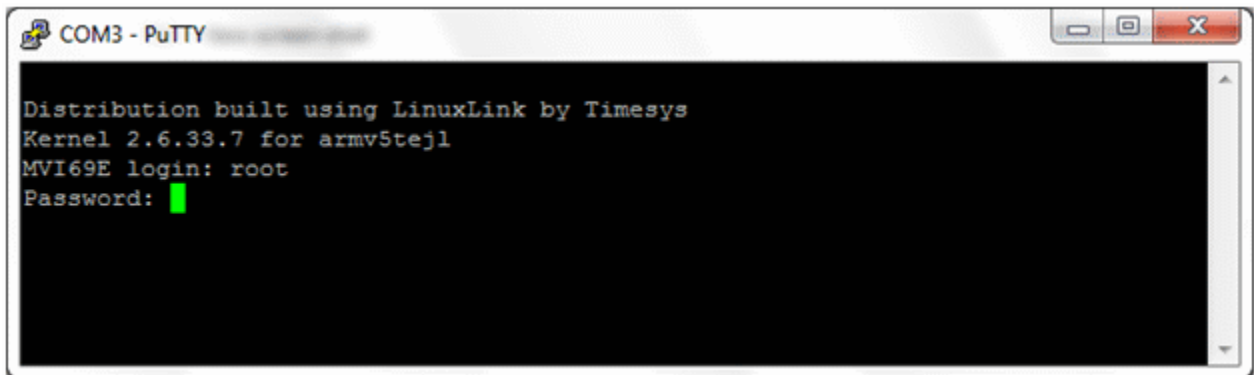

Keep PUTTY open while you set up CompactLogix as described in the next section.

### 4.1.3 Setting Up ControlLogix 5000

- 1 Open the MVI69E-LDM.ACD program and then click **CHANGE CONTROLLER** to change the appropriate chassis type to match your hardware and firmware.

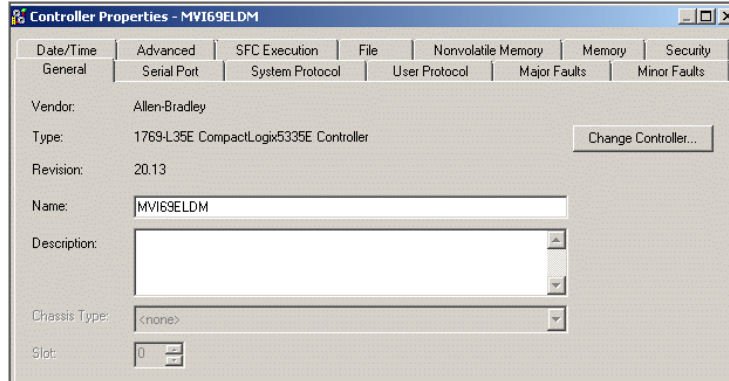

- 2 Select the **TYPE** and **REVISION** of your Controller and click **OK**.

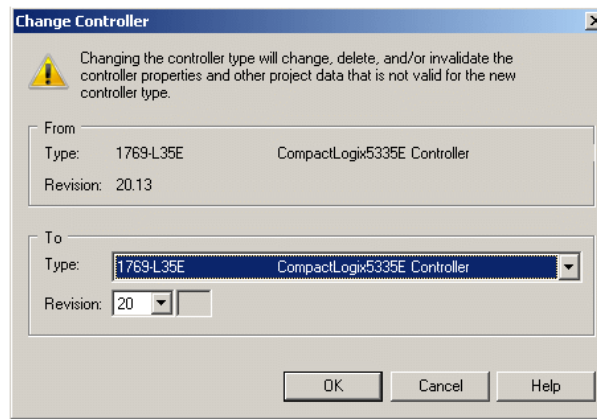

- 3 Download MVI69\_LDM.ACD file in the CompactLogix processor by choosing **COMMUNICATIONS > WHO ACTIVE > DOWNLOAD**.

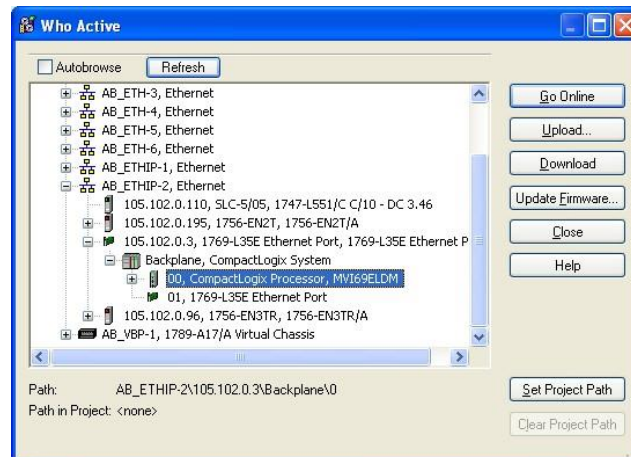

## 4.2 Sample Tutorials

The following sections describe how to run and understand the sample tutorials provided with the module. These samples handle the data exchange between the MVI69E-LDM and end device(s).

### 4.2.1 Ethernet Sample

The Ethernet sample comes as two programs; a client, and a server.

- The server waits for a client to request a connection, replies with the local time, and closes the connection.
- The client runs with the IP4 address of the server.
- The client opens a connection to the server, receives the response message, and prints the message (the time on the server) to the console.

It is recommended that you run the server on one MVI69E-LDM module and the client on another. Alternately, either of the programs could be ported to another Linux environment. Attempting to run both programs on the same MVI69E-LDM is not advised due to the complexity of IP routing.

#### Server ENet Sample

##### To run the Server ENet sample:

- 1 Establish a command window using Telnet or similar terminal software on the PC through the Serial P1 port.
- 2 Login as user: **root**, using password: **password**.

**Note:** After the first successful login, you will be prompted to change the password. Be sure to record the new password in a safe place for future reference.

- 3 The Ethernet Port E1 is used to communicate with the client device. The server and client devices must both be connected on the same IPv4 subnet.
- 4 Set the IPv4 address and mask of the Ethernet port using the `ifconfig` command.



**To execute the sample:**

- 1 Navigate to the default home directory `/psft/sample`.
- 2 Type the command `./Server_Sample&` to run the program as a background task. The server will wait forever processing requests from clients.

While reviewing the source code, you'll see that the program:

- registers `sigquit_handler` for four signals using the signal function.
- checks command line and prints usage message if needed.
- opens the backplane using `open_backplane()`. See the description in `Backplane_Sample`.
- initializes the LEDs on the front panel.
- Calls the function `socket()` to create an UN-named socket inside the kernel. `socket()` returns an integer known as a socket descriptor:
  - The function takes domain/family as its first argument. For Internet family of IPV4 addresses, use `AF_INET`.
  - The second argument `SOCK_STREAM` specifies that type of connection to use. In this case, a sequential, reliable, two way connection is desired.
  - The third argument select the protocol. Generally, this is zero as the system normally only has one protocol for each type of connection, although it is possible to have multiple protocols for a connection type. Zero tells the system to use the default protocol for the specified type of connection. In this case, the default is TCP.
- zeros out the `send_buff` and `serv_addr` variables.
- In preparation for the call to `bind()`, the `serv_addr` is then set to the well known port address `SERVER_PORT_NUMBER`, and any IP address. This allows a connection to be accepted from any IP address as long as the well known port address is specified.
- calls function `bind()` to assign the address specified in the structure `serv_addr` to the socket created by the call to `socket()`.
- calls function `listen()` with second argument as '10' to specify the maximum number of client connections that the server will queue for this listening socket.
- The call to `listen()` makes the socket a functional listening socket.
- Code enters an infinite while loop in which:
  - the call to `accept()` puts the server to sleep, waiting for an incoming client request. When a request is received and the three way TCP handshake is complete, `accept()` wakes up and returns the socket descriptor representing the client socket.
  - `time()` is called to read the current system time.
  - `snprintf()` is used to put the time into the send buffer in a human readable format.
  - `write()` is then called to send formatted time to the client.
  - `close()` is then used to close the connection to the client.
  - `sleep()` is invoked to yield the processor for one second.

## Client ENet Sample

### **To run the Client ENet Sample:**

- 1 Establish a command window using Telnet or similar terminal software on the PC through the Serial P1 port.
- 2 Login as user: `root`, using password: `password`.

**Note:** After the first successful login, you will be prompted to change the password. Be sure to record the new password in a safe place for future reference.

- 3 The Ethernet Port E1 will be used to communicate with the server. The server and client devices must both be connected on the same IPv4 subnet.
- 4 Set the IPv4 address and mask of the first Ethernet port using `ifconfig` command.

### **To execute the sample:**

- 1 Go to the default home directory `/psft/sample`.
- 2 Type the command `./Client_Sample ip.address.of.server` to run the program. The IP address of the server node must be provided in order for the server to know which node is executing the server program.
- 3 The client will send a connection request to the server, print the response from the server to the console, and then exit.

Reviewing the source code for `Client_Sample`, you will see that the main program:

- registers `sigquit_handler` for four signals.
- checks command line and print usage message if required.
- opens the backplane using `open_backplane()`. See the detailed description in `backplane_sample`.
- creates a socket with a call to `socket()`.
- initializes the server address (`serv_addr`) structure:
  - indicates that an IP4 address is going to be used with `AF_INET`.
  - sets the destination port is the well known port `SERVER_PORT_NUMBER`.
  - converts the string version of the server IP address to binary with `inet_pton()`.
- `connect()` is called to create the TCP connection to the server.
- When the sockets are connected, the server sends the date and time from the server as a message back to the clients. The client then uses the `read()` function to receive the buffer of data and prints the contents to the console.

## 4.2.2 Serial Sample

### **To run the Serial sample:**

- 1 Establish a command window using Telnet or similar terminal software on the PC through the Ethernet E1 port or Serial P1 port.
- 2 Login:  
user: root  
password: password

**Note:** After the first successful login, you will be prompted to change the password. Be sure to record the new password in a safe place for future reference.

### **To execute the sample:**

- 1 Navigate to the default home directory `/psft/sample`.
- 2 Type the command `./Serial_Sample ttyS1 test string` in order to run the program with `ttyS1` as the output, and "test string" sent to that port.

While reviewing the source code for `Serial_Sample`, you'll see that the main program:

- registers `sigquit_handler` for four signals.
- checks command line and print usage message if required.
- opens the backplane using `open_backplane()`. See the detailed description in `backplane_sample`.
- reads the serial configuration jumpers and ensures that both serial ports are configured as RS-232.
- opens the serial port using function `open_serial_port()`. Examine this function:
  - opens the serial device by calling `open()`.
  - reads current serial port attributes using `tcgetattr()`.
  - configures serial port attributes. The routine uses `cfsetispeed()` to set the baud rate. It then uses `tcsetattr()` to set the remaining attributes.
- initializes the LEDs on the front panel.
- enters a for loop which transmits a test string one character at a time by calling `write()` and sleeping for 500 msec using `usleep()`.
- closes the serial drive connection using `close()`.

### 4.2.3 LED Sample

This program shows how to interact with the MVI69E-LDM hardware at the most basic level.

#### **To run the LED sample:**

- 1 Establish a command window using Telnet or similar terminal software program on the PC, through either the Ethernet or Serial P1 port.
- 2 Login as user: **root**, using password: **password**.

**Note:** After the first successful login, you will be prompted to change the password. Be sure to record the new password in a safe place for future reference.

#### **To execute the sample:**

- 1 Navigate to the default home directory `/psft/sample` and type the command `./Led_Sample&`. This will run the `Led_Sample` program in the background.
- 2 Looking at the sample source, you'll see that the program:
  - o registers Linux event handlers using the `signal` function.
  - o opens a connection to the hardware via the MVI69 library API `MVI69_Open`. Although the `MVI69_OpenNB` routine could be used (since this sample does not communicate across the backplane).
  - o reads the module information using `MVI69_GetModuleInfo` and displays this information to the terminal.
  - o reads the version information of the MVI69 driver using `MVI69_GetVersionInfo` and displays this information to the terminal.
  - o reads the state of the serial configuration jumpers using `ShowSerialJumpers` and prints this information to the terminal.
  - o reads the state of the Setup Jumper using the function `MVI69_GetSetupJumper` and prints this information to the console.
  - o initializes all LEDs to OFF.
- 3 The program then uses two nested loops to cycle through the LEDs and changes the state of the LED to every possible display state. This uses the `MVI69_SetLED` function.
- 4 Exit the program by killing it (CTRL-C or `kill -9`).

#### 4.2.4 Backplane Sample

The Backplane Sample program shows block transfer communication with the CompactLogix controller in slot 0 of the CompactLogix rack. The CompactLogix controller must be loaded with the sample ladder logic and be configured to communicate with the MVI69E-LDM module. The ladder is `MVI69_LDMACD`.

##### To run the Backplane sample:

- 1 Establish a command window using Telnet or similar terminal software on the PC through either the Ethernet or Serial P1 port.
- 2 Login  
user: root  
password: password

**Note:** After the first successful login, you will be prompted to change the password. Be sure to record the new password in a safe place for future reference.

##### To execute the sample:

- 1 Navigate to the default home directory `/psft/sample` and type the command `./Backplane_Sample&` to run this program as a background task.
- 2 Reviewing the source code for the Backplane Sample, the program:
  - registers Linux event handlers using the `signal` function.
  - opens a connection to the hardware via the backplane library API using the `open_backplane` routine. The `open_backplane` will:
    - change the module information with the `MVI69_SetModuleInfo` routine.
    - call `MVI69_Open` to get access to the LDM hardware and backplane. (This call will wait in a loop until backplane access is obtained)
    - read the size of the configured IO using `MVI69_GetIOConfig`.
    - read and display the module identity using `MVI69_GetModuleInfo`.
  - sets each of the front panel LEDs to a default using the `MVI69_SetLED` function.
  - enters a main (infinite loop) within this loop. The program will:
    - first read the current run/program mode of the processor using `MVI69_GetScanMode`, and prints the state if it has changed since the last time it was read.
    - wait for an Input Scan from the CompactLogix processor using the `MVI69_WaitForInputScan` function.  
**Note:** `MVI69_WaitForOutputScan` could also be used.
    - `MVI69_GetScanCounter` function is used to read the number of the scan. The scan count modulo 5000 is used in data write (i.e., controller input data) a few lines below.
    - read output data (read data for the module) from the controller using the function `MVI69_ReadOutputImage`.
    - If the second element has changed since the last read, the new data is copied from the read (controller output) data to the write (controller input) data. If the data has not changed, the data in the writer buffer is decremented. The scan count (read above) is written to the 0th element.
    - write the data back for the controller to read using the `MVI69_WriteInputImage` function.

### 4.3 Application Tutorials

The following sections describe how to run and understand the sample applications provided with the module. These applications handle the data exchange between the backplane, MVI69E-LDM, and end device(s).

#### 4.3.1 Ethernet Application

You cannot run this sample if Backplane\_Sample is running. Backplane\_Sample runs by default during startup. To run the enet\_application sample, you must kill the Backplane\_Sample script. See the section entitled "*Important Module Startup Information - Please Read*" for information on how to kill or change the Backplane\_Sample script.

The Ethernet Communications program illustrates how to interact with the MVI69E-LDM using its Ethernet port as both a server and a client communicating through the backplane to send and receive data. The sample also uses multi-threading in order to run as both a server and client asynchronously.

#### To test the MVI69E-LDM as a client:

- 1 Set up TCP Stress Tester as a server with the following parameters:
  - **PORT:** 5000
  - **CONNECTION:** TCP
  - **SEND SPEED:** Single
  - **TYPE:** Server
- 2 Subnet Example: 10.1.3.x (or default 192.168.0.250)
- 3 Click **OPEN** and allow the TCP Stress Tester to listen once the sample program launches (steps to launch the sample program below)..

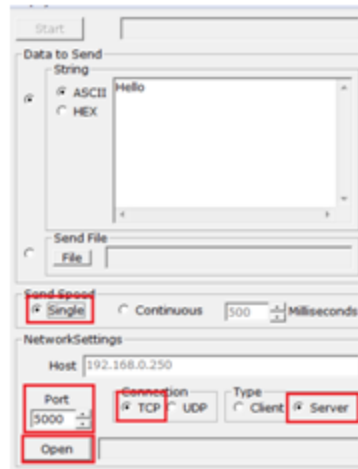

**To test the MVI69E-LDM as a server:**

**1** Set up TCP Stress Tester as a client:

- **PORT:** 6000
- **CONNECTION:** TCP
- **SEND SPEED:** Single
- **TYPE:** Client

Subnet Example: 10.1.2.x (or default 192.168.1.250).

**2** Ensure that you use the IP address of one of the two Ethernet ports available on the MVI69E-LDM as the HOST address (information to access / set IP addresses in the module is discussed later).

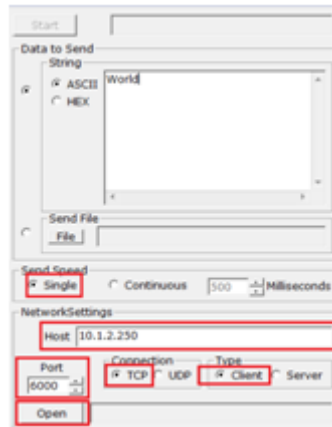

**3** Launch the sample ladder for the MVI69E-LDM in RSLogix 5000. Please observe that the module is not proceeding with I/O communications. This is normal. The sample program initiates backplane communication.

**4** To communicate on the MVI69E-LDM, use Telnet or other terminal connection program to open a serial connection (baud 115200) to the COM port of choice on either of the two computers.

**To change Ethernet port IP addresses to use the subnets chosen temporarily:**

**1** Type in the terminal console:

`ifconfig eth0 x.x.x.x` where 'x' is your IP address of choice for Ethernet Port 0.

**2** Navigate to the sample directory

`cd /psft/sample.`

**3** Type command `./enet_application` without the destination IP address when testing the MVI69E-LDM as a server. Type command `./enet_application x.x.x.x` where 'x' is the destination IP address of the server running TCP Stress Tester when testing the MVI69E-LDM as a client.

**To initiate external client communication:**

Click **OPEN** once the Ethernet Communications sample is running in RSLogix 5000 (you may have to click twice depending on your computer).

Once the program is running and a TCP Tester server and client information is established, data is received through the backplane and to/from the TCP Stress Testing applications and RSLogix 5000. The program modifies the tags within RSLogix 5000 using the sample ladder provided with any string input:

- Input Tags: 0-9 can be modified by the MVI69E-LDM client for the MVI69E-LDM.
- Output Tags: 0-9 can be modified by the TCP Tester server for the MVI69E-LDM.
- Input Tags: 11-20 can be modified by the MVI69E-LDM server of the MVI69E-LDM.
- Output Tags: 10-19 can be modified by the TCP Tester client of the MVI69E-LDM

Please note that it is recommended to set the 'Style' in RSLogix 5000 to 'ASCII' instead of INT or Hex due to the way that RSLogix 5000 interprets bytes and byte order.

RSLogix 5000 creates a high byte and low byte for each tag in its database. For example, if the word 'Hello!' was typed from the TCP Stress Tester, RSLogix5000 separates the values to:

- 'eH'
- 'll'
- 'lo'

Since the values are read in byte order (from right most to left most), there is a high byte and low byte used and RSLogix 5000 combines those byte values in you choose to view it as in INT or Hex value.

For example, the letters 'te' in a single tag are separated and combined as follows:

**Binary Value: 01110100      0110010**

Local:5:0	{...}	{...}	AB:1756_MODULE_IN...
Local:5:0.Data	{...}	{...}	INT[248]
Local:5:0.Data[0]	2#0111_0100_0110_0101	Binary	INT

**ASCII:            t            e**

Local:5:0	{...}	{...}	AB:1756_MODULE_IN...
Local:5:0.Data	{...}	{...}	INT[248]
Local:5:0.Data[0]	'te'	ASCII	INT

**Combined Binary Value: 0111010001100101 = 29797 int**

Local:5:0	{...}	{...}	AB:1756_MODULE_IN...
Local:5:0.Data	{...}	{...}	INT[248]
Local:5:0.Data[0]	29797	Decimal	INT

**ASCII (INT Value): 101   116**

```
CLIENT: Broadcasting Message to External Server: 101, 116, 116, 115, 109, 32, 15, 101, 97, 115, 101
```



The sample application can have its sample ladder input tags modified via TCP Stress Tester either through the external server or the client by creating any string value up to 10 tag entries long (20 characters total, including spaces):

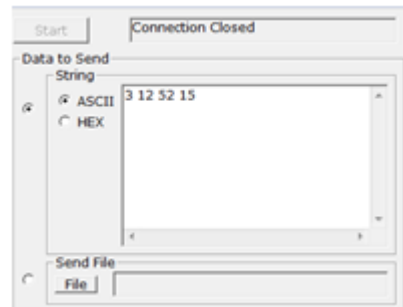

Click **START** to transmit the data from the computer into the module and backplane. It is then updated in RSLogix 5000 with the appropriate number associations.

As mentioned earlier, all character data is sent to RSLogix 5000 in sets of two per tag since each tag is 16 bits in length and each ASCII character resides in 8 bits (one byte). All ASCII information for each tag reads from right to left (low byte to high byte) as shown in the following example:

### MVI69E-LDM Running as a Server

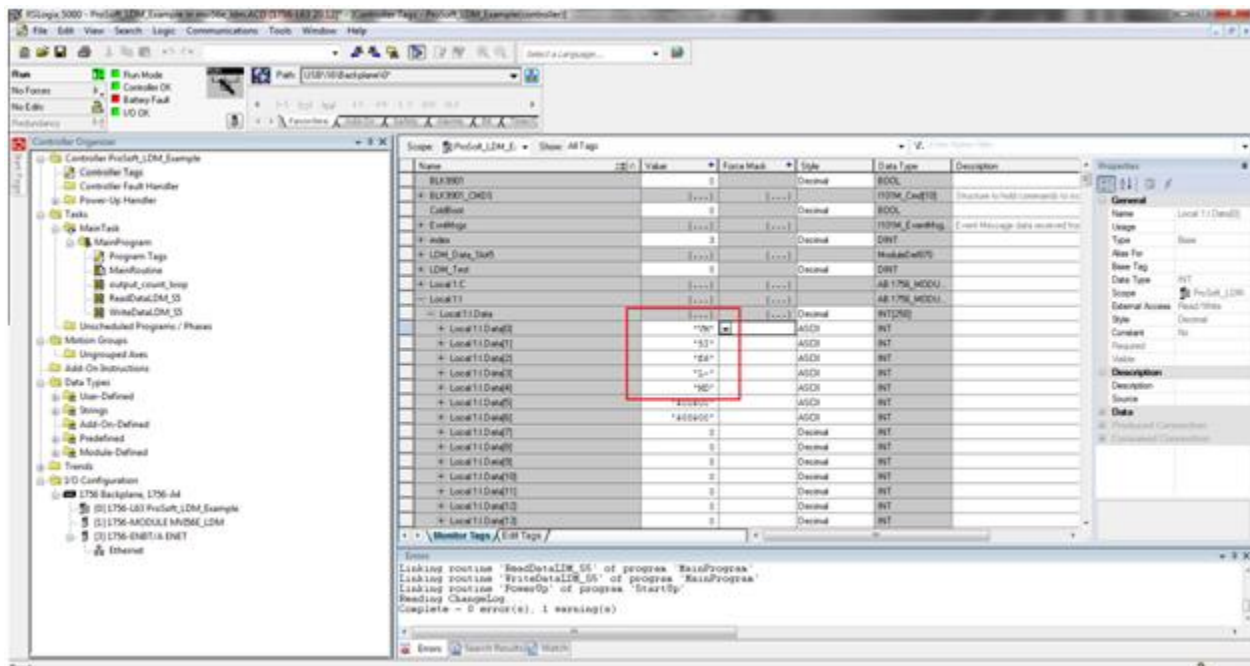

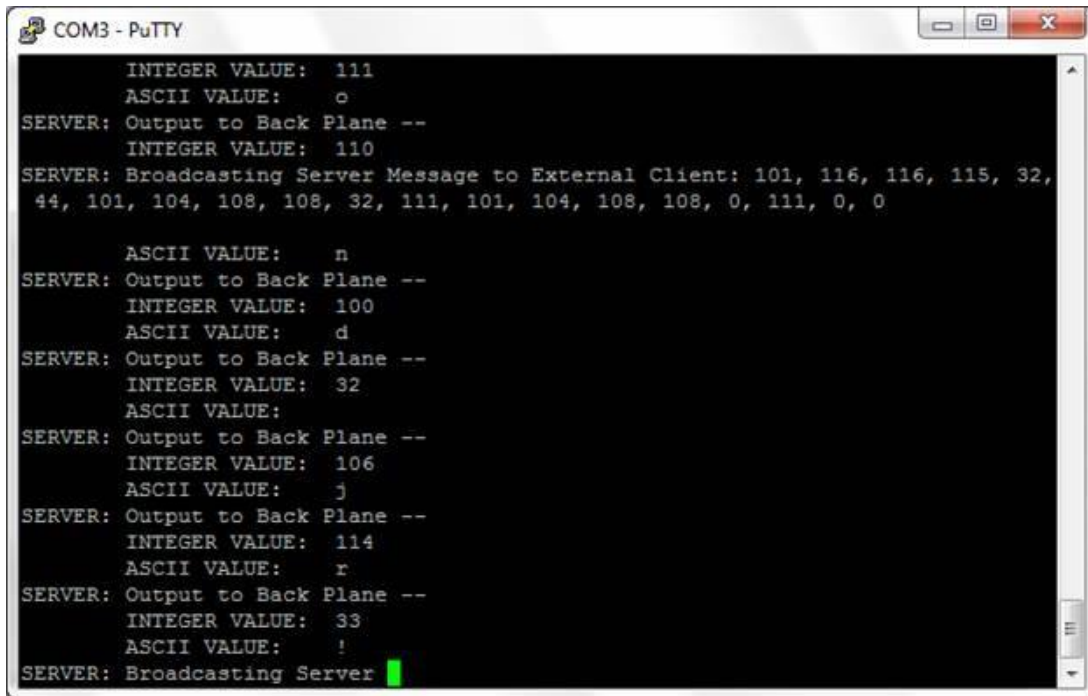
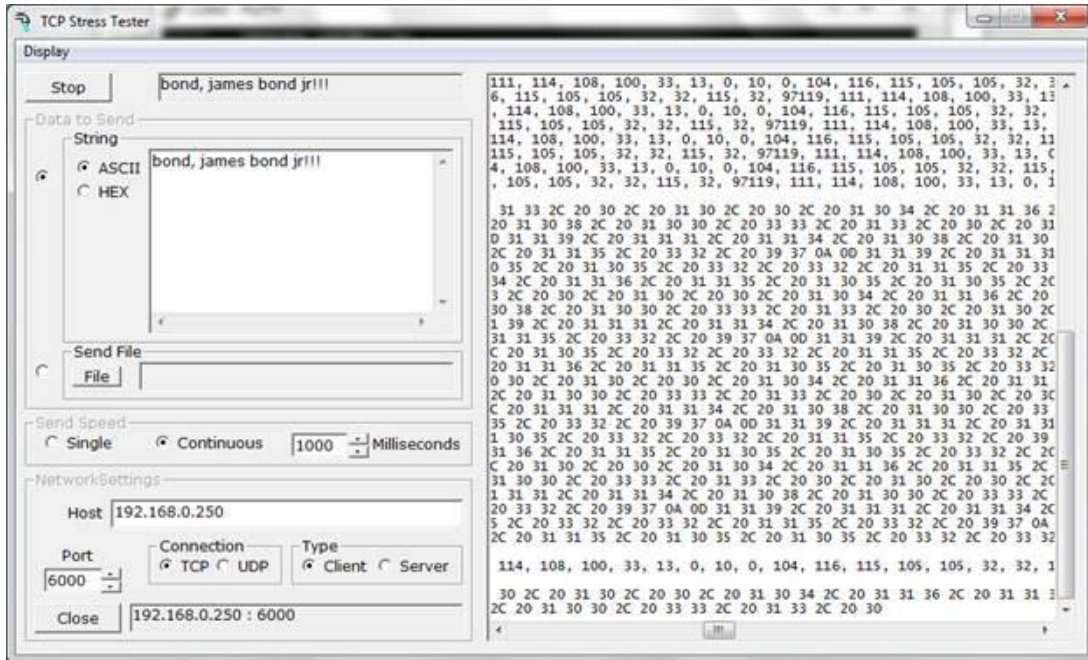

### MVI69E-LDM Running as a Client

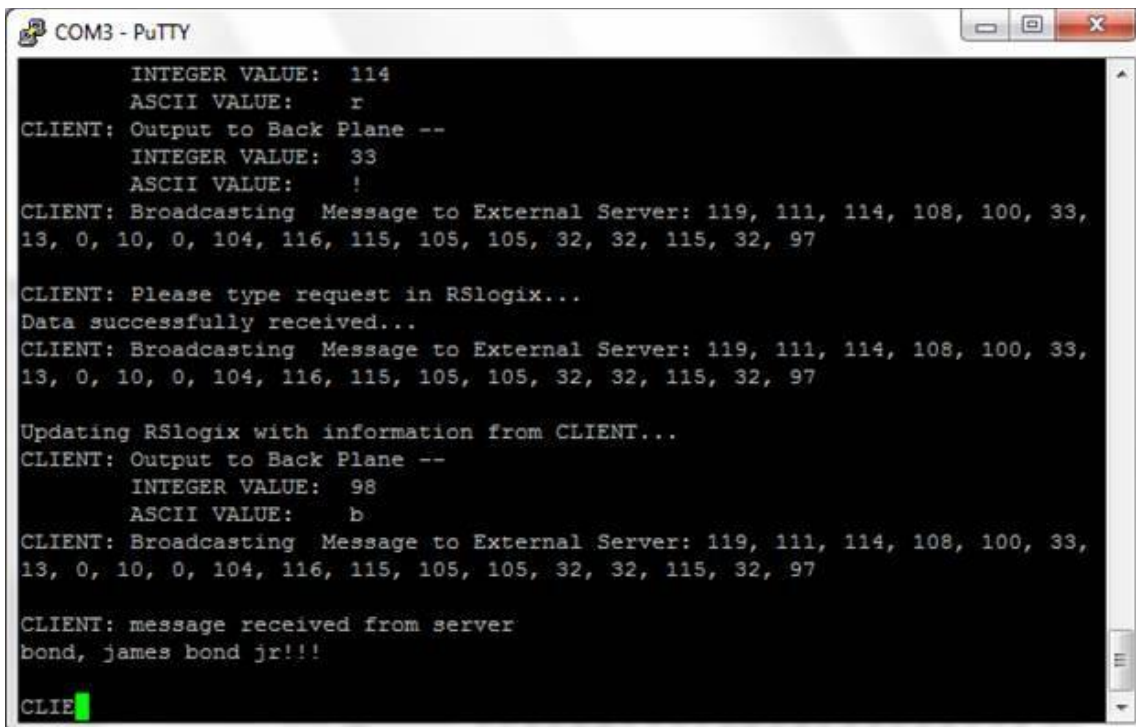
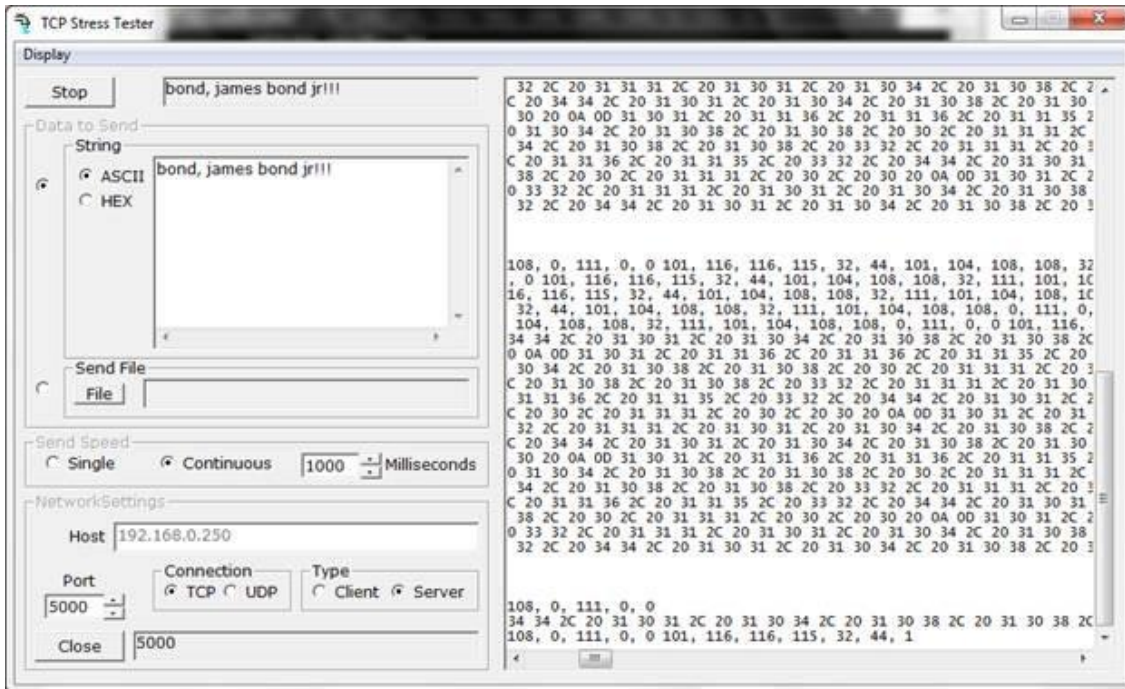

The following diagram shows the multi-threading hierarchy. All threads (excluding the main thread) can be removed/disabled and the sample will continue to function as directed, excluding the functionality of the removed thread and any child threads associated with it.

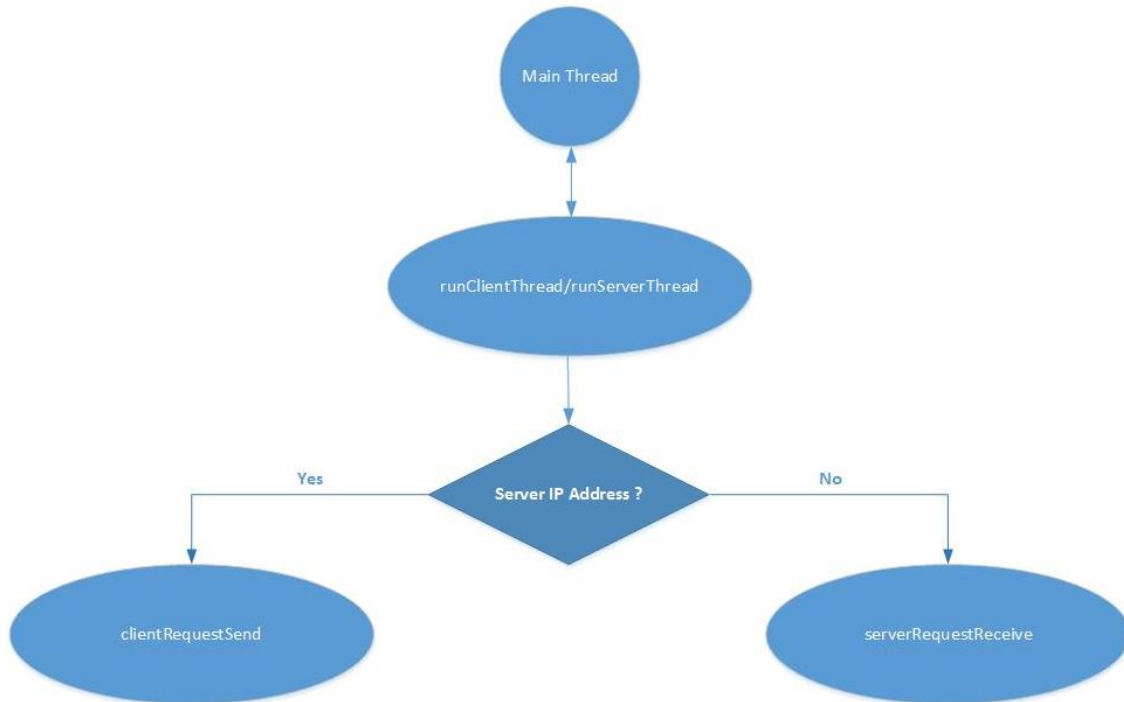

### 4.3.2 Serial Application

You cannot run this sample if Backplane\_Sample is running. Backplane\_Sample runs by default during startup. To run the serial\_application sample, you must kill the Backplane\_Sample script. See the section entitled "*Important Module Startup Information - Please Read*" for information on how to kill or change the Backplane\_Sample script.

The Serial\_Application shows an example of how you can use the LDM module to communicate to an end device to transmit/receive ASCII strings from the CompactLogix processor through the backplane to the LDM module on the bottom serial port (default application port). This same sample program:

- Streams ASCII data into the module from the end device on the same serial port.
- Sends the data to the backplane to the controller tags of the CompactLogix.
- Sends out the number of bytes entered in Write\_Byte\_Cnt Controller tag continuously after the Serial\_App\_Sample\_WriteTrigger tag has been triggered from the default application port.
- Streams in ASCII data from the end device into the Controller tag Local:1:I.Data.

***To run the Serial Application sample:***

Use HyperTerminal or a similar program to perform the following steps.

- 1 Open HyperTerminal.
- 2 Enter a name and choose an icon for the connection.



- 3 Choose the appropriate COM port.



- 4 Use the following settings for the Serial\_Application program.
- **BITS PER SECOND:** 115200
  - **DATA BITS:** 8
  - **PARITY:** None
  - **STOP BITS:** 1
  - **FLOW CONTROL:** None

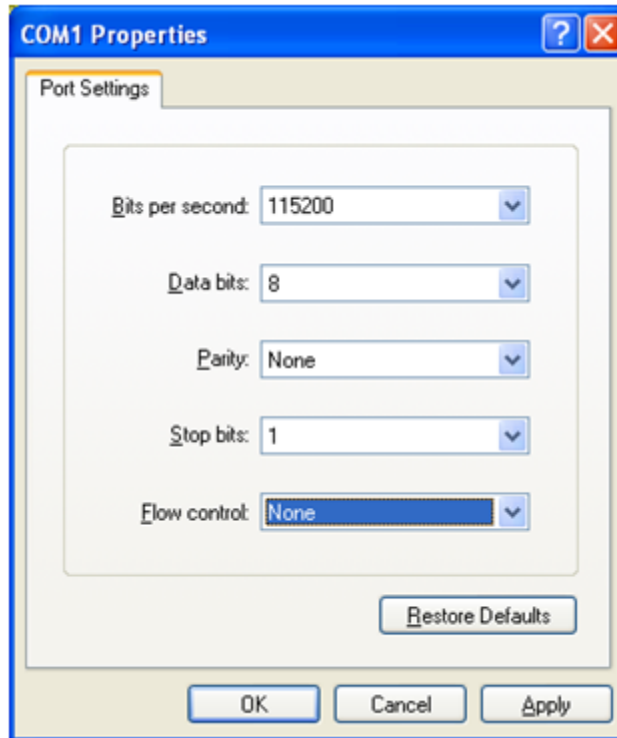

- 5 Under the **ASCII SETUP**, select **ECHO TYPED CHARACTER LOCALLY**. This allows you to see the stream data being sent to the LDM module on the HyperTerminal screen.

- Click **OK**, but keep HyperTerminal open since you will use it again after you complete the following sections.

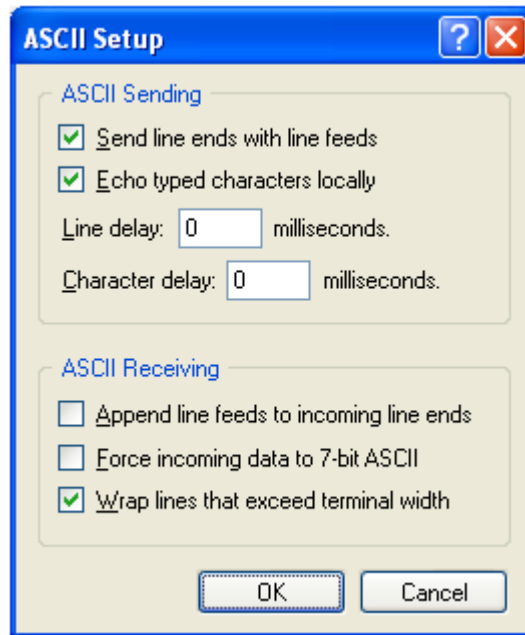

- Use PuTTY or Telnet to log into the module.

MVI69E login: `root`

Password: `password`

**Note:** After the first successful login, you will be prompted to change the password. Be sure to record the new password in a safe place for future reference.

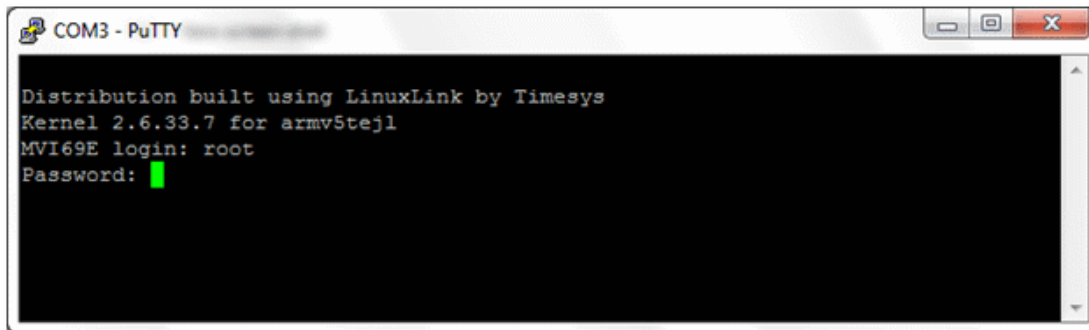

- 8 Change to the Sample directory:  
`cd /psft/sample`

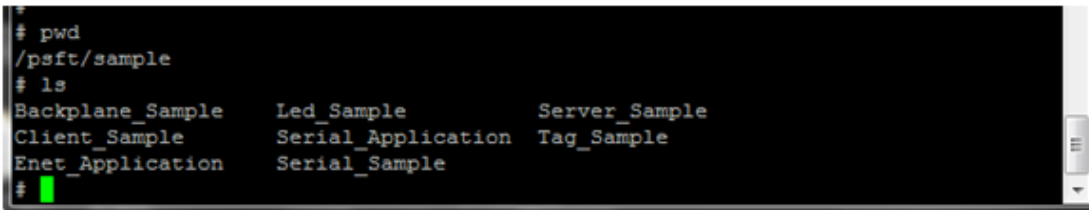

```
# pwd
/psft/sample
# ls
Backplane_Sample  Led_Sample      Server_Sample
Client_Sample     Serial_Application  Tag_Sample
Enet_Application  Serial_Sample
```

- 9 Type `./` and the name of the sample program that you want to run. In this example, type:  
`./Serial_Application&`

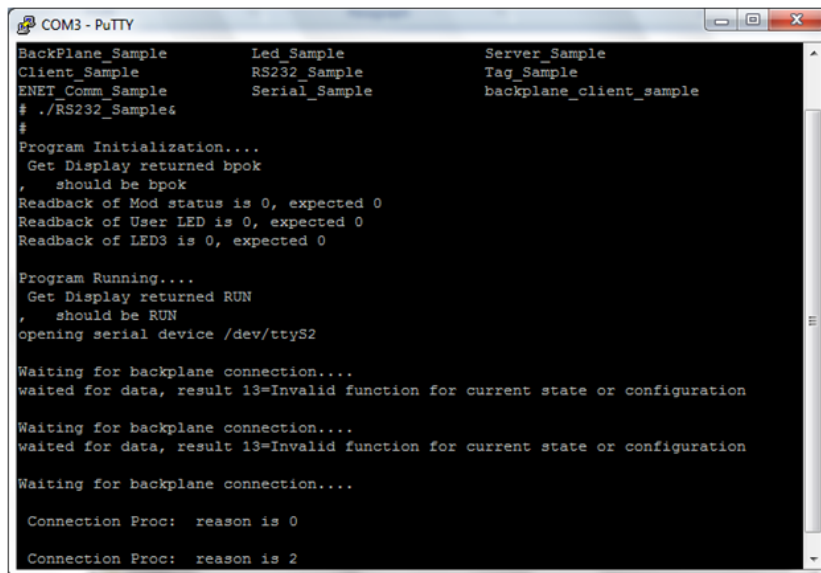

```
COM3 - PuTTY
BackPlane_Sample  Led_Sample      Server_Sample
Client_Sample     RS232_Sample   Tag_Sample
ENET_Comm_Sample  Serial_Sample   backplane_client_sample
# ./RS232_Sample&
#
Program Initialization...
Get Display returned bpok
, should be bpok
Readback of Mod status is 0, expected 0
Readback of User LED is 0, expected 0
Readback of LED3 is 0, expected 0

Program Running...
Get Display returned RUN
, should be RUN
opening serial device /dev/ttyS2

Waiting for backplane connection...
waited for data, result 13=Invalid function for current state or configuration

Waiting for backplane connection...
waited for data, result 13=Invalid function for current state or configuration

Waiting for backplane connection...

Connection Proc: reason is 0

Connection Proc: reason is 2
```

- 10 Keep PuTTY or Telnet open and set up the CompactLogix 5000 program as described in Setting Up the ControlLogix 5000.



- 11 Open the MVI69E-LDM.ACD program and change the appropriate chassis type to match your hardware and firmware.

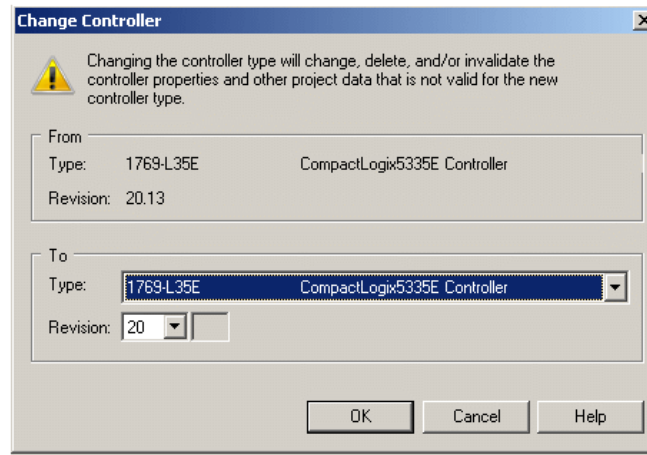
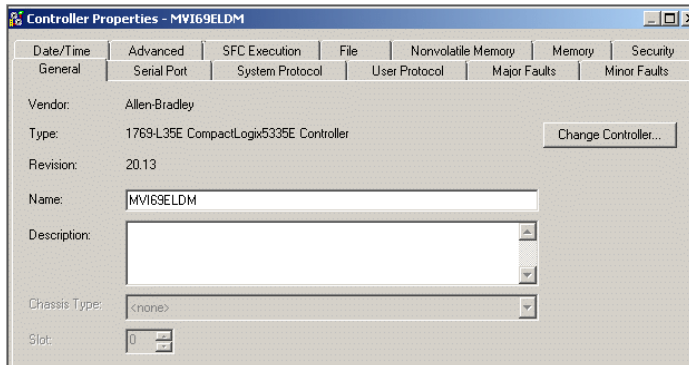

- 12 Download the MVI69E-LDM.ACD file in the CompactLogix processor by choosing **COMMUNICATIONS > WHO ACTIVE > DOWNLOAD**.

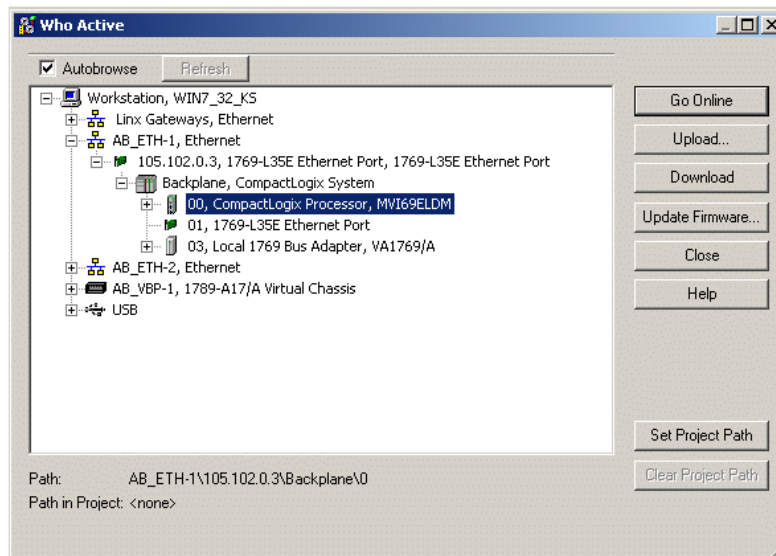

### 13 Trigger 'Serial\_ENET\_App\_Sample\_On\_Trigger' by right-clicking the Controller tag and choosing **TOGGLE BIT**.

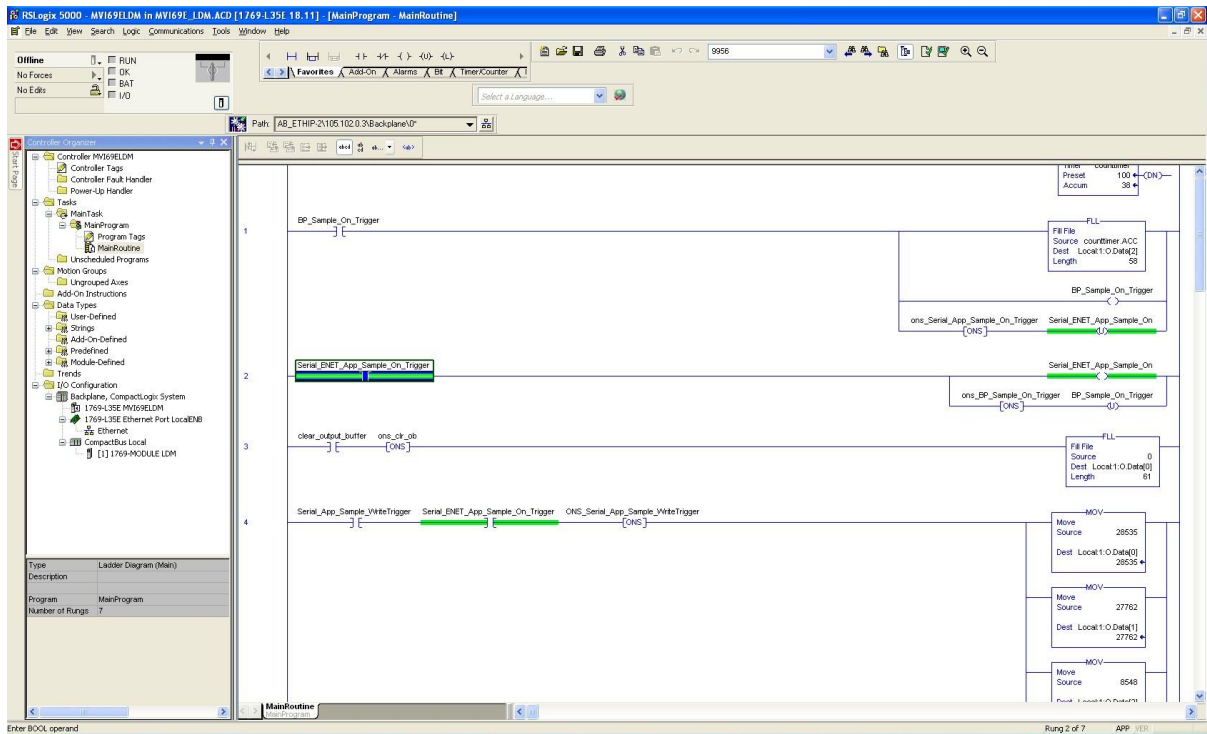

This causes the MVI69E-LDM module to send out the text `world!` to the console.

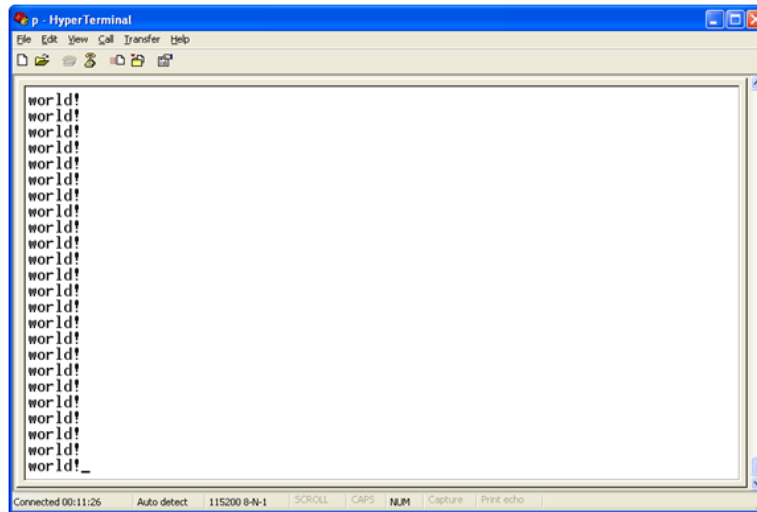

**14** You can view how the stream of data is accepted by the LDM module by untoggling the Serial\_App\_Sample\_WriteTrigger and typing a string of characters on the console.

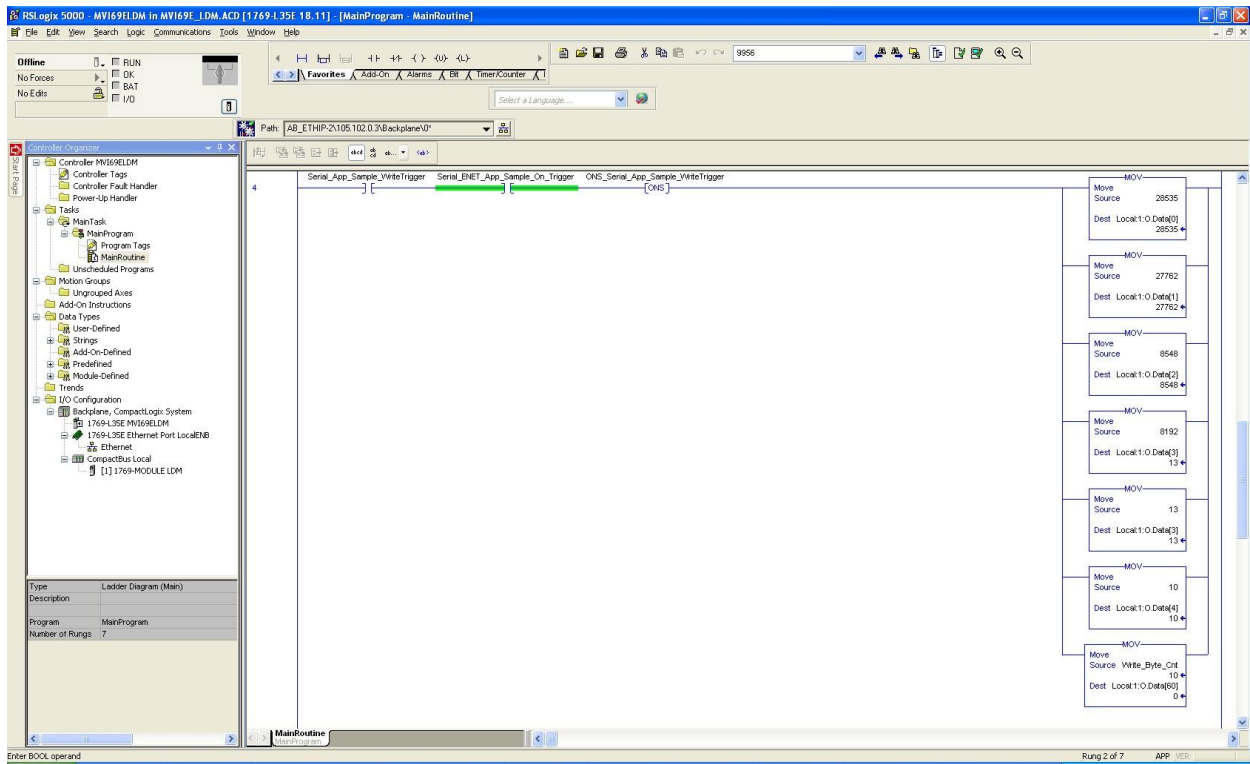

15 You can see the letter 'h' in the location 'Local:1:1.Data'. Make sure that the **STYLE** column in the CompactLogix is set to ASCII.

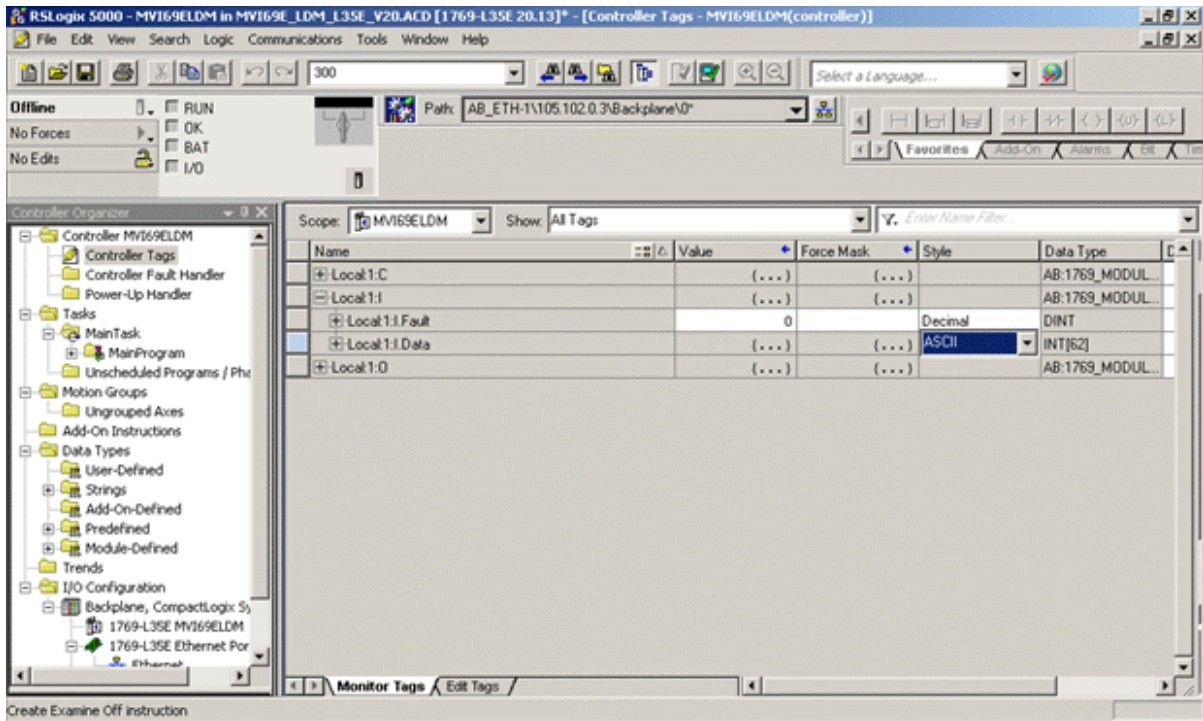

16 You can also observe this on the console port as well.

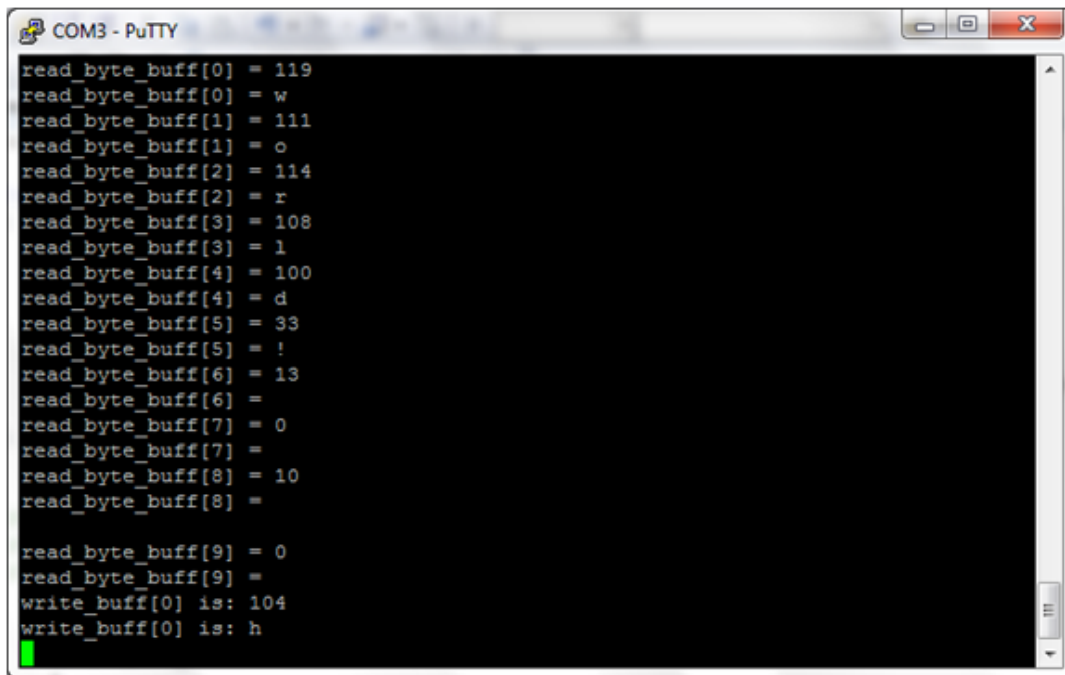

## 5 API Functions

### 5.1 CIP API Initialization Functions

#### MVI69\_Open

---

##### Syntax

```
int MVI69_Open(MVI69HANDLE *handle);
```

##### Parameters

handle	Pointer to variable of type MVI69HANDLE
--------	---

##### Description

`MVI69_Open` acquires access to the API and sets `handle` to a unique ID that the application uses in subsequent functions. This function must be called before any of the other API functions can be used (with the exception of `MVI69_SetModuleInfo`).

The function provides full access to the backplane and all of the API functions. Only one program is allowed to call this function.

**IMPORTANT:** Once the API is opened, `MVI69_Close` should always be called before exiting the application.

##### Return Value

<code>MVI69_SUCCESS</code>	API was opened successfully
<code>MVI69_ERR_REOPEN</code>	API is already open
<code>MVI69_ERR_NODEVICE</code>	Backplane driver could not be accessed

**Note:** `MVI69_ERR_NODEVICE` will be returned if the backplane device driver is not loaded.

##### Example

```
MVI69HANDLE Handle;  
    if (MVI69_Open(&Handle) != MVI69_SUCCESS)  
{  
    printf ("Open failed!\n");  
}  
else  
{  
    printf ("Open succeeded\n");  
}
```

##### See Also

`MVI69_Close`  
`MVI69_OpenNB`

---

## MVI69\_OpenNB

---

### Syntax

```
int MVI69_OpenNB(MVI69HANDLE *handle);
```

### Parameters

---

Handle	pointer to variable of type MVI69HANDLE
--------	---

---

### Description

MVI69\_OpenNB acquires access to the API and sets `Handle` to a unique ID that the application uses in subsequent functions. This function must be called before any of the other API functions can be used.

The purpose of this function is to provide access to certain API functions even if the API is already in use by another program. This function does not provide access to the backplane; however, it does provide access to the following functions.

```
MVI69_GetModuleInfo  
MVI69_GetSerialConfig  
MVI69_SetSerialConfig  
MVI69_GetSetupJumper  
MVI69_SetLED  
MVI69_GetVersionInfo
```

**IMPORTANT:** Once the API has been opened, `MVI69_Close` should always be called before exiting the application.

### Return Value

---

MVI69_SUCCESS	API was opened successfully
MVI69_ERR_REOPEN	API is already open
MVI69_ERR_NODEVICE	Backplane driver could not be accessed.

---

**Note:** `MVI69_ERR_NODEVICE` is returned if the backplane device driver is not loaded.

### Example:

```
MVI69Handle Handle;  
if ( MVI69_OpenNB(&handle) != MVI69_SUCCESS) {  
    printf ("Open failed!\n");  
} else {  
    printf ("Open succeeded!\n");  
}
```

### See Also

MVI69\_Open  
MVI69\_Close

---

## MVI69\_Close

---

### Syntax

```
int MVI69_Close(MVI69HANDLE handle);
```

### Parameters

---

handle	handle returned by previous call to MVI69_Open or MVI69_OpenNB
--------	--

---

### Description

This function is used by an application to release control of the API.

*handle* must be a valid handle returned from MVI69\_Open or MVI69\_OpenNB.

**IMPORTANT:** Once the API has been opened, this function should always be called before exiting the application.

### Return Value

---

MVI69_SUCCESS	API was closed successfully
MVI69_ERR_NOACCESS	<i>handle</i> does not have access

---

### Example

```
MVI69HANDLE handle;  
MVI69_Close (handle);
```

### See Also

MVI69\_OpenNB

MVI69\_Open

After the CIP API has been opened, this function should always be called before exiting the application.

---

## MVI69\_GetIOConfig

---

### Syntax

```
int MVI69_GetIOConfig(MVI69HANDLE    apihandle,  
                    MVI69_IOCONFIG *ioconfig);
```

### Parameters

handle	handle returned by previous call to MVI69_Open
ioconfig	Pointer to MVI69IOCONFIG structure to receive configuration information.

### Description

This function is used to obtain the IO configuration of the MVI69E module. *handle* must be a valid handle returned from MVI69\_Open.

The MVI69IOCONFIG structure is defined as shown:

```
typedef struct tagMVI69IOCONFIG  
{  
    WORD MappedInputWords; //Input words available for direct access  
    WORD MappedOutputWords; //Output words available for direct access.  
    WORD MsgRcvBufSize; //Max size in words for received messages.  
    WORD MsgSndBufSize; //Max size in words for sent messages.  
} MVI69IOCONFIG;
```

The maximum sizes in words of the module's input images are returned in the MVI69IOCONFIG structure pointed to by *ioconfig*. The *MappedInputWords* and *MappedOutputWords* members are set equal to the number of words of the respective image that is available for direct access via the *MVI69\_WriteInputImage* or *MVI69\_ReadOutputImage* functions. The *MsgRcvBufSize* and *MsgSndBufSize* members indicate the maximum size in words for received or sent messages respectively..

### Return Value

MVI69_SUCCESS	no errors were encountered
MVI69_ERR_NOACCESS	handle does not have access

### Example

```
MVI69HANDLE handle;  
MVI69IOCONFIG ioconfig;  
  
MVI69_GetIOConfig (handle, &ioconfig);  
printf ("%d words of input image available\n", ioconfig.DirectInputSize);  
printf ("%d words of output image available\n", ioconfig.DirectOutputSize);
```

### See Also

MVI69\_SetIOConfig



---

## MVI69\_SetIOConfig

---

### Syntax

```
int MVI69_SetIOConfig(MVI69HANDLE    ahandle,  
                    MVI69_IOCONFIG *ioconfig);
```

### Parameters

handle	handle returned by previous call to MVI69_Open
ioconfig	Pointer to MVI69IOCONFIG structure to receive configuration information.

### Description

This function may be used to set the size of the module's IO images available for direct IO access. *handle* must be a valid handle returned from MVI69\_Open.

The actual number of input and output words that are transferred between the controller and the MVI69E module is determined by the configuration of the generic profile. The only purpose of this routine is to set maximum sizes allowed by the MVI69\_ReadOutputImage and MVI69\_WriteInputImage functions.

The message buffer sizes are fixed. Therefore, the `MsgRcvBufSize` and `MsgSndBufSize` members are ignored by this function.

### Return Value

MVI69_SUCCESS	no errors were encountered
MVI69_ERR_NOACCESS	handle does not have access
MVI69_ERR_BADCONFIG	Configuration is not valid

### Example

```
MVI69HANDLE handle;  
MVI69IOCONFIG ioconfig;  
  
ioconfig.DirectInputSize = 20; //20words used for input  
ioconfig.DirectOutputSize = 10; //10 words used for output  
if (MVI69_SUCCESS !=MVI69_SetIOConfig (handle, &ioconfig))  
    printf ("Error: IO COnfiguration failed\n");
```

### See Also

MVI69\_GetIOConfig

## 5.2 Direct I/O Access

### MVI69\_ReadOutputImage

---

#### Syntax

```
int MVI69_ReadOutputImage (MVI69HANDLE handle,  
                           WORD offset,  
                           WORD length,  
                           WORD *buffer);
```

#### Parameters

handle	handle returned by previous call to MVI69_Open
offset	word offset into output image at which to begin reading
length	number of words to read
buffer	pointer to buffer to receive data from output image

#### Description

MVI69\_ReadOutputImage reads from the module's output image.

handle must be a valid handle returned from MVI69\_Open.

buffer must point to a buffer of at least length words in size.

offset specifies the word in the output image to begin reading, and length specifies the number of words to read. The error MVI69\_ERR\_BADPARAM will be returned if an attempt is made to access the output image beyond the range configured for direct IO. See the MVI69\_GetIOConfig and MVI69\_SetIOConfig functions for more information.

The output image is written by the control processor and read by the module.

#### Return Value

MVI69_SUCCESS	data was read from the output image successfully
MVI69_ERR_NOACCESS	handle does not have access
MVI69_ERR_BADPARAM	Parameter contains invalid value

#### Example

```
MVI69HANDLE handle;  
WORD        buffer[8];  
int         rc;  
  
/* Read 8 words of data from the output image, starting with word 2*/  
rc = MVI69_ReadOutputImage (Handle, 2, 8, buffer);  
if (rc != MVI69_SUCCESS)  
    printf("ERROR: MVI69_ReadOutputImage failed");
```

#### See Also

MVI69\_GetIOConfig  
MVI69\_SetIOConfig  
MVI69\_WriteInputImage

## MVI69\_WriteInputImage

---

### Syntax

```
int MVI69_WriteInputImage (MVI69HANDLE handle,
                           WORD  offset,
                           WORD  length,
                           WORD  *buffer);
```

### Parameters

handle	handle returned by previous call to MVI69_Open
offset	word offset into output image at which to begin writing
length	number of words to write
buffer	pointer to buffer of data to be written to input image

### Description

MVI69\_WriteInputImage writes to the module's input image.

handle must be a valid handle returned from MVI69\_Open.

buffer must point to a buffer of at least length words in size.

offset specifies the word in the output image to begin reading, and length specifies the number of words to write. The error MVI69\_ERR\_BADPARAM will be returned if an attempt is made to access the input image beyond the range configured for direct IO. If this error is returned, no data will be written to the input image. See the MVI69\_GetIOConfig and MVI69\_SetIOConfig functions for more information.

The input image is written by the module and read by the control processor.

### Return Value

MVI69_SUCCESS	data was written to the input image successfully
MVI69_ERR_NOACCESS	handle does not have access
MVI69_ERR_BADPARAM	Parameter contains invalid value

### Example

```
MVI69HANDLE handle;
WORD        buffer[2];
int         rc;

/* Write 2 words of data to the input image, starting with word 0*/
rc = MVI69_WriteInputImage (Handle, buffer, 0, 2);
if (rc != MVI69_SUCCESS)
    printf("ERROR: MVI69_WriteInputImage failed");
```

### See Also

MVI69\_GetIOConfig

MVI69\_SetIOConfig

MVI69\_ReadOutputImage

### 5.3 Messaging

#### MVI69\_GetMsgRequestFromBp

##### Syntax

```
int MVI69_GetMsgRequestFromBp(MVI69HANDLE handle,
                              WORD *buffer,
                              WORD *length,
                              WORD reserved,
                              WORD timeout);
```

##### Parameters

handle	handle returned by previous call to MVI69_Open
buffer	pointer to buffer to receive message data from processor
length	pointer to variable containing the maximum message length in words. When this function is called, this should be set to the size of the indicated buffer. Upon successful return, this variable will contain the actual received message length.
timeout	maximum number of milliseconds to wait for message

##### Description

This function retrieves a message sent from the control processor.

*handle* must be a valid handle returned from MVI69\_Open.

Upon calling this function, *length* should contain the maximum message size in words to be received. *buffer* must point to a buffer of at least *length* words in size. Upon successful return, *length* will contain the actual length of the message received.

If *length* exceeds the maximum message size specified by the value `MsgRcvBufSize` (see the MVI69\_GetIOConfig function), `MVI69_ERR_BADPARAM` will be returned.

*timeout* specifies the number of milliseconds that the function will wait for a message. To poll for a message without waiting, set *timeout* to zero. If no message has been received, `MVI69_ERR_TIMEOUT` will be returned.

If the message received from the control processor is larger than *length*, the message will be truncated to *length* words and `MVI69_ERR_MSGTOOBIG` will be returned.

If the call returns `MVI69_SUCCESS`, *buffer* will contain the message in the following format:

Name	Data Type	Description
MessageId	WORD	Message ID. Used to match responses to requests.
SizeofMessage	WORD	Size of the Message data in bytes.
Message[...]	BYTES	CIP Message packet, starting with Service Code. Total number of bytes is provided in the SizeofMessage field.

The API does not act upon any data of the Message, nor does it monitor response timeouts. The user application is responsible for parsing the message and generating a response.

The API can queue up to 8 requests and they remain queued after the message is given to the user application. The user application must generate a response in order to free the message from the queue.

### Return Value

MVI69_SUCCESS	a message has been received.
MVI69_ERR_NOACCESS	handle does not have access
MVI69_ERR_TIMEOUT	the timeout occurred before a message was received
MVI69_ERR_BADPARAM	a parameter is invalid
MVI69_ERR_BADCONFIG	receive messaging is not enabled

### Example

```
MVI69HANDLE handle;
int rc;
WORD buffer[250]
WORD length;

length = 250; //maximum message size that can be received
//wait up to 5 seconds for a message
rc = MVI69_GetMsgRequestFromBp (Handle, buffer, &length, 5000);
if (rc == MVI69_SUCCESS)
    printf ("Message received. Length is %d words\n", length);
```

### See Also

MVI69\_GetIOConfig

MVI69\_SendMsgResponseToBp

---

## MVI69\_SendMsgResponseToBp

---

### Syntax

```
int MVI69_SendMsgResponseToBp (MVI69HANDLE handle,  
                               WORD *buffer,  
                               WORD *length,  
                               WORD reserved,  
                               WORD timeout);
```

### Parameters

handle	handle returned by previous call to MVI69_Open
buffer	pointer to buffer to send to processor
length	the length in words of the message to send
timeout	maximum number of milliseconds to wait to send message

### Description

This function sends a response to the control processor.

*handle* must be a valid handle returned from MVI69\_Open.

Upon calling this function, *length* should contain the response size in words. *buffer* must point to a buffer of at least *length* words in size.

If *length* exceeds the maximum response size specified by the value *MsgSndBufSize* (see the MVI69\_GetIOConfig function), MVI69\_ERR\_BADPARAM will be returned.

When this function is called, the buffers data must contain the message in the following format:

Name	Data Type	Description
MessageId	WORD	Must echo MessageID of request
SizeofMessage	WORD	Size of the Message data in bytes.
Message[...]	BYTE's	CIP Response packet, starting with Service Response. Total number of bytes is provided in the SizeofMessage field.

The API uses the *MessageId* field to match responses to requests from the backplane. Once the API matches a response to its request, the response will be forwarded to the backplane and the original request can be released.

The API does not act upon any data of the *Message*.

Since the API maintains an internal queue of 8 messages, the user application must generate responses to allow reception of more than 8 messages. If 8 requests are queued and the API receives another request, it will be dropped.

If the *SizeofMessage* field is set to 0, the original request is released and no response is sent to the backplane. This allows the user application to flush messages.

## Return Value

MVI69_SUCCESS	a message has been received.
MVI69_ERR_NOACCESS	handle does not have access
MVI69_ERR_BADPARAM	a parameter is invalid
MVI69_ERR_BADCONFIG	send messaging is not enabled

## Example

```
MVI69HANDLE handle;  
int rc;  
WORD buffer[250];  
  
//wait 5 seconds for the message to be sent  
rc = MVI69_SendMsgResponseToBp (Handle, buffer, 250);  
if (rc == MVI69_SUCCESS)  
    printf ("Message sent\n");
```

## See Also

[MVI69\\_GetIOConfig](#)

[MVI69\\_GetMsgRequestFromBp](#)

## 5.4 Synchronization

### MVI69\_WaitForInputScan

---

#### Syntax

```
int MVI69_WaitForInputScan (MVI69HANDLE handle,  
                           WORD timeout);
```

#### Parameters

handle	handle returned by previous call to MVI69_Open
timeout	maximum number of milliseconds to wait for scan

#### Description

MVI69\_WaitForInputScan allows an application to synchronize with the scan of the module's input image. This function will return immediately after the input image has been read. This function may also be used by a module application to determine if the backplane is active.

*handle* must be a valid handle returned from MVI69\_Open. *timeout* specifies the number of milliseconds that the function will wait for the input scan to occur.

**Note:** There is no distinction in the MVI69E module between input and output scans. Therefore, the MVI69\_WaitForInputScan and MVI69\_WaitForOutputScan functions will perform exactly the same function and are interchangeable.

#### Return Value

MVI69_SUCCESS	the input scan has occurred.
MVI69_ERR_NOACCESS	handle does not have access
MVI69_ERR_TIMEOUT	the timeout expired before an input scan occurred

#### Example

```
MVI69HANDLE handle;  
  
/*wait here until input scan, 50ms timeout */  
rc = MVI69_WaitForInputScan (Handle, 50);  
if (rc == MVI69_ERR_TIMEOUT)  
    printf ("Message scan did not occur within 50 milliseconds\n");  
else  
    printf ("Input scan has occurred\n");
```

#### See Also

MVI69\_WaitForOutputScan



---

## MVI69\_WaitForOutputScan

---

### Syntax

```
int MVI69_WaitForOutputScan (MVI69HANDLE handle,  
                             WORD timeout);
```

### Parameters

handle	handle returned by previous call to MVI69_Open
timeout	maximum number of milliseconds to wait for scan

### Description

MVI69\_WaitForOutputScan allows an application to synchronize with the scan of the module's output image. This function will return immediately after the module's output image has been written.

*handle* must be a valid handle returned from MVI69\_Open. *timeout* specifies the number of milliseconds that the function will wait for the output scan to occur.

**Note:** There is no distinction in the MVI69E module between input and output scans. Therefore, the MVI69\_WaitForInputScan and MVI69\_WaitForOutputScan functions will perform exactly the same function and are interchangeable.

### Return Value

MVI69_SUCCESS	the output scan has occurred.
MVI69_ERR_NOACCESS	handle does not have access
MVI69_ERR_TIMEOUT	the timeout expired before an output scan occurred

### Example

```
MVI69HANDLE handle;  
int rc;  
  
/*wait here until output scan, 50ms timeout */  
rc = MVI69_WaitForOutputScan (Handle, 50);  
if (rc == MVI69_ERR_TIMEOUT)  
    printf ("Output scan did not occur within 50 milliseconds\n");  
else  
    printf ("Output scan has occurred\n");
```

### See Also

MVI69\_WaitForInputScan

## 5.5 Serial Ports

The API functions in this section can be used to access tag data withing CompactLogix controllers. The prototypes for most of these functions and their associated data structure definitions can be found in the header file OCXTagDb.h.

The tag access functions that include "Db" in the name are for use with a valid tag database (see *OCXcip\_BuildTagDb* ).

### MVI69\_GetSerialConfig

---

#### Syntax

```
int MVI69_GetSerialConfig (MVI69HANDLE handle,  
                           MVI69SPCONFIG *spconfig);
```

#### Parameters

handle	handle returned by previous call to MVI69_Open
spconfig	pointer to structure of type MVI69SPCONFIG

#### Description

MVI69\_GetSerialConfig retrieves the state of the serial port configuration jumper for the port specified. The information is returned in the structure spconfig.

*handle* must be a valid handle returned from MVI69\_Open.

The MVI69SPCONFIG structure is defined as follows:

```
typedef struct tagMVI69SPCONFIG  
{  
    int port_num;        /* Port number (1 or 2) */  
    int port_cfg;       /* Jumper position */  
} MVI69SPCONFIG;
```

port\_num must be set to the desired port before calling this function. Upon return, port\_cfg will be set to one of the following values:

MVI69\_SERIAL\_CONFIG\_NONE (No jumper installed)

MVI69\_SERIAL\_CONFIG\_RS-232

MVI69\_SERIAL\_CONFIG\_RS-422

MVI69\_SERIAL\_CONFIG\_RS-485

#### Return Value

MVI69_SUCCESS	the configuration information was read successfully
MVI69_ERR_NOACCESS	handle does not have access

### Example

```
MVI69HANDLE      handle;
MVI69SPCONFIG    spconfig;

/*Get jumper setting for Port 2 and verify that it is RS-232*/
spconfig.port_num = 2
MVI69_GetSerialConfig (Handle, &spconfig);
if (spconfig.port_cfg != MVI69_SERIAL_CONFIG_RS232)
    printf ("Port 2 is not configured for RS-232");
```

### See Also

[MVI69\\_SetSerialConfig](#)

## MVI69\_SetSerialConfig

---

### Syntax

```
int MVI69_SetSerialConfig (MVI69HANDLE handle,  
                           MVI69SPCONFIG *spconfig);
```

### Parameters

handle	handle returned by previous call to MVI69_Open
spconfig	pointer to structure of type MVI69SPCONFIG

### Description

MVI69\_SetSerialConfig sets the serial port configuration. This function overrides the serial port configuration jumper setting. The port number and configuration are specified in the structure spconfig.

*handle* must be a valid handle returned from MVI69\_Open.

The MVI69SPCONFIG structure is defined as follows:

```
typedef struct tagMVI69SPCONFIG  
{  
    int port_num;      /* Port number (1 or 2) */  
    int port_cfg;     /* Jumper position */  
} MVI69SPCONFIG;
```

### Return Value

MVI69_SUCCESS	the configuration information was read successfully
MVI69_ERR_NOACCESS	handle does not have access

### Example

```
MVI69HANDLE    handle;  
MVI69SPCONFIG  spconfig;  
  
/* Set up port 2 for RS-232*/  
spconfig.port_num = 2;  
spconfig.port_cfg = MVI69_SERIAL_CONFIG_RS232;  
MVI69_SetSerialConfig (Handle, &spconfig);
```

### See Also

MVI69\_GetSerialConfig

## 5.6 Miscellaneous Functions

### MVI69\_GetVersionInfo

---

#### Syntax

```
int MVI69_GetVersionInfo (MVI69HANDLE handle,
                        MVI69VERSIONINFO *verinfo);
```

#### Parameters

handle	handle returned by previous call to MVI69_Open
verinfo	pointer to structure of type MVI69VERSIONINFO

#### Description

MVI69\_GetVersionInfo retrieves the current version of the API library and the backplane device driver. This information is returned in the structure verinfo.

*handle* must be a valid handle returned from MVI69\_Open.

The MVI69VERSIONINFO structure is defined as follows:

```
typedef struct tagMVI69VERSIONINFO
{
    WORD  APISeries;      /* API series */
    WORD  APIRevision;   /* API revision */
    WORD  DDSeries;      /* Device driver series */
    WORD  DDRevision;    /* Device driver revision */
} MVI69VERSIONINFO
```

#### Return Value

MVI69_SUCCESS	the version information was read successfully
MVI69_ERR_NOACCESS	handle does not have access

#### Example

```
MVI69HANDLE      handle;
MVI69VERSIONINFO verinfo;

/* print version of API library and driver */
MVI69_GetVersionInfo (handle, &verinfo);
printf("Library Series %d, Rev %d\n", verinfo.APISeries, verinfo.APIRevision);
printf("Driver Series %d, Rev %d\n", verinfo.DDSeries, verinfo.DDRevision);
```

---

## MVI69\_GetModuleInfo

---

### Syntax

```
int MVI69_GetModuleInfo (MVI69HANDLE handle,  
                        MVI69MODULEINFO *modinfo);
```

### Parameters

handle	handle returned by previous call to MVI69_Open
modinfo	pointer to structure of type MVI69MODULEINFO

### Description

MVI69\_GetModuleInfo retrieves identity information for the module. This information is returned in the structure modinfo.

*handle* must be a valid handle returned from MVI69\_Open.

The MVI69MODULEINFO structure is defined as follows:

```
typedef struct tagMVI69MODULEINFO  
{  
    WORD  VendorID;          /* Reserved */  
    WORD  DeviceType;       /* Reserved */  
    WORD  ProductCode;      /* Device model code */  
    BYTE  MajorRevision;    /* Device major revision */  
    BYTE  MinorRevision;    /* Device minor revision */  
    DWORD SerialNo;         /* Serial number */  
    BYTE  Name[32];         /* Device name (string) */  
} MVI69MODULEINFO
```

### Return Value

MVI69_SUCCESS	the module information was read successfully
MVI69_ERR_NOACCESS	handle does not have access

### Example

```
MVI69HANDLE      handle;  
MVI69MODULEINFO modinfo;  
  
/* print module name */  
MVI69_GetModuleInfo (handle, &modinfo);  
printf("Name is %s\n", modinfo.Name);
```

### See Also

MVI69\_SetModuleInfo

## MVI69\_SetModuleInfo

### Syntax

```
int MVI69_SetModuleInfo (MVI69HANDLE handle,
                        MVI69MODULEINFO *modinfo);
```

### Parameters

handle	not used - set to 0
modinfo	pointer to structure of type MVI69MODULEINFO

### Description

MVI69\_SetModuleInfo sets the identity information for the module. This function must be called before MVI69\_Open. The module identity is provided in the structure modinfo. *handle* must be a valid handle returned from MVI69\_Open. The MVI69MODULEINFO structure is defined as:

```
typedef struct tagMVIBPMODULEINFO
{
    WORD  VendorID;          /* Reserved */
    WORD  DeviceType;       /* Reserved */
    WORD  ProductCode;      /* Device model code */
    BYTE  MajorRevision;    /* Device major revision */
    BYTE  MinorRevision;    /* Device minor revision */
    DWORD SerialNo;         /* Serial number */
    BYTE  Name[32];         /* Device name (string) */
} MVI69MODULEINFO
```

The module serial number is set during manufacturing and cannot be edited.

### Return Value

MVI69_SUCCESS	the module information was read successfully
MVI69_ERR_NOACCESS	handle does not have access

### Example

```
MVI69HANDLE      handle;
MVIBPMODULEINFO  modinfo;

/* Setup a customized module identity */
char new_name[] = "Widget 6900";
strcpy (modinfo.Name, new_name);
modinfo.VendorID = 774;
modinfo.DeviceType = 30;
modinfo.ProductCode = 42;
modinfo.MajorRevision = 2;
modinfo.MinorRevision = 1;
MVI69_SetModuleInfo (0, &modinfo);
/* Now open the API (and initialize backplane comms with new ID) */
MVI69_Open (&Handle);
```

### See Also

MVI69\_GetModuleInfo

---

## MVI69\_GetScanMode

---

### Syntax

```
int MVI69_GetScanMode (MVI69HANDLE handle, int *mode);
```

### Parameters

handle	handle returned by previous call to MVI69_Open
mode	pointer to a variable that will be updated with the current processor mode

### Description

This function is used to query the state of the processor.

*handle* must be a valid handle returned from MVI69\_Open.

*mode* is a pointer to an integer. When this function returns, this will be set to indicate the current processor status and shown in the following table:

Name	Description
MVI69_RUN_MODE	Set if processor is in Run mode.
MVI69_PROGRAM_MODE	Set if processor is in Program Mode.

### Return Value

MVI69_SUCCESS	no errors were encountered
MVI69_ERR_NOACCESS	handle does not have access

### Example

```
MVI69HANDLE      handle;  
int              status;  
  
MVI69_GetProcessorStatus (handle, &status);  
if (status == MVI69_RUN_MODE)  
    //Processor is in Run Mode  
else  
    //Processor is not in Run Mode
```



---

## MVI69\_GetScanCounter

---

### Syntax

```
int MVI69_GetScanCounter (MVI69HANDLE handle, DWORD *count);
```

### Parameters

<code>handle</code>	handle returned by previous call to <code>MVI69_Open</code>
<code>count</code>	pointer to a variable that will be updated with the current scan count

### Description

This function returns the current scan counter. The scan counter is a 32-bit counter that is incremented with each backplane scan.

*handle* must be a valid handle returned from `MVI69_Open`.

### Return Value

<code>MVI69_SUCCESS</code>	no errors were encountered
<code>MVI69_ERR_NOACCESS</code>	<i>handle</i> does not have access

### Example

```
MVI69HANDLE    handle;  
DWORD          scancount;  
  
MVI69_GetScanCounter (handle, &scancount);
```

## MVI69\_SetLED

---

### Syntax

```
int MVI69_SetLED (MVI69HANDLE handle, int lednum, int ledstate);
```

### Parameters

handle	handle returned by previous call to MVI69_Open
lednum	Specifies which of the user LED indicators is being addressed.
ledstate	Specifies the state to set

### Description

MVI69\_SetLED allows an application to set the state of the LED indicators.

*handle* must be a valid handle returned from MVI69\_Open.

*lednum* must be set to MVI69\_LEDID\_OK, MVI69\_LEDID\_CFG, MVI69\_LEDID\_P1, MVI69\_LEDID\_P2, MVI69\_LEDID\_BP, or MVI69\_LEDID\_NET.

*ledstate* must be set to MVI69\_LED\_STATE\_RED, MVI69\_LED\_STATE\_GREEN, MVI69\_LED\_STATE\_YELLOW, or MVI69\_LED\_STATE\_OFF.

### Return Value

MVI69_SUCCESS	the LED state has been set
MVI69_ERR_NOACCESS	handle does not have access
MVI69_ERR_BADPARAM	lednum or ledstate is invalid

### Example

```
MVI69HANDLE          handle;  
  
/* OK LED green and NET LED yellow */  
MVI69_SetLED(Handle, MVI69_LEDID_OK, MVI69_LED_STATE_GREEN);  
MVI69_SetLED(Handle, MVI69_LEDID_NET, MVI69_LED_STATE_YELLOW);
```

---

## MVI69\_GetSetupJumper

---

### Syntax

```
int MVI69_GetSetupJumper (MVI69HANDLE handle, int *mode);
```

### Parameters

handle	handle returned by previous call to MVI69_Open
mode	Pointer to an integer that is set to 1 if the Setup Jumper is installed, or 0 if the Setup Jumper is not installed.

### Description

This function is used to query the state of the Setup Jumper.

handle must be a valid handle returned from MVI69\_Open.

mode is a pointer to an integer. When this function returns, mode will be set to 1 if the module is in setup mode, or 0 if not.

If the Setup Jumper is installed, the module is considered to be in Setup Mode. It may be useful for an application to detect Setup Mode and perform special configuration or diagnostic functions.

### Return Value

MVI69_SUCCESS	no errors were encountered
MVI69_ERR_NOACCESS	handle does not have access

### Example

```
MVI69HANDLE    handle;  
int            mode;  
  
MVI69_GetSetupMode (handle, &mode);  
if (mode)  
    // Setup jumper is installed - perform configuration/diagnostic  
else  
    // Not in Setup Mode - normal operation
```

## 6 Cable Connections

The application ports on the MVI69E-LDM module support RS-232, RS-422, and RS-485 interfaces. Please inspect the module to ensure that the jumpers are set correctly to correspond with the type of interface you are using.

**Note:** When using RS-232 with radio modem applications, some radios or modems require hardware handshaking (control and monitoring of modem signal lines). Enable this in the configuration of the module by setting the *UseCTS* parameter to 1.

### 6.1 RS-232 Configuration/Debug Port

This port is physically an RJ45 connection. An RJ45 to DB-9 adapter cable is included with the module. This port permits a PC-based terminal emulation program to view configuration and status data in the module and to control the module. The cable pinout for communications on this port is shown in the following diagram.

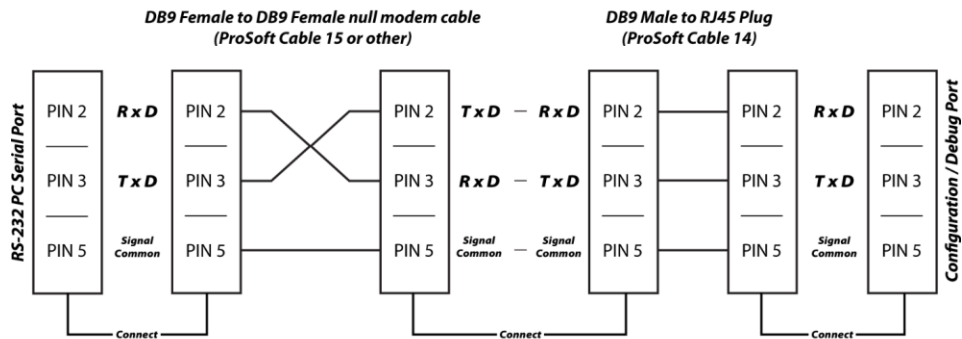

## 6.2 RS-232 Application Port(s)

When the RS-232 interface is selected, the use of hardware handshaking (control and monitoring of modem signal lines) is user definable. If no hardware handshaking will be used, here are the cable pinouts to connect to the port.

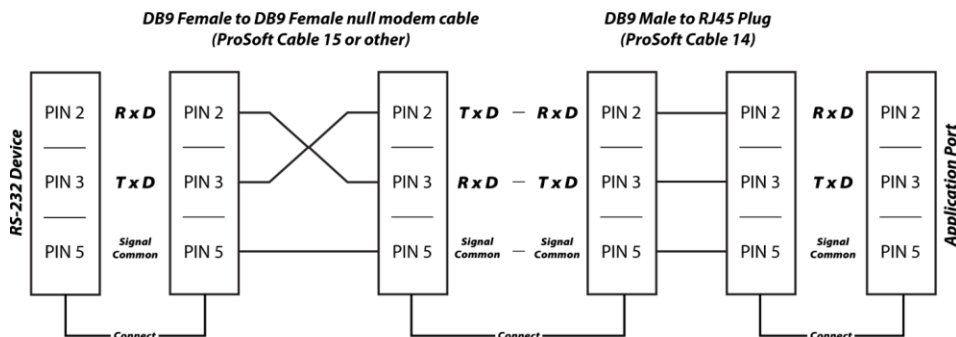

### 6.2.1 RS-232: Modem Connection (Hardware Handshaking Required)

This type of connection is required between the module and a modem or other communication device.

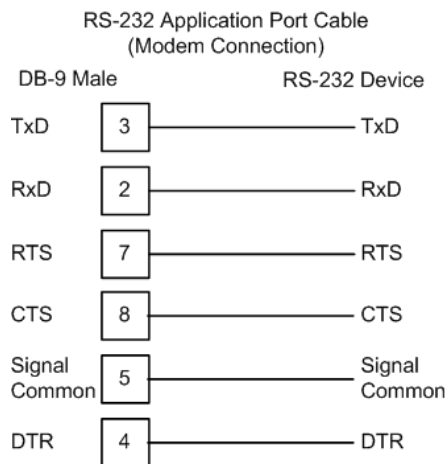

The *Use CTS Line* parameter for the port configuration should be set to **Y** for most modem applications.

### 6.2.2 RS-232: Null Modem Connection (Hardware Handshaking)

This type of connection is used when the device connected to the module requires hardware handshaking (control and monitoring of modem signal lines).

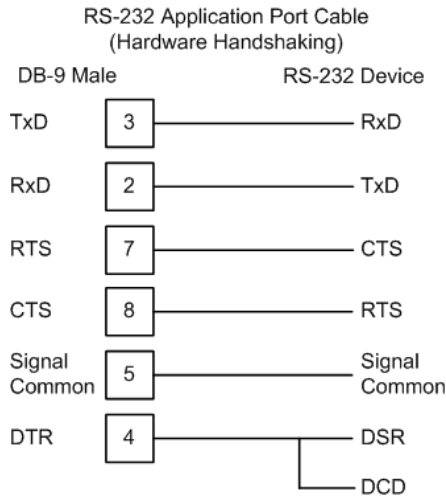

### 6.2.3 RS-232: Null Modem Connection (No Hardware Handshaking)

This type of connection can be used to connect the module to a computer or field device communication port.

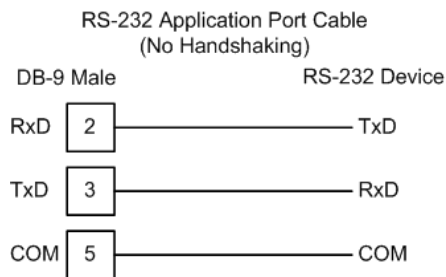

**Note:** For most null modem connections where hardware handshaking is not required, the *Use CTS Line* parameter should be set to **N** and no jumper will be required between Pins 7 (RTS) and 8 (CTS) on the connector. If the port is configured with the *Use CTS Line* set to **Y**, then a jumper is required between the RTS and the CTS lines on the port connection.

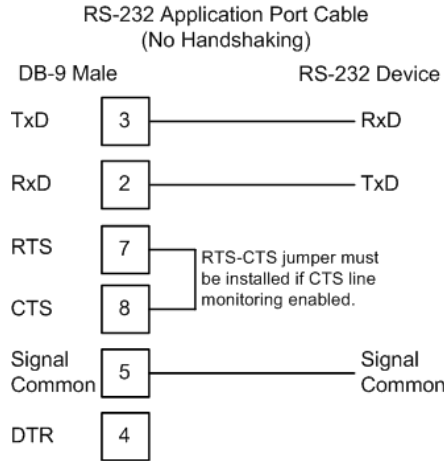

### 6.3 RS-422

The RS-422 interface requires a single four or five wire cable. The Common connection is optional, depending on the RS-422 network devices used. The cable required for this interface is shown below:

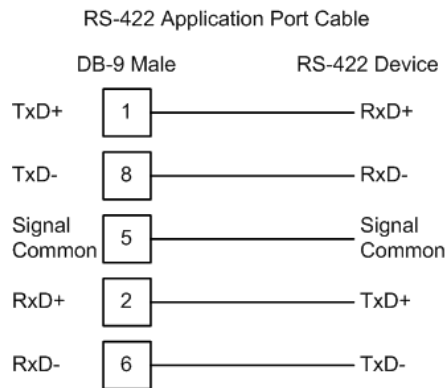

### 6.4 RS-485 Application Port(s)

The RS-485 interface requires a single two or three wire cable. The Common connection is optional, depending on the RS-485 network devices used. The cable required for this interface is shown below:

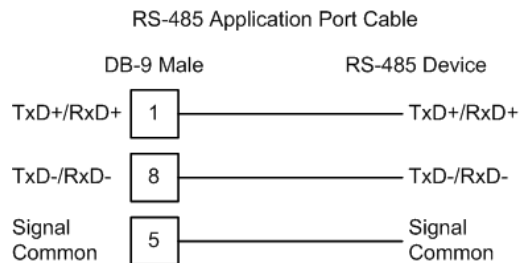

**Note:** Terminating resistors are generally not required on the RS-485 network, unless you are experiencing communication problems that can be attributed to signal echoes or reflections. In these cases, installing a 120-ohm terminating resistor between pins 1 and 8 on the module connector end of the RS-485 line may improve communication quality.

### 6.4.1 RS-485 and RS-422 Tip

If communication in the RS-422 or RS-485 mode does not work at first, despite all attempts, try switching termination polarities. Some manufacturers interpret + and -, or A and B, polarities differently.

## 6.5 DB9 to RJ45 Adaptor (Cable 14)

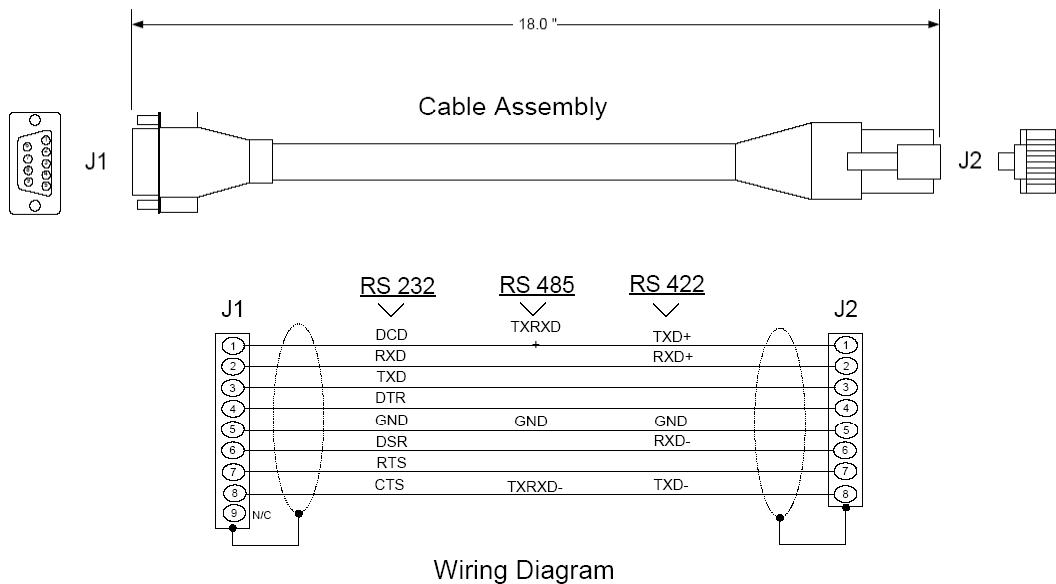



## 7 Open Source Licensing

This module utilizes Open Source applications, available under the GNU Public License and others. The following sections cover all Open Source licensing:

- GNU Public License
- Eclipse
- Python
- Debian
- GCC

## 7.1 GNU Public License

GNU GENERAL PUBLIC LICENSE

Version 3, 29 June 2007

Copyright (C) 2007 Free Software Foundation, Inc. <<http://fsf.org/>>  
Everyone is permitted to copy and distribute verbatim copies  
of this license document, but changing it is not allowed.

### Preamble

The GNU General Public License is a free, copyleft license for software and other kinds of works.

The licenses for most software and other practical works are designed to take away your freedom to share and change the works. By contrast, the GNU General Public License is intended to guarantee your freedom to share and change all versions of a program--to make sure it remains free software for all its users. We, the Free Software Foundation, use the GNU General Public License for most of our software; it applies also to any other work released this way by its authors. You can apply it to your programs, too.

When we speak of free software, we are referring to freedom, not price. Our General Public Licenses are designed to make sure that you have the freedom to distribute copies of free software (and charge for them if you wish), that you receive source code or can get it if you want it, that you can change the software or use pieces of it in new free programs, and that you know you can do these things.

To protect your rights, we need to prevent others from denying you these rights or asking you to surrender the rights. Therefore, you have certain responsibilities if you distribute copies of the software, or if you modify it: responsibilities to respect the freedom of others.

For example, if you distribute copies of such a program, whether gratis or for a fee, you must pass on to the recipients the same freedoms that you received. You must make sure that they, too, receive or can get the source code. And you must show them these terms so they know their rights.

Developers that use the GNU GPL protect your rights with two steps: (1) assert copyright on the software, and (2) offer you this License giving you legal permission to copy, distribute and/or modify it.

For the developers' and authors' protection, the GPL clearly explains that there is no warranty for this free software. For both users' and authors' sake, the GPL requires that modified versions be marked as changed, so that their problems will not be attributed erroneously to authors of previous versions.

Some devices are designed to deny users access to install or run modified versions of the software inside them, although the manufacturer can do so. This is fundamentally incompatible with the aim of protecting users' freedom to change the software. The systematic pattern of such abuse occurs in the area of products for individuals to

use, which is precisely where it is most unacceptable. Therefore, we have designed this version of the GPL to prohibit the practice for those products. If such problems arise substantially in other domains, we stand ready to extend this provision to those domains in future versions of the GPL, as needed to protect the freedom of users.

Finally, every program is threatened constantly by software patents. States should not allow patents to restrict development and use of software on general-purpose computers, but in those that do, we wish to avoid the special danger that patents applied to a free program could make it effectively proprietary. To prevent this, the GPL assures that patents cannot be used to render the program non-free.

The precise terms and conditions for copying, distribution and modification follow.

#### TERMS AND CONDITIONS

##### 0. Definitions.

"This License" refers to version 3 of the GNU General Public License.

"Copyright" also means copyright-like laws that apply to other kinds of works, such as semiconductor masks.

"The Program" refers to any copyrightable work licensed under this License. Each licensee is addressed as "you". "Licensees" and "recipients" may be individuals or organizations.

To "modify" a work means to copy from or adapt all or part of the work in a fashion requiring copyright permission, other than the making of an exact copy. The resulting work is called a "modified version" of the earlier work or a work "based on" the earlier work.

A "covered work" means either the unmodified Program or a work based on the Program.

To "propagate" a work means to do anything with it that, without permission, would make you directly or secondarily liable for infringement under applicable copyright law, except executing it on a computer or modifying a private copy. Propagation includes copying, distribution (with or without modification), making available to the public, and in some countries other activities as well.

To "convey" a work means any kind of propagation that enables other parties to make or receive copies. Mere interaction with a user through a computer network, with no transfer of a copy, is not conveying.

An interactive user interface displays "Appropriate Legal Notices" to the extent that it includes a convenient and prominently visible feature that (1) displays an appropriate copyright notice, and (2) tells the user that there is no warranty for the work (except to the extent that warranties are provided), that licensees may convey the work under this License, and how to view a copy of this License. If the interface presents a list of user commands or options, such as a menu, a prominent item in the list meets this criterion.

## 1. Source Code.

The "source code" for a work means the preferred form of the work for making modifications to it. "Object code" means any non-source form of a work.

A "Standard Interface" means an interface that either is an official standard defined by a recognized standards body, or, in the case of interfaces specified for a particular programming language, one that is widely used among developers working in that language.

The "System Libraries" of an executable work include anything, other than the work as a whole, that (a) is included in the normal form of packaging a Major Component, but which is not part of that Major Component, and (b) serves only to enable use of the work with that Major Component, or to implement a Standard Interface for which an implementation is available to the public in source code form. A "Major Component", in this context, means a major essential component (kernel, window system, and so on) of the specific operating system (if any) on which the executable work runs, or a compiler used to produce the work, or an object code interpreter used to run it.

The "Corresponding Source" for a work in object code form means all the source code needed to generate, install, and (for an executable work) run the object code and to modify the work, including scripts to control those activities. However, it does not include the work's System Libraries, or general-purpose tools or generally available free programs which are used unmodified in performing those activities but which are not part of the work. For example, Corresponding Source includes interface definition files associated with source files for the work, and the source code for shared libraries and dynamically linked subprograms that the work is specifically designed to require, such as by intimate data communication or control flow between those subprograms and other parts of the work.

The Corresponding Source need not include anything that users can regenerate automatically from other parts of the Corresponding Source.

The Corresponding Source for a work in source code form is that same work.

## 2. Basic Permissions.

All rights granted under this License are granted for the term of copyright on the Program, and are irrevocable provided the stated conditions are met. This License explicitly affirms your unlimited permission to run the unmodified Program. The output from running a covered work is covered by this License only if the output, given its content, constitutes a covered work. This License acknowledges your rights of fair use or other equivalent, as provided by copyright law.

You may make, run and propagate covered works that you do not convey, without conditions so long as your license otherwise remains in force. You may convey covered works to others for the sole purpose

of having them make modifications exclusively for you, or provide you with facilities for running those works, provided that you comply with the terms of this License in conveying all material for which you do not control copyright. Those thus making or running the covered works for you must do so exclusively on your behalf, under your direction and control, on terms that prohibit them from making any copies of your copyrighted material outside their relationship with you.

Conveying under any other circumstances is permitted solely under the conditions stated below. Sublicensing is not allowed; section 10 makes it unnecessary.

### 3. Protecting Users' Legal Rights From Anti-Circumvention Law.

No covered work shall be deemed part of an effective technological measure under any applicable law fulfilling obligations under article 11 of the WIPO copyright treaty adopted on 20 December 1996, or similar laws prohibiting or restricting circumvention of such measures.

When you convey a covered work, you waive any legal power to forbid circumvention of technological measures to the extent such circumvention is effected by exercising rights under this License with respect to the covered work, and you disclaim any intention to limit operation or modification of the work as a means of enforcing, against the work's users, your or third parties' legal rights to forbid circumvention of technological measures.

### 4. Conveying Verbatim Copies.

You may convey verbatim copies of the Program's source code as you receive it, in any medium, provided that you conspicuously and appropriately publish on each copy an appropriate copyright notice; keep intact all notices stating that this License and any non-permissive terms added in accord with section 7 apply to the code; keep intact all notices of the absence of any warranty; and give all recipients a copy of this License along with the Program.

You may charge any price or no price for each copy that you convey, and you may offer support or warranty protection for a fee.

### 5. Conveying Modified Source Versions.

You may convey a work based on the Program, or the modifications to produce it from the Program, in the form of source code under the terms of section 4, provided that you also meet all of these conditions:

- a) The work must carry prominent notices stating that you modified it, and giving a relevant date.
- b) The work must carry prominent notices stating that it is released under this License and any conditions added under section 7. This requirement modifies the requirement in section 4 to "keep intact all notices".
- c) You must license the entire work, as a whole, under this

License to anyone who comes into possession of a copy. This License will therefore apply, along with any applicable section 7 additional terms, to the whole of the work, and all its parts, regardless of how they are packaged. This License gives no permission to license the work in any other way, but it does not invalidate such permission if you have separately received it.

d) If the work has interactive user interfaces, each must display Appropriate Legal Notices; however, if the Program has interactive interfaces that do not display Appropriate Legal Notices, your work need not make them do so.

A compilation of a covered work with other separate and independent works, which are not by their nature extensions of the covered work, and which are not combined with it such as to form a larger program, in or on a volume of a storage or distribution medium, is called an "aggregate" if the compilation and its resulting copyright are not used to limit the access or legal rights of the compilation's users beyond what the individual works permit. Inclusion of a covered work in an aggregate does not cause this License to apply to the other parts of the aggregate.

#### 6. Conveying Non-Source Forms.

You may convey a covered work in object code form under the terms of sections 4 and 5, provided that you also convey the machine-readable Corresponding Source under the terms of this License, in one of these ways:

a) Convey the object code in, or embodied in, a physical product (including a physical distribution medium), accompanied by the Corresponding Source fixed on a durable physical medium customarily used for software interchange.

b) Convey the object code in, or embodied in, a physical product (including a physical distribution medium), accompanied by a written offer, valid for at least three years and valid for as long as you offer spare parts or customer support for that product model, to give anyone who possesses the object code either (1) a copy of the Corresponding Source for all the software in the product that is covered by this License, on a durable physical medium customarily used for software interchange, for a price no more than your reasonable cost of physically performing this conveying of source, or (2) access to copy the Corresponding Source from a network server at no charge.

c) Convey individual copies of the object code with a copy of the written offer to provide the Corresponding Source. This alternative is allowed only occasionally and noncommercially, and only if you received the object code with such an offer, in accord with subsection 6b.

d) Convey the object code by offering access from a designated place (gratis or for a charge), and offer equivalent access to the Corresponding Source in the same way through the same place at no further charge. You need not require recipients to copy the

Corresponding Source along with the object code. If the place to copy the object code is a network server, the Corresponding Source may be on a different server (operated by you or a third party) that supports equivalent copying facilities, provided you maintain clear directions next to the object code saying where to find the Corresponding Source. Regardless of what server hosts the Corresponding Source, you remain obligated to ensure that it is available for as long as needed to satisfy these requirements.

e) Convey the object code using peer-to-peer transmission, provided you inform other peers where the object code and Corresponding Source of the work are being offered to the general public at no charge under subsection 6d.

A separable portion of the object code, whose source code is excluded from the Corresponding Source as a System Library, need not be included in conveying the object code work.

A "User Product" is either (1) a "consumer product", which means any tangible personal property which is normally used for personal, family, or household purposes, or (2) anything designed or sold for incorporation into a dwelling. In determining whether a product is a consumer product, doubtful cases shall be resolved in favor of coverage. For a particular product received by a particular user, "normally used" refers to a typical or common use of that class of product, regardless of the status of the particular user or of the way in which the particular user actually uses, or expects or is expected to use, the product. A product is a consumer product regardless of whether the product has substantial commercial, industrial or non-consumer uses, unless such uses represent the only significant mode of use of the product.

"Installation Information" for a User Product means any methods, procedures, authorization keys, or other information required to install and execute modified versions of a covered work in that User Product from a modified version of its Corresponding Source. The information must suffice to ensure that the continued functioning of the modified object code is in no case prevented or interfered with solely because modification has been made.

If you convey an object code work under this section in, or with, or specifically for use in, a User Product, and the conveying occurs as part of a transaction in which the right of possession and use of the User Product is transferred to the recipient in perpetuity or for a fixed term (regardless of how the transaction is characterized), the Corresponding Source conveyed under this section must be accompanied by the Installation Information. But this requirement does not apply if neither you nor any third party retains the ability to install modified object code on the User Product (for example, the work has been installed in ROM).

The requirement to provide Installation Information does not include a requirement to continue to provide support service, warranty, or updates for a work that has been modified or installed by the recipient, or for the User Product in which it has been modified or installed. Access to a network may be denied when the modification itself materially and adversely affects the operation of the network or violates the rules and

protocols for communication across the network.

Corresponding Source conveyed, and Installation Information provided, in accord with this section must be in a format that is publicly documented (and with an implementation available to the public in source code form), and must require no special password or key for unpacking, reading or copying.

#### 7. Additional Terms.

"Additional permissions" are terms that supplement the terms of this License by making exceptions from one or more of its conditions. Additional permissions that are applicable to the entire Program shall be treated as though they were included in this License, to the extent that they are valid under applicable law. If additional permissions apply only to part of the Program, that part may be used separately under those permissions, but the entire Program remains governed by this License without regard to the additional permissions.

When you convey a copy of a covered work, you may at your option remove any additional permissions from that copy, or from any part of it. (Additional permissions may be written to require their own removal in certain cases when you modify the work.) You may place additional permissions on material, added by you to a covered work, for which you have or can give appropriate copyright permission.

Notwithstanding any other provision of this License, for material you add to a covered work, you may (if authorized by the copyright holders of that material) supplement the terms of this License with terms:

- a) Disclaiming warranty or limiting liability differently from the terms of sections 15 and 16 of this License; or
- b) Requiring preservation of specified reasonable legal notices or author attributions in that material or in the Appropriate Legal Notices displayed by works containing it; or
- c) Prohibiting misrepresentation of the origin of that material, or requiring that modified versions of such material be marked in reasonable ways as different from the original version; or
- d) Limiting the use for publicity purposes of names of licensors or authors of the material; or
- e) Declining to grant rights under trademark law for use of some trade names, trademarks, or service marks; or
- f) Requiring indemnification of licensors and authors of that material by anyone who conveys the material (or modified versions of it) with contractual assumptions of liability to the recipient, for any liability that these contractual assumptions directly impose on those licensors and authors.

All other non-permissive additional terms are considered "further restrictions" within the meaning of section 10. If the Program as you received it, or any part of it, contains a notice stating that it is



governed by this License along with a term that is a further restriction, you may remove that term. If a license document contains a further restriction but permits relicensing or conveying under this License, you may add to a covered work material governed by the terms of that license document, provided that the further restriction does not survive such relicensing or conveying.

If you add terms to a covered work in accord with this section, you must place, in the relevant source files, a statement of the additional terms that apply to those files, or a notice indicating where to find the applicable terms.

Additional terms, permissive or non-permissive, may be stated in the form of a separately written license, or stated as exceptions; the above requirements apply either way.

#### 8. Termination.

You may not propagate or modify a covered work except as expressly provided under this License. Any attempt otherwise to propagate or modify it is void, and will automatically terminate your rights under this License (including any patent licenses granted under the third paragraph of section 11).

However, if you cease all violation of this License, then your license from a particular copyright holder is reinstated (a) provisionally, unless and until the copyright holder explicitly and finally terminates your license, and (b) permanently, if the copyright holder fails to notify you of the violation by some reasonable means prior to 60 days after the cessation.

Moreover, your license from a particular copyright holder is reinstated permanently if the copyright holder notifies you of the violation by some reasonable means, this is the first time you have received notice of violation of this License (for any work) from that copyright holder, and you cure the violation prior to 30 days after your receipt of the notice.

Termination of your rights under this section does not terminate the licenses of parties who have received copies or rights from you under this License. If your rights have been terminated and not permanently reinstated, you do not qualify to receive new licenses for the same material under section 10.

#### 9. Acceptance Not Required for Having Copies.

You are not required to accept this License in order to receive or run a copy of the Program. Ancillary propagation of a covered work occurring solely as a consequence of using peer-to-peer transmission to receive a copy likewise does not require acceptance. However, nothing other than this License grants you permission to propagate or modify any covered work. These actions infringe copyright if you do not accept this License. Therefore, by modifying or propagating a covered work, you indicate your acceptance of this License to do so.

#### 10. Automatic Licensing of Downstream Recipients.

Each time you convey a covered work, the recipient automatically receives a license from the original licensors, to run, modify and propagate that work, subject to this License. You are not responsible for enforcing compliance by third parties with this License.

An "entity transaction" is a transaction transferring control of an organization, or substantially all assets of one, or subdividing an organization, or merging organizations. If propagation of a covered work results from an entity transaction, each party to that transaction who receives a copy of the work also receives whatever licenses to the work the party's predecessor in interest had or could give under the previous paragraph, plus a right to possession of the Corresponding Source of the work from the predecessor in interest, if the predecessor has it or can get it with reasonable efforts.

You may not impose any further restrictions on the exercise of the rights granted or affirmed under this License. For example, you may not impose a license fee, royalty, or other charge for exercise of rights granted under this License, and you may not initiate litigation (including a cross-claim or counterclaim in a lawsuit) alleging that any patent claim is infringed by making, using, selling, offering for sale, or importing the Program or any portion of it.

#### 11. Patents.

A "contributor" is a copyright holder who authorizes use under this License of the Program or a work on which the Program is based. The work thus licensed is called the contributor's "contributor version".

A contributor's "essential patent claims" are all patent claims owned or controlled by the contributor, whether already acquired or hereafter acquired, that would be infringed by some manner, permitted by this License, of making, using, or selling its contributor version, but do not include claims that would be infringed only as a consequence of further modification of the contributor version. For purposes of this definition, "control" includes the right to grant patent sublicenses in a manner consistent with the requirements of this License.

Each contributor grants you a non-exclusive, worldwide, royalty-free patent license under the contributor's essential patent claims, to make, use, sell, offer for sale, import and otherwise run, modify and propagate the contents of its contributor version.

In the following three paragraphs, a "patent license" is any express agreement or commitment, however denominated, not to enforce a patent (such as an express permission to practice a patent or covenant not to sue for patent infringement). To "grant" such a patent license to a party means to make such an agreement or commitment not to enforce a patent against the party.

If you convey a covered work, knowingly relying on a patent license, and the Corresponding Source of the work is not available for anyone to copy, free of charge and under the terms of this License, through a publicly available network server or other readily accessible means,

then you must either (1) cause the Corresponding Source to be so available, or (2) arrange to deprive yourself of the benefit of the patent license for this particular work, or (3) arrange, in a manner consistent with the requirements of this License, to extend the patent license to downstream recipients. "Knowingly relying" means you have actual knowledge that, but for the patent license, your conveying the covered work in a country, or your recipient's use of the covered work in a country, would infringe one or more identifiable patents in that country that you have reason to believe are valid.

If, pursuant to or in connection with a single transaction or arrangement, you convey, or propagate by procuring conveyance of, a covered work, and grant a patent license to some of the parties receiving the covered work authorizing them to use, propagate, modify or convey a specific copy of the covered work, then the patent license you grant is automatically extended to all recipients of the covered work and works based on it.

A patent license is "discriminatory" if it does not include within the scope of its coverage, prohibits the exercise of, or is conditioned on the non-exercise of one or more of the rights that are specifically granted under this License. You may not convey a covered work if you are a party to an arrangement with a third party that is in the business of distributing software, under which you make payment to the third party based on the extent of your activity of conveying the work, and under which the third party grants, to any of the parties who would receive the covered work from you, a discriminatory patent license (a) in connection with copies of the covered work conveyed by you (or copies made from those copies), or (b) primarily for and in connection with specific products or compilations that contain the covered work, unless you entered into that arrangement, or that patent license was granted, prior to 28 March 2007.

Nothing in this License shall be construed as excluding or limiting any implied license or other defenses to infringement that may otherwise be available to you under applicable patent law.

#### 12. No Surrender of Others' Freedom.

If conditions are imposed on you (whether by court order, agreement or otherwise) that contradict the conditions of this License, they do not excuse you from the conditions of this License. If you cannot convey a covered work so as to satisfy simultaneously your obligations under this License and any other pertinent obligations, then as a consequence you may not convey it at all. For example, if you agree to terms that obligate you to collect a royalty for further conveying from those to whom you convey the Program, the only way you could satisfy both those terms and this License would be to refrain entirely from conveying the Program.

#### 13. Use with the GNU Affero General Public License.

Notwithstanding any other provision of this License, you have permission to link or combine any covered work with a work licensed under version 3 of the GNU Affero General Public License into a single combined work, and to convey the resulting work. The terms of this License will continue to apply to the part which is the covered work,

but the special requirements of the GNU Affero General Public License, section 13, concerning interaction through a network will apply to the combination as such.

#### 14. Revised Versions of this License.

The Free Software Foundation may publish revised and/or new versions of the GNU General Public License from time to time. Such new versions will be similar in spirit to the present version, but may differ in detail to address new problems or concerns.

Each version is given a distinguishing version number. If the Program specifies that a certain numbered version of the GNU General Public License "or any later version" applies to it, you have the option of following the terms and conditions either of that numbered version or of any later version published by the Free Software Foundation. If the Program does not specify a version number of the GNU General Public License, you may choose any version ever published by the Free Software Foundation.

If the Program specifies that a proxy can decide which future versions of the GNU General Public License can be used, that proxy's public statement of acceptance of a version permanently authorizes you to choose that version for the Program.

Later license versions may give you additional or different permissions. However, no additional obligations are imposed on any author or copyright holder as a result of your choosing to follow a later version.

#### 15. Disclaimer of Warranty.

THERE IS NO WARRANTY FOR THE PROGRAM, TO THE EXTENT PERMITTED BY APPLICABLE LAW. EXCEPT WHEN OTHERWISE STATED IN WRITING THE COPYRIGHT HOLDERS AND/OR OTHER PARTIES PROVIDE THE PROGRAM "AS IS" WITHOUT WARRANTY OF ANY KIND, EITHER EXPRESSED OR IMPLIED, INCLUDING, BUT NOT LIMITED TO, THE IMPLIED WARRANTIES OF MERCHANTABILITY AND FITNESS FOR A PARTICULAR PURPOSE. THE ENTIRE RISK AS TO THE QUALITY AND PERFORMANCE OF THE PROGRAM IS WITH YOU. SHOULD THE PROGRAM PROVE DEFECTIVE, YOU ASSUME THE COST OF ALL NECESSARY SERVICING, REPAIR OR CORRECTION.

#### 16. Limitation of Liability.

IN NO EVENT UNLESS REQUIRED BY APPLICABLE LAW OR AGREED TO IN WRITING WILL ANY COPYRIGHT HOLDER, OR ANY OTHER PARTY WHO MODIFIES AND/OR CONVEYS THE PROGRAM AS PERMITTED ABOVE, BE LIABLE TO YOU FOR DAMAGES, INCLUDING ANY GENERAL, SPECIAL, INCIDENTAL OR CONSEQUENTIAL DAMAGES ARISING OUT OF THE USE OR INABILITY TO USE THE PROGRAM (INCLUDING BUT NOT LIMITED TO LOSS OF DATA OR DATA BEING RENDERED INACCURATE OR LOSSES SUSTAINED BY YOU OR THIRD PARTIES OR A FAILURE OF THE PROGRAM TO OPERATE WITH ANY OTHER PROGRAMS), EVEN IF SUCH HOLDER OR OTHER PARTY HAS BEEN ADVISED OF THE POSSIBILITY OF SUCH DAMAGES.

#### 17. Interpretation of Sections 15 and 16.

If the disclaimer of warranty and limitation of liability provided

above cannot be given local legal effect according to their terms, reviewing courts shall apply local law that most closely approximates an absolute waiver of all civil liability in connection with the Program, unless a warranty or assumption of liability accompanies a copy of the Program in return for a fee.

#### END OF TERMS AND CONDITIONS

#### How to Apply These Terms to Your New Programs

If you develop a new program, and you want it to be of the greatest possible use to the public, the best way to achieve this is to make it free software which everyone can redistribute and change under these terms.

To do so, attach the following notices to the program. It is safest to attach them to the start of each source file to most effectively state the exclusion of warranty; and each file should have at least the "copyright" line and a pointer to where the full notice is found.

```
<one line to give the program's name and a brief idea of what it does.>  
Copyright (C) <year> <name of author>
```

```
This program is free software: you can redistribute it and/or modify  
it under the terms of the GNU General Public License as published by  
the Free Software Foundation, either version 3 of the License, or  
(at your option) any later version.
```

```
This program is distributed in the hope that it will be useful,  
but WITHOUT ANY WARRANTY; without even the implied warranty of  
MERCHANTABILITY or FITNESS FOR A PARTICULAR PURPOSE. See the  
GNU General Public License for more details.
```

```
You should have received a copy of the GNU General Public License  
along with this program. If not, see <http://www.gnu.org/licenses/>.
```

Also add information on how to contact you by electronic and paper mail.

If the program does terminal interaction, make it output a short notice like this when it starts in an interactive mode:

```
<program> Copyright (C) <year> <name of author>  
This program comes with ABSOLUTELY NO WARRANTY; for details type `show w'.  
This is free software, and you are welcome to redistribute it  
under certain conditions; type `show c' for details.
```

The hypothetical commands `show w' and `show c' should show the appropriate parts of the General Public License. Of course, your program's commands might be different; for a GUI interface, you would use an "about box".

You should also get your employer (if you work as a programmer) or school, if any, to sign a "copyright disclaimer" for the program, if necessary. For more information on this, and how to apply and follow the GNU GPL, see <<http://www.gnu.org/licenses/>>.

The GNU General Public License does not permit incorporating your program into proprietary programs. If your program is a subroutine library, you

may consider it more useful to permit linking proprietary applications with the library. If this is what you want to do, use the GNU Lesser General Public License instead of this License. But first, please read <http://www.gnu.org/philosophy/why-not-lgpl.html>.

## 7.2 Eclipse Public License

Eclipse Public License, Version 1.0 (EPL-1.0)

THE ACCOMPANYING PROGRAM IS PROVIDED UNDER THE TERMS OF THIS ECLIPSE PUBLIC LICENSE ("AGREEMENT"). ANY USE, REPRODUCTION OR DISTRIBUTION OF THE PROGRAM CONSTITUTES RECIPIENT'S ACCEPTANCE OF THIS AGREEMENT.

### 1. DEFINITIONS

"Contribution" means:

- a) in the case of the initial Contributor, the initial code and documentation distributed under this Agreement, and
- b) in the case of each subsequent Contributor:
  - i) changes to the Program, and
  - ii) additions to the Program;

where such changes and/or additions to the Program originate from and are distributed by that particular Contributor. A Contribution 'originates' from a Contributor if it was added to the Program by such Contributor itself or anyone acting on such Contributor's behalf. Contributions do not include additions to the Program which: (i) are separate modules of software distributed in conjunction with the Program under their own license agreement, and (ii) are not derivative works of the Program.

"Contributor" means any person or entity that distributes the Program.

"Licensed Patents " mean patent claims licensable by a Contributor which are necessarily infringed by the use or sale of its Contribution alone or when combined with the Program.

"Program" means the Contributions distributed in accordance with this Agreement.

"Recipient" means anyone who receives the Program under this Agreement, including all Contributors.

## 2. GRANT OF RIGHTS

a) Subject to the terms of this Agreement, each Contributor hereby grants Recipient a non-exclusive, worldwide, royalty-free copyright license to reproduce, prepare derivative works of, publicly display, publicly perform, distribute and sublicense the Contribution of such Contributor, if any, and such derivative works, in source code and object code form.

b) Subject to the terms of this Agreement, each Contributor hereby grants Recipient a non-exclusive, worldwide, royalty-free patent license under Licensed Patents to make, use, sell, offer to sell, import and otherwise transfer the Contribution of such Contributor, if any, in source code and object code form. This patent license shall apply to the combination of the Contribution and the Program if, at the time the Contribution is added by the Contributor, such addition of the Contribution causes such combination to be covered by the Licensed Patents. The patent license shall not apply to any other combinations which include the Contribution. No hardware per se is licensed hereunder.

c) Recipient understands that although each Contributor grants the licenses to its Contributions set forth herein, no assurances are provided by any Contributor that the Program does not infringe the patent or other intellectual property rights of any other entity. Each Contributor disclaims any liability to Recipient for claims brought by any other entity based on infringement of intellectual property rights or otherwise. As a condition to exercising the rights and licenses granted hereunder, each Recipient hereby assumes sole responsibility to secure any other intellectual property rights needed, if any. For example, if a third party patent license is required to allow Recipient to distribute the Program, it is Recipient's responsibility to acquire that license before distributing the Program.

d) Each Contributor represents that to its knowledge it has sufficient copyright rights in its Contribution, if any, to grant the copyright license set forth in this Agreement.

## 3. REQUIREMENTS

A Contributor may choose to distribute the Program in object code form under its own license agreement, provided that:

a) it complies with the terms and conditions of this Agreement; and

b) its license agreement:

i) effectively disclaims on behalf of all Contributors all warranties and conditions, express and implied, including warranties or conditions of title and non-infringement, and implied warranties or conditions of merchantability and fitness for a particular purpose;

ii) effectively excludes on behalf of all Contributors all liability for damages, including direct, indirect, special, incidental and consequential damages, such as lost profits;

iii) states that any provisions which differ from this Agreement are offered by that Contributor alone and not by any other party; and

iv) states that source code for the Program is available from such Contributor, and informs licensees how to obtain it in a reasonable manner on or through a medium customarily used for software exchange.

When the Program is made available in source code form:

a) it must be made available under this Agreement; and

b) a copy of this Agreement must be included with each copy of the Program.

Contributors may not remove or alter any copyright notices contained within the Program.

Each Contributor must identify itself as the originator of its Contribution, if any, in a manner that reasonably allows subsequent Recipients to identify the originator of the Contribution.



#### 4. COMMERCIAL DISTRIBUTION

Commercial distributors of software may accept certain responsibilities with respect to end users, business partners and the like. While this license is intended to facilitate the commercial use of the Program, the Contributor who includes the Program in a commercial product offering should do so in a manner which does not create potential liability for other Contributors. Therefore, if a Contributor includes the Program in a commercial product offering, such Contributor ("Commercial Contributor") hereby agrees to defend and indemnify every other Contributor ("Indemnified Contributor") against any losses, damages and costs (collectively "Losses") arising from claims, lawsuits and other legal actions brought by a third party against the Indemnified Contributor to the extent caused by the acts or omissions of such Commercial Contributor in connection with its distribution of the Program in a commercial product offering. The obligations in this section do not apply to any claims or Losses relating to any actual or alleged intellectual property infringement. In order to qualify, an Indemnified Contributor must: a) promptly notify the Commercial Contributor in writing of such claim, and b) allow the Commercial Contributor to control, and cooperate with the Commercial Contributor in, the defense and any related settlement negotiations. The Indemnified Contributor may participate in any such claim at its own expense.

For example, a Contributor might include the Program in a commercial product offering, Product X. That Contributor is then a Commercial Contributor. If that Commercial Contributor then makes performance claims, or offers warranties related to Product X, those performance claims and warranties are such Commercial Contributor's responsibility alone. Under this section, the Commercial Contributor would have to defend claims against the other Contributors related to those performance claims and warranties, and if a court requires any other Contributor to pay any damages as a result, the Commercial Contributor must pay those damages.

#### 5. NO WARRANTY

EXCEPT AS EXPRESSLY SET FORTH IN THIS AGREEMENT, THE PROGRAM IS PROVIDED ON AN "AS IS" BASIS, WITHOUT WARRANTIES OR CONDITIONS OF ANY KIND, EITHER EXPRESS OR IMPLIED INCLUDING, WITHOUT LIMITATION, ANY WARRANTIES OR CONDITIONS OF TITLE, NON-INFRINGEMENT, MERCHANTABILITY OR FITNESS FOR A PARTICULAR PURPOSE. Each Recipient is solely responsible for determining the appropriateness of using and distributing the Program and assumes all risks associated with its exercise of rights under this Agreement, including but not limited to the risks and costs of program errors, compliance with applicable laws, damage to or loss of data, programs or equipment, and unavailability or interruption of operations.

#### 6. DISCLAIMER OF LIABILITY

EXCEPT AS EXPRESSLY SET FORTH IN THIS AGREEMENT, NEITHER RECIPIENT NOR ANY CONTRIBUTORS SHALL HAVE ANY LIABILITY FOR ANY DIRECT, INDIRECT, INCIDENTAL, SPECIAL, EXEMPLARY, OR CONSEQUENTIAL DAMAGES (INCLUDING WITHOUT LIMITATION LOST PROFITS), HOWEVER CAUSED AND ON ANY THEORY OF LIABILITY, WHETHER IN CONTRACT, STRICT LIABILITY, OR TORT (INCLUDING NEGLIGENCE OR OTHERWISE) ARISING IN ANY WAY OUT OF THE USE OR DISTRIBUTION OF THE PROGRAM OR THE EXERCISE OF ANY RIGHTS GRANTED HEREUNDER, EVEN IF ADVISED OF THE POSSIBILITY OF SUCH DAMAGES.

## 7. GENERAL

If any provision of this Agreement is invalid or unenforceable under applicable law, it shall not affect the validity or enforceability of the remainder of the terms of this Agreement, and without further action by the parties hereto, such provision shall be reformed to the minimum extent necessary to make such provision valid and enforceable.

If Recipient institutes patent litigation against any entity (including a cross-claim or counterclaim in a lawsuit) alleging that the Program itself (excluding combinations of the Program with other software or hardware) infringes such Recipient's patent(s), then such Recipient's rights granted under Section 2(b) shall terminate as of the date such litigation is filed.

All Recipient's rights under this Agreement shall terminate if it fails to comply with any of the material terms or conditions of this Agreement and does not cure such failure in a reasonable period of time after becoming aware of such noncompliance. If all Recipient's rights under this Agreement terminate, Recipient agrees to cease use and distribution of the Program as soon as reasonably practicable. However, Recipient's obligations under this Agreement and any licenses granted by Recipient relating to the Program shall continue and survive.

Everyone is permitted to copy and distribute copies of this Agreement, but in order to avoid inconsistency the Agreement is copyrighted and may only be modified in the following manner. The Agreement Steward reserves the right to publish new versions (including revisions) of this Agreement from time to time. No one other than the Agreement Steward has the right to modify this Agreement. The Eclipse Foundation is the initial Agreement Steward. The Eclipse Foundation may assign the responsibility to serve as the Agreement Steward to a suitable separate entity. Each new version of the Agreement will be given a distinguishing version number. The Program (including Contributions) may always be distributed subject to the version of the Agreement under which it was received. In addition, after a new version of the Agreement is published, Contributor may elect to distribute the Program (including its Contributions) under the new version. Except as expressly stated in Sections 2(a) and 2(b) above, Recipient receives no rights or licenses to the intellectual property of any Contributor under this Agreement, whether expressly, by implication, estoppel or otherwise. All rights in the Program not expressly granted under this Agreement are reserved.

This Agreement is governed by the laws of the State of New York and the intellectual property laws of the United States of America. No party to this Agreement will bring a legal action under this Agreement more than one year after the cause of action arose. Each party waives its rights to a jury trial in any resulting litigation.

## 7.3 Python Public License

Python 2.5 license

This is the official license for the Python 2.5 release:

A. HISTORY OF THE SOFTWARE

=====

Python was created in the early 1990s by Guido van Rossum at Stichting Mathematisch Centrum (CWI, see <http://www.cwi.nl>) in the Netherlands as a successor of a language called ABC. Guido remains Python's principal author, although it includes many contributions from others. In 1995, Guido continued his work on Python at the Corporation for National Research Initiatives (CNRI, see <http://www.cnri.reston.va.us>) in Reston, Virginia where he released several versions of the software.

In May 2000, Guido and the Python core development team moved to BeOpen.com to form the BeOpen PythonLabs team. In October of the same year, the PythonLabs team moved to Digital Creations (now Zope Corporation, see <http://www.zope.com>). In 2001, the Python Software Foundation (PSF, see <http://www.python.org/psf/>) was formed, a non-profit organization created specifically to own Python-related Intellectual Property. Zope Corporation is a sponsoring member of the PSF.

All Python releases are Open Source (see <http://www.opensource.org> for the Open Source Definition). Historically, most, but not all, Python releases have also been GPL-compatible; the table below summarizes the various releases.

Release	Derived from	Year	Owner	GPL-compatible? (1)
0.9.0 thru 1.2		1991-1995	CWI	yes
1.3 thru 1.5.2	1.2	1995-1999	CNRI	yes
1.6	1.5.2	2000	CNRI	no
2.0	1.6	2000	BeOpen.com	no
1.6.1	1.6	2001	CNRI	yes (2)
2.1	2.0+1.6.1	2001	PSF	no
2.0.1	2.0+1.6.1	2001	PSF	yes
2.1.1	2.1+2.0.1	2001	PSF	yes
2.2	2.1.1	2001	PSF	yes
2.1.2	2.1.1	2002	PSF	yes
2.1.3	2.1.2	2002	PSF	yes
2.2.1	2.2	2002	PSF	yes
2.2.2	2.2.1	2002	PSF	yes
2.2.3	2.2.2	2003	PSF	yes
2.3	2.2.2	2002-2003	PSF	yes
2.3.1	2.3	2002-2003	PSF	yes
2.3.2	2.3.1	2002-2003	PSF	yes
2.3.3	2.3.2	2002-2003	PSF	yes
2.3.4	2.3.3	2004	PSF	yes
2.3.5	2.3.4	2005	PSF	yes
2.4	2.3	2004	PSF	yes
2.4.1	2.4	2005	PSF	yes
2.4.2	2.4.1	2005	PSF	yes
2.4.3	2.4.2	2006	PSF	yes
2.5	2.4	2006	PSF	yes

Footnotes:

- (1) GPL-compatible doesn't mean that we're distributing Python under the GPL. All Python licenses, unlike the GPL, let you distribute a modified version without making your changes open source. The GPL-compatible licenses make it possible to combine Python with other software that is released under the GPL; the others don't.
- (2) According to Richard Stallman, 1.6.1 is not GPL-compatible, because its license has a choice of law clause. According to CNRI, however, Stallman's lawyer has told CNRI's lawyer that 1.6.1 is "not incompatible" with the GPL.

Thanks to the many outside volunteers who have worked under Guido's direction to make these releases possible.

B. TERMS AND CONDITIONS FOR ACCESSING OR OTHERWISE USING PYTHON

=====

PYTHON SOFTWARE FOUNDATION LICENSE VERSION 2

-----

1. This LICENSE AGREEMENT is between the Python Software Foundation ("PSF"), and the Individual or Organization ("Licensee") accessing and otherwise using this software ("Python") in source or binary form and its associated documentation.

2. Subject to the terms and conditions of this License Agreement, PSF hereby grants Licensee a nonexclusive, royalty-free, world-wide license to reproduce, analyze, test, perform and/or display publicly, prepare derivative works, distribute, and otherwise use Python alone or in any derivative version, provided, however, that PSF's License Agreement and PSF's notice of copyright, i.e., "Copyright (c) 2001, 2002, 2003, 2004, 2005, 2006 Python Software Foundation; All Rights Reserved" are retained in Python alone or in any derivative version prepared by Licensee.

3. In the event Licensee prepares a derivative work that is based on or incorporates Python or any part thereof, and wants to make the derivative work available to others as provided herein, then Licensee hereby agrees to include in any such work a brief summary of the changes made to Python.

4. PSF is making Python available to Licensee on an "AS IS" basis. PSF MAKES NO REPRESENTATIONS OR WARRANTIES, EXPRESS OR IMPLIED. BY WAY OF EXAMPLE, BUT NOT LIMITATION, PSF MAKES NO AND DISCLAIMS ANY REPRESENTATION OR WARRANTY OF MERCHANTABILITY OR FITNESS FOR ANY PARTICULAR PURPOSE OR THAT THE USE OF PYTHON WILL NOT INFRINGE ANY THIRD PARTY RIGHTS.

5. PSF SHALL NOT BE LIABLE TO LICENSEE OR ANY OTHER USERS OF PYTHON FOR ANY INCIDENTAL, SPECIAL, OR CONSEQUENTIAL DAMAGES OR LOSS AS A RESULT OF MODIFYING, DISTRIBUTING, OR OTHERWISE USING PYTHON, OR ANY DERIVATIVE THEREOF, EVEN IF ADVISED OF THE POSSIBILITY THEREOF.

6. This License Agreement will automatically terminate upon a material breach of its terms and conditions.

7. Nothing in this License Agreement shall be deemed to create any relationship of agency, partnership, or joint venture between PSF and Licensee. This License Agreement does not grant permission to use PSF trademarks or trade name in a trademark sense to endorse or promote products or services of Licensee, or any third party.

8. By copying, installing or otherwise using Python, Licensee agrees to be bound by the terms and conditions of this License Agreement.

BEOPEN.COM LICENSE AGREEMENT FOR PYTHON 2.0  
-----

BEOPEN PYTHON OPEN SOURCE LICENSE AGREEMENT VERSION 1

1. This LICENSE AGREEMENT is between BeOpen.com ("BeOpen"), having an office at 160 Saratoga Avenue, Santa Clara, CA 95051, and the Individual or Organization ("Licensee") accessing and otherwise using this software in source or binary form and its associated documentation ("the Software").

2. Subject to the terms and conditions of this BeOpen Python License Agreement, BeOpen hereby grants Licensee a non-exclusive, royalty-free, world-wide license to reproduce, analyze, test, perform and/or display publicly, prepare derivative works, distribute, and otherwise use the Software alone or in any derivative version, provided, however, that the BeOpen Python License is retained in the Software, alone or in any derivative version prepared by Licensee.

3. BeOpen is making the Software available to Licensee on an "AS IS" basis. BEOPEN MAKES NO REPRESENTATIONS OR WARRANTIES, EXPRESS OR IMPLIED. BY WAY OF EXAMPLE, BUT NOT LIMITATION, BEOPEN MAKES NO AND DISCLAIMS ANY REPRESENTATION OR WARRANTY OF MERCHANTABILITY OR FITNESS FOR ANY PARTICULAR PURPOSE OR THAT THE USE OF THE SOFTWARE WILL NOT INFRINGE ANY THIRD PARTY RIGHTS.

4. BEOPEN SHALL NOT BE LIABLE TO LICENSEE OR ANY OTHER USERS OF THE SOFTWARE FOR ANY INCIDENTAL, SPECIAL, OR CONSEQUENTIAL DAMAGES OR LOSS AS A RESULT OF USING, MODIFYING OR DISTRIBUTING THE SOFTWARE, OR ANY DERIVATIVE THEREOF, EVEN IF ADVISED OF THE POSSIBILITY THEREOF.

5. This License Agreement will automatically terminate upon a material breach of its terms and conditions.

6. This License Agreement shall be governed by and interpreted in all respects by the law of the State of California, excluding conflict of law provisions. Nothing in this License Agreement shall be deemed to create any relationship of agency, partnership, or joint venture between BeOpen and Licensee. This License Agreement does not grant permission to use BeOpen trademarks or trade names in a trademark sense to endorse or promote products or services of Licensee, or any third party. As an exception, the "BeOpen Python" logos available at <http://www.pythonlabs.com/logos.html> may be used according to the permissions granted on that web page.

7. By copying, installing or otherwise using the software, Licensee agrees to be bound by the terms and conditions of this License Agreement.

CNRI LICENSE AGREEMENT FOR PYTHON 1.6.1  
-----

1. This LICENSE AGREEMENT is between the Corporation for National Research Initiatives, having an office at 1895 Preston White Drive, Reston, VA 20191 ("CNRI"), and the Individual or Organization ("Licensee") accessing and otherwise using Python 1.6.1 software in source or binary form and its associated documentation.

2. Subject to the terms and conditions of this License Agreement, CNRI hereby grants Licensee a nonexclusive, royalty-free, world-wide license to reproduce, analyze, test, perform and/or display publicly, prepare derivative works, distribute, and otherwise use Python 1.6.1 alone or in any derivative version, provided, however, that CNRI's License Agreement and CNRI's notice of copyright, i.e., "Copyright (c) 1995-2001 Corporation for National Research Initiatives; All Rights Reserved" are retained in Python 1.6.1 alone or in any derivative version prepared by Licensee. Alternately, in lieu of CNRI's License Agreement, Licensee may substitute the following text (omitting the quotes): "Python 1.6.1 is made available subject to the terms and conditions in CNRI's License Agreement. This Agreement together with Python 1.6.1 may be located on the Internet using the following unique, persistent identifier (known as a handle): 1895.22/1013. This Agreement may also be obtained from a proxy server on the Internet using the following URL: <http://hdl.handle.net/1895.22/1013>".

3. In the event Licensee prepares a derivative work that is based on or incorporates Python 1.6.1 or any part thereof, and wants to make the derivative work available to others as provided herein, then Licensee hereby agrees to include in any such work a brief summary of the changes made to Python 1.6.1.

4. CNRI is making Python 1.6.1 available to Licensee on an "AS IS" basis. CNRI MAKES NO REPRESENTATIONS OR WARRANTIES, EXPRESS OR IMPLIED. BY WAY OF EXAMPLE, BUT NOT LIMITATION, CNRI MAKES NO AND DISCLAIMS ANY REPRESENTATION OR WARRANTY OF MERCHANTABILITY OR FITNESS FOR ANY PARTICULAR PURPOSE OR THAT THE USE OF PYTHON 1.6.1 WILL NOT INFRINGE ANY THIRD PARTY RIGHTS.

5. CNRI SHALL NOT BE LIABLE TO LICENSEE OR ANY OTHER USERS OF PYTHON 1.6.1 FOR ANY INCIDENTAL, SPECIAL, OR CONSEQUENTIAL DAMAGES OR LOSS AS A RESULT OF MODIFYING, DISTRIBUTING, OR OTHERWISE USING PYTHON 1.6.1, OR ANY DERIVATIVE THEREOF, EVEN IF ADVISED OF THE POSSIBILITY THEREOF.

6. This License Agreement will automatically terminate upon a material breach of its terms and conditions.

7. This License Agreement shall be governed by the federal intellectual property law of the United States, including without limitation the federal copyright law, and, to the extent such U.S. federal law does not apply, by the law of the Commonwealth of Virginia, excluding Virginia's conflict of law provisions. Notwithstanding the foregoing, with regard to derivative works based on Python 1.6.1 that incorporate non-separable material that was previously distributed under the GNU General Public License (GPL), the law of the Commonwealth of Virginia shall govern this License Agreement only as to issues arising under or with respect to Paragraphs 4, 5, and 7 of this License Agreement. Nothing in this License Agreement shall be deemed to create any relationship of agency, partnership, or joint venture between CNRI and Licensee. This License Agreement does not grant permission to use CNRI trademarks or trade name in a trademark sense to endorse or promote products or services of Licensee, or any third party.

8. By clicking on the "ACCEPT" button where indicated, or by copying, installing or otherwise using Python 1.6.1, Licensee agrees to be bound by the terms and conditions of this License Agreement.

ACCEPT

CWI LICENSE AGREEMENT FOR PYTHON 0.9.0 THROUGH 1.2  
-----

Copyright (c) 1991 - 1995, Stichting Mathematisch Centrum Amsterdam, The Netherlands. All rights reserved.

Permission to use, copy, modify, and distribute this software and its documentation for any purpose and without fee is hereby granted, provided that the above copyright notice appear in all copies and that both that copyright notice and this permission notice appear in supporting documentation, and that the name of Stichting Mathematisch Centrum or CWI not be used in advertising or publicity pertaining to distribution of the software without specific, written prior permission.

STICHTING MATHEMATISCH CENTRUM DISCLAIMS ALL WARRANTIES WITH REGARD TO THIS SOFTWARE, INCLUDING ALL IMPLIED WARRANTIES OF MERCHANTABILITY AND FITNESS, IN NO EVENT SHALL STICHTING MATHEMATISCH CENTRUM BE LIABLE FOR ANY SPECIAL, INDIRECT OR CONSEQUENTIAL DAMAGES OR ANY DAMAGES WHATSOEVER RESULTING FROM LOSS OF USE, DATA OR PROFITS, WHETHER IN AN ACTION OF CONTRACT, NEGLIGENCE OR OTHER TORTIOUS ACTION, ARISING OUT OF OR IN CONNECTION WITH THE USE OR PERFORMANCE OF THIS SOFTWARE.

## 7.4 GCC Public License

The Code: GPL

The source code is distributed under the GNU General Public License version 3, with the addition under section 7 of an exception described in the GCC Runtime Library Exception, version 3.1 as follows (or see the file COPYING.RUNTIME):

### GCC RUNTIME LIBRARY EXCEPTION

Version 3.1, 31 March 2009

Copyright (C) 2009 Free Software Foundation, Inc.

This GCC Runtime Library Exception ("Exception") is an additional permission under section 7 of the GNU General Public License, version 3 ("GPLv3"). It applies to a given file (the "Runtime Library") that bears a notice placed by the copyright holder of the file stating that the file is governed by GPLv3 along with this Exception.

When you use GCC to compile a program, GCC may combine portions of certain GCC header files and runtime libraries with the compiled program. The purpose of this Exception is to allow compilation of non-GPL (including proprietary) programs to use, in this way, the header files and runtime libraries covered by this Exception.

#### 0. Definitions.

A file is an "Independent Module" if it either requires the Runtime Library for execution after a Compilation Process, or makes use of an interface provided by the Runtime Library, but is not otherwise based on the Runtime Library.

"GCC" means a version of the GNU Compiler Collection, with or without modifications, governed by version 3 (or a specified later version) of the GNU General Public License (GPL) with the option of using any subsequent versions published by the FSF.

"GPL-compatible Software" is software whose conditions of propagation, modification and use would permit combination with GCC in accord with the license of GCC.

"Target Code" refers to output from any compiler for a real or virtual target processor architecture, in executable form or suitable for input to an assembler, loader, linker and/or execution phase. Notwithstanding that, Target Code does not include data in any format that is used as a compiler intermediate representation, or used for producing a compiler intermediate representation.

The "Compilation Process" transforms code entirely represented in non-intermediate languages designed for human-written code, and/or in Java Virtual Machine byte code, into Target Code. Thus, for example, use of source code generators and preprocessors need not be considered part of the Compilation Process, since the Compilation Process can be understood as starting with the output of the generators or preprocessors.



A Compilation Process is "Eligible" if it is done using GCC, alone or with other GPL-compatible software, or if it is done without using any work based on GCC. For example, using non-GPL-compatible Software to optimize any GCC intermediate representations would not qualify as an Eligible Compilation Process.

1. Grant of Additional Permission.

You have permission to propagate a work of Target Code formed by combining the Runtime Library with Independent Modules, even if such propagation would otherwise violate the terms of GPLv3, provided that all Target Code was generated by Eligible Compilation Processes. You may then convey such a combination under terms of your choice, consistent with the licensing of the Independent Modules.

2. No Weakening of GCC Copyleft. The availability of this Exception does not imply any general presumption that third-party software is unaffected by the copyleft requirements of the license of GCC.

The Documentation: GPL, FDL

The documentation shipped with the library and made available over the web, excluding the pages generated from source comments, are copyrighted by the Free Software Foundation, and placed under the GNU Free Documentation License version 1.3. There are no Front-Cover Texts, no Back-Cover Texts, and no Invariant Sections.

For documentation generated by doxygen or other automated tools via processing source code comments and markup, the original source code license applies to the generated files. Thus, the doxygen documents are licensed GPL.

## 8 Support, Service & Warranty

### 8.1 Contacting Technical Support

ProSoft Technology, Inc. is committed to providing the most efficient and effective support possible. Before calling, please gather the following information to assist in expediting this process:

- 1 Product Version Number
- 2 System architecture
- 3 Network details

If the issue is hardware related, we will also need information regarding:

- 1 Module configuration and associated ladder files, if any
- 2 Module operation and any unusual behavior
- 3 Configuration/Debug status information
- 4 LED patterns
- 5 Details about the interfaced serial, Ethernet or Fieldbus devices

**Note:** For technical support calls within the United States, ProSoft's 24/7 after-hours phone support is available for urgent plant-down issues.

<b>North America (Corporate Location)</b>	<b>Europe / Middle East / Africa Regional Office</b>
Phone: +1.661.716.5100 info@prosoft-technology.com Languages spoken: English, Spanish REGIONAL TECH SUPPORT support@prosoft-technology.com	Phone: +33.(0)5.34.36.87.20 france@prosoft-technology.com Languages spoken: French, English REGIONAL TECH SUPPORT support.emea@prosoft-technology.com
<b>Latin America Regional Office</b>	<b>Asia Pacific Regional Office</b>
Phone: +52.222.264.1814 latinam@prosoft-technology.com Languages spoken: Spanish, English REGIONAL TECH SUPPORT support.la@prosoft-technology.com	Phone: +60.3.2247.1898 asiapc@prosoft-technology.com Languages spoken: Bahasa, Chinese, English, Japanese, Korean REGIONAL TECH SUPPORT support.ap@prosoft-technology.com

For additional ProSoft Technology contacts in your area, please visit:  
<https://www.prosoft-technology.com/About-Us/Contact-Us>.

### 8.2 Warranty Information

For complete details regarding ProSoft Technology's TERMS & CONDITIONS OF SALE, WARRANTY, SUPPORT, SERVICE AND RETURN MATERIAL AUTHORIZATION INSTRUCTIONS, please see the documents at:  
[www.prosoft-technology.com/legal](http://www.prosoft-technology.com/legal)

## 9 Glossary of Terms

### A

#### API

Application Program Interface

### B

#### BIOS

Basic Input Output System. The BIOS firmware initializes the module at power up, performs self-diagnostics, provides a DOS-compatible interface to the console, and flashes the ROM disk.

#### Byte

8-bit value

### C

#### CIP

Control and Information Protocol. This is the messaging protocol used for communications over the CompactLogix backplane. Refer to the ControlNet Specification for information.

#### Connection

A logical binding between two objects. A connection allows more efficient use of bandwidth, because the message path is not included after the connection is established.

#### Consumer

A destination for data.

#### Controller

The PLC or other controlling processor that communicates with the module directly over the backplane or via a network or remote I/O adapter.

### D

#### DLL

Dynamic Linked Library

### E

#### Embedded I/O

Refers to any I/O which may reside on a CAM board.

**ExplicitMsg**

An asynchronous message sent for information purposes to a node from the scanner.

**H**

**HSC**

High Speed Counter

**I**

**Input Image**

Refers to a contiguous block of data that is written by the module application and read by the controller. The input image is read by the controller once each scan. Also referred to as the input file.

**L**

**Library**

Refers to the library file containing the API functions. The library must be linked with the developer's application code to create the final executable program.

**Linked Library**

Dynamically Linked Library. See Library.

**Local I/O**

Refers to any I/O contained on the CPC base unit or mezzanine board.

**Long**

32-bit value.

**M**

**Module**

Refers to a module attached to the backplane.

**Mutex**

A system object which is used to provide mutually-exclusive access to a resource.

**O**

**Originator**

A client that establishes a connection path to a target.

**Output Image**

Table of output data sent to nodes on the network.

**P**

**Producer**

A source of data.

**PTO**

Pulse Train Output

**PTQ Suite**

The PTQ suite consists of line products for Schneider Electronics platforms:  
Quantum (ProTalk)

**S**

**Scanner**

A DeviceNet node that scans nodes on the network to update outputs and inputs.

**T**

**Target**

The end-node to which a connection is established by an originator.

**Thread**

Code that is executed within a process. A process may contain multiple threads.

**W**

**Word**

16-bit value